

図1-1 施設



図1-2 性別



図1-3 年齢

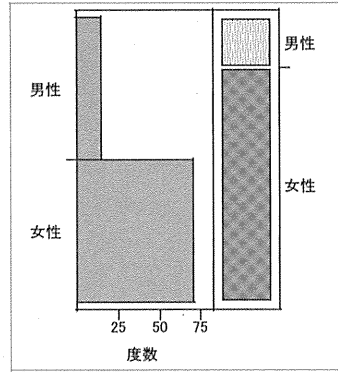

図1-4 要介護度

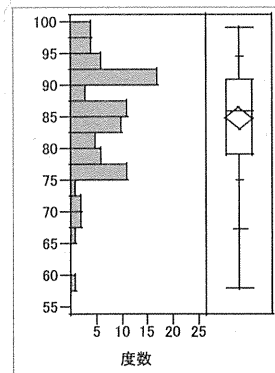

図1-5 施術内容

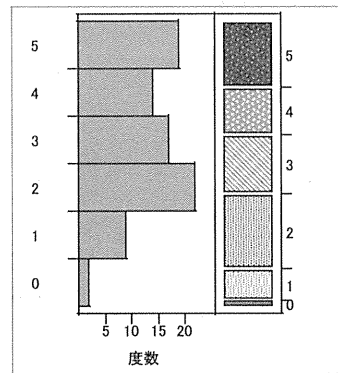

図1-6 施術時間

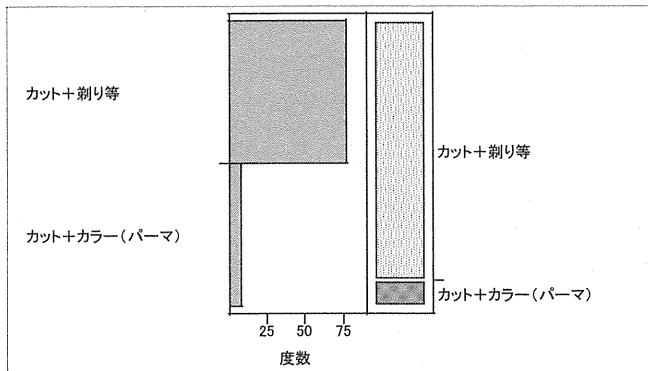

図1-7 要望者

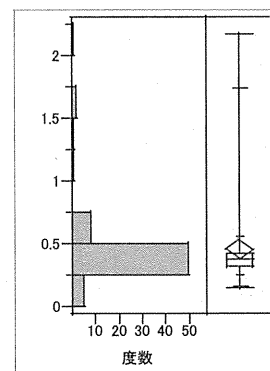

図1-8 施術頻度 (月/回)

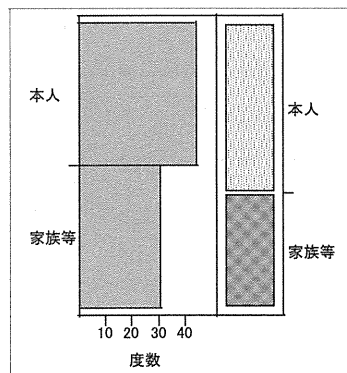

図1-9 施術内容と施術価格の関係

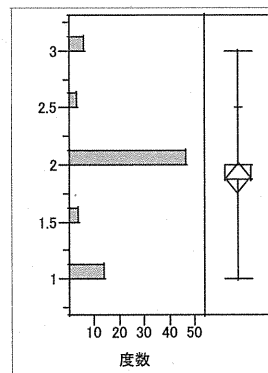

図1-10 カット+髭剃り等の場合の施術価格

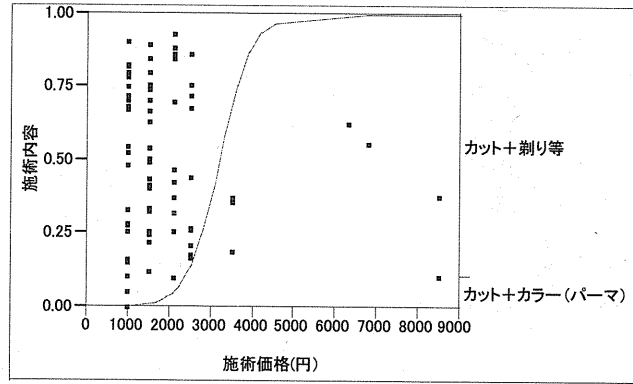

図1-11 カット+カラー(パーマ)の場合の施術価格

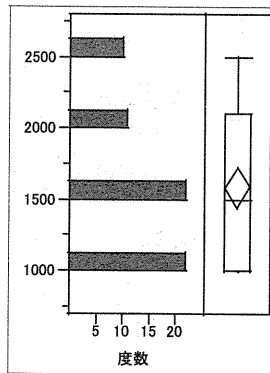

図1-12 年齢と要介護度の関係

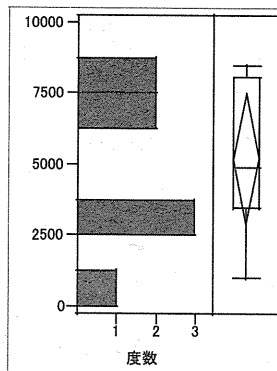

図1-13 性別と要介護度の関係

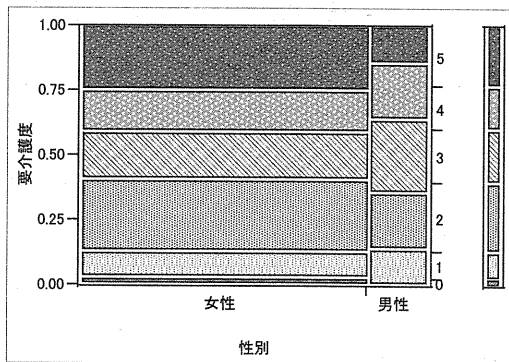

図1-14 施設と要介護度の関係

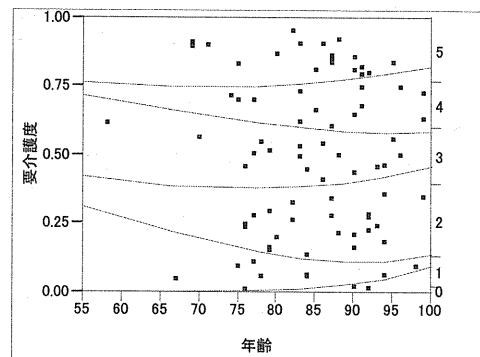

図1-15 施術時間と要介護度の関係

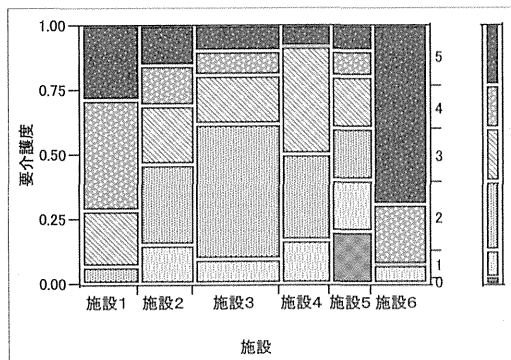

図1-16 職員介助の有無

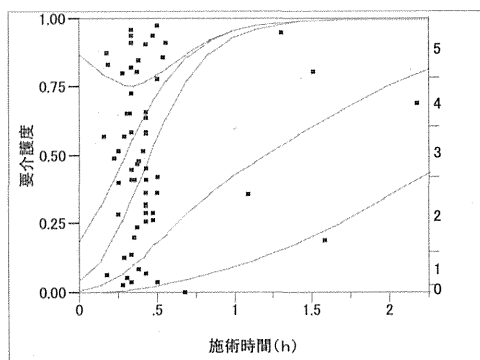

図1-17 職員介助の内容

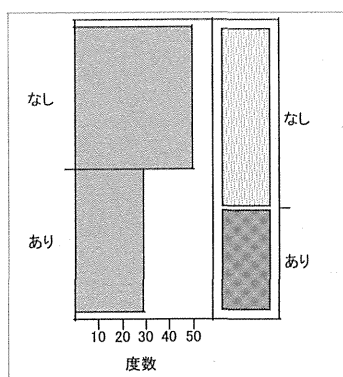

図1-18 施術中の座面の種類

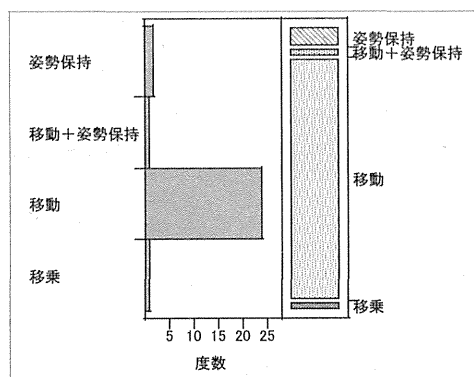

図1-19 施術中の姿勢

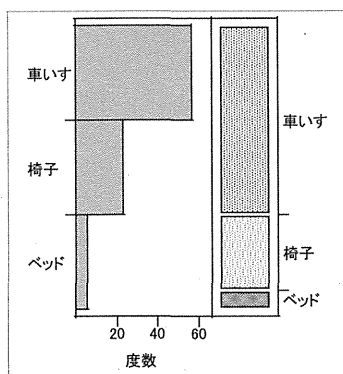

図1-20 施術中の理美容師との会話

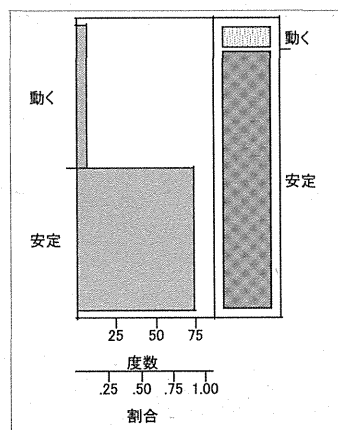

図1-21 施術中の理美容師との会話内容

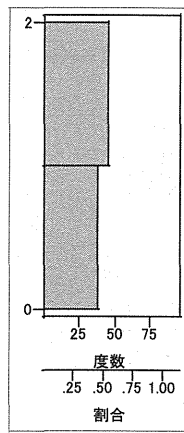

図1-22 施術中の表情

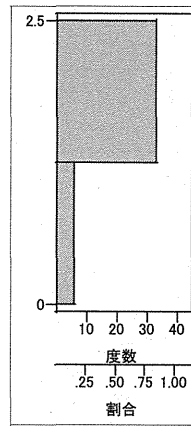

図1-23 施術後の気分

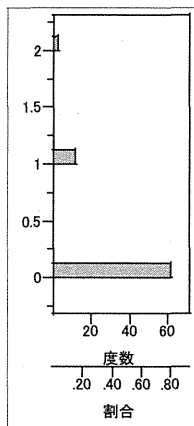

図1-24 施術後の疲れ

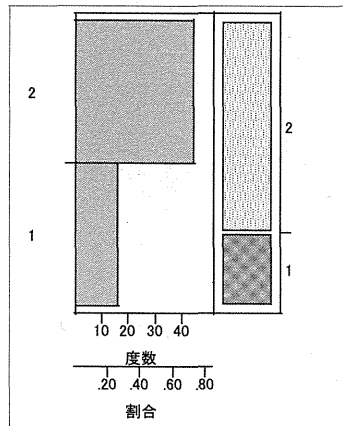

図1-25 施術後の痛み

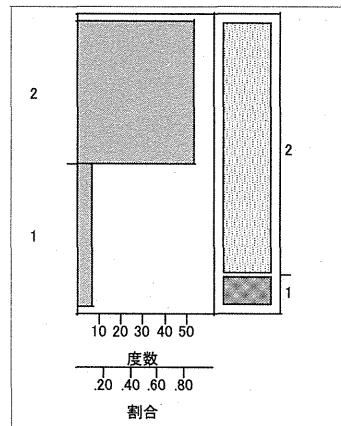

図1-26 出張理美容に対する意見

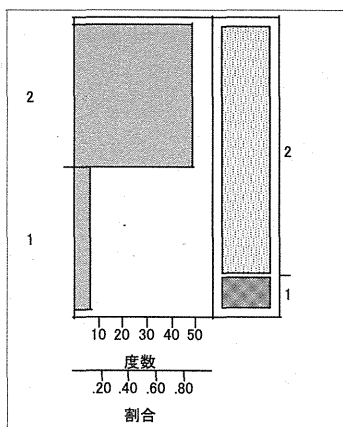

図1-27 理美容師に対する意見

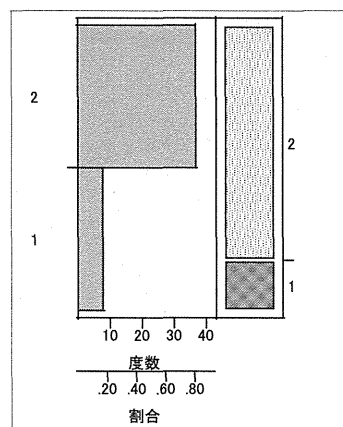

図1-28 施術場所に対する意見

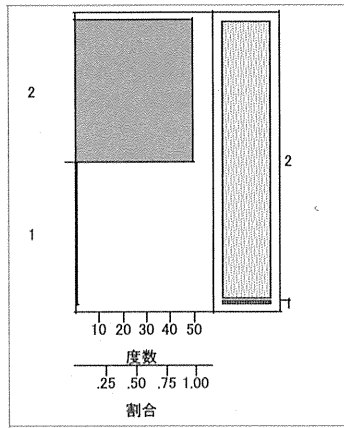

図1-29 施術後の気分と理美容師との会話

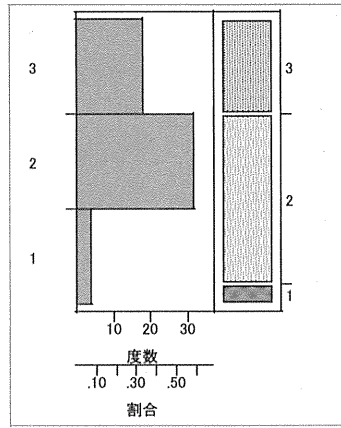

図1-30 施術後の疲れと理美容師との会話

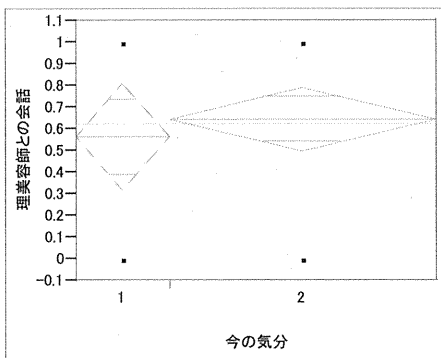

図1-31 施術後の痛みと理美容師との会話

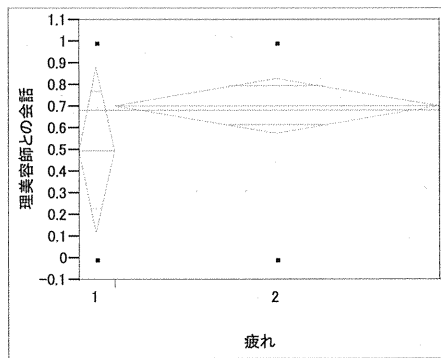

図1-32 移動手段と要介護度の関係

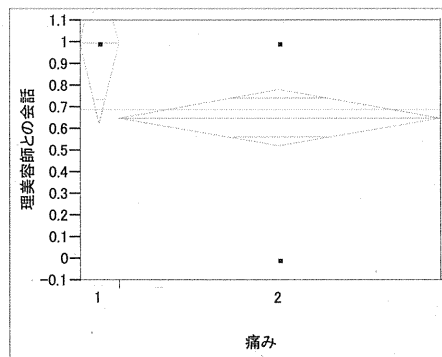

図1-33 施術内容と要介護度の関係

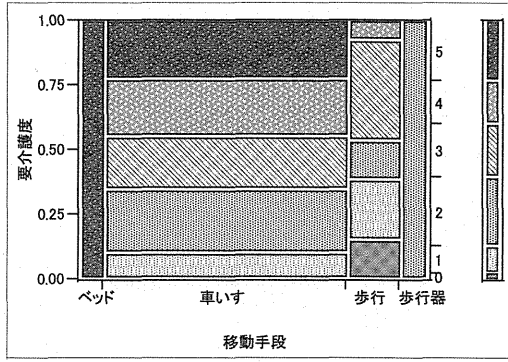

図1-34 要望者と要介護度の関係

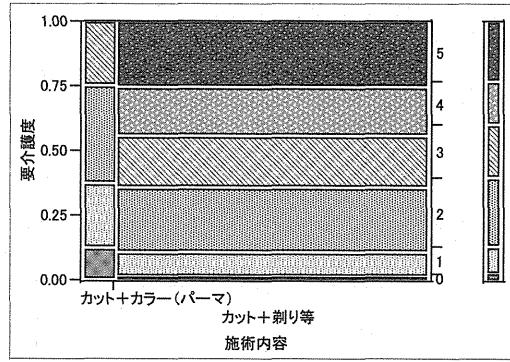

図1-35 施術頻度と要介護度の関係

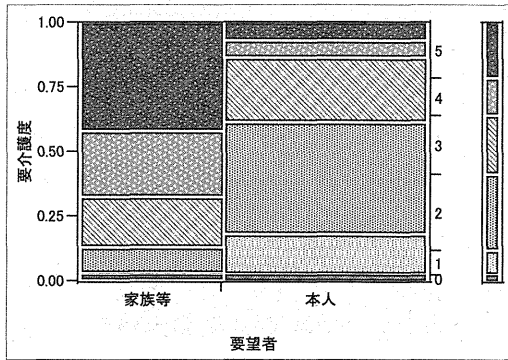

図1-36 理美容師との会話と要介護度の関係

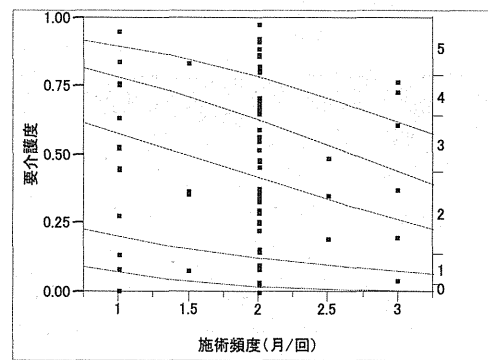

図1-37 理美容師との会話内容と要介護度の関係

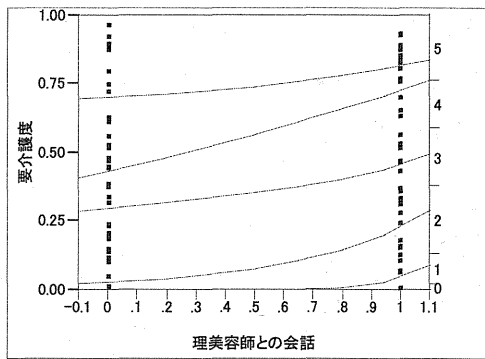

図1-38 施術中の姿勢等と要介護度の関係

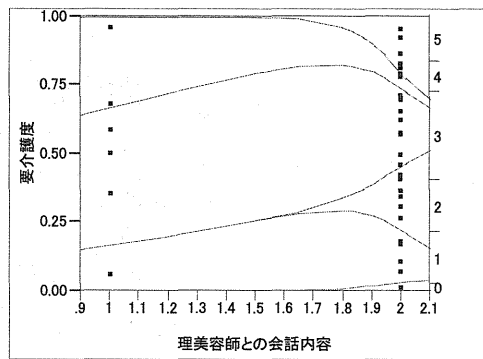

図1-39 施術中の表情と要介護度の関係

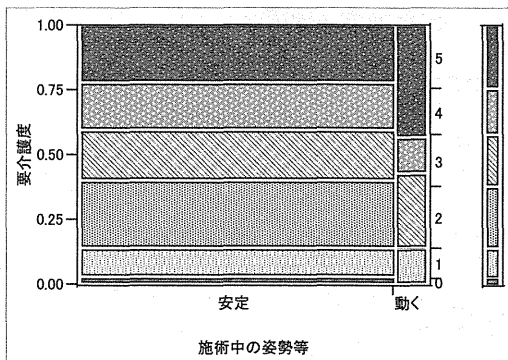

図1-40 施術後の気分と要介護度の関係

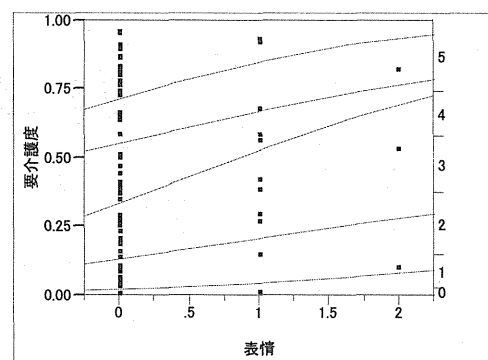

図1-41 施術後の疲れと要介護度の関係

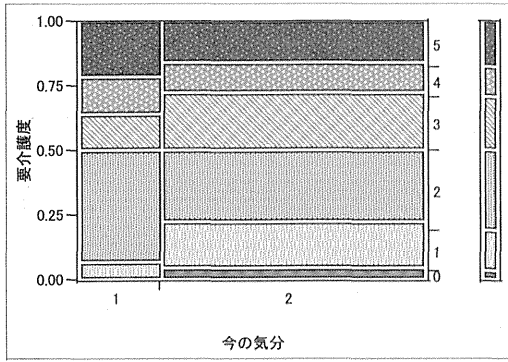

図1-42 施術後の痛みと要介護度の関係

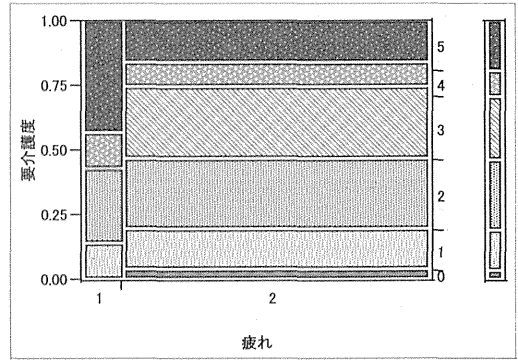

図1-43 出張理美容に対する意見と要介護度の関係

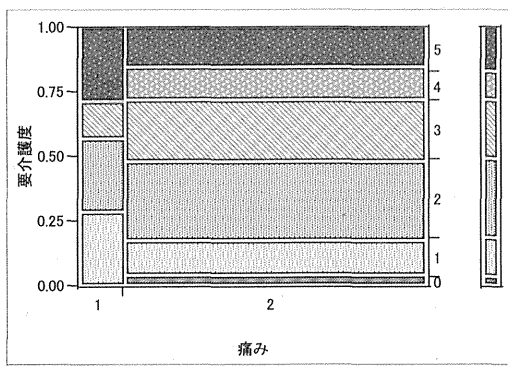

図1-44 理美容師に対する意見と要介護度の関係

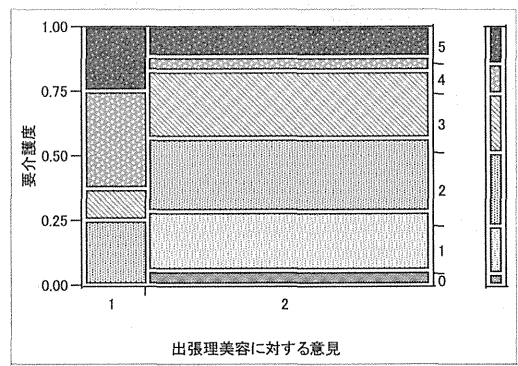

図1-45 施術場所に対する意見と要介護度の関係

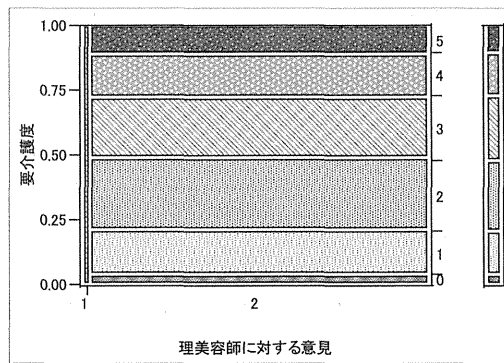

図2-1 体温\_前

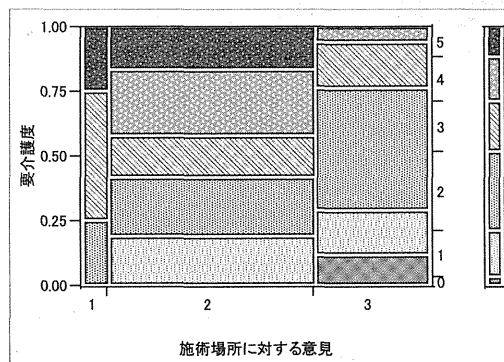

図2-2 体温\_後

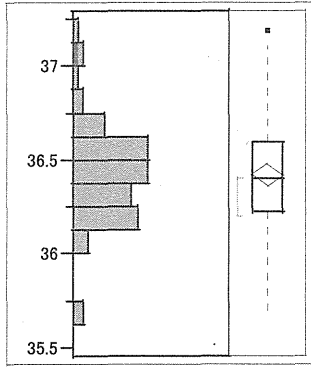

図2-3 体温\_差

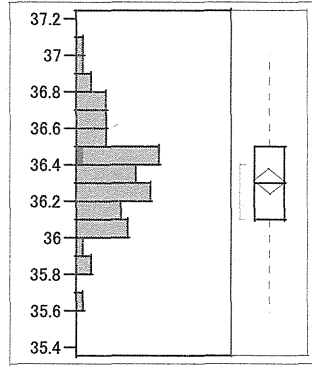

図2-4 体温\_前と体温\_後の二変量の関係

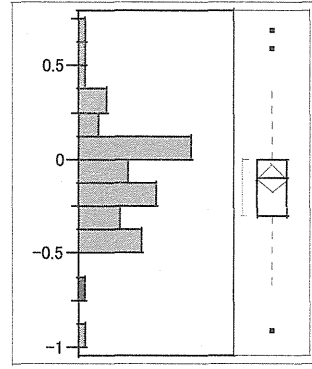

図2-5 脈拍\_前

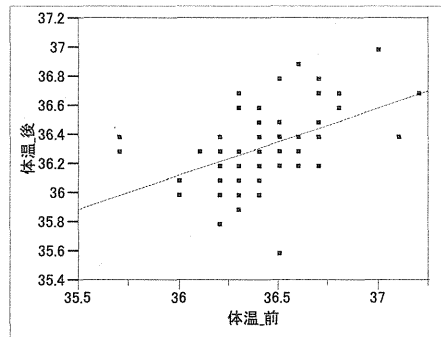

図2-6 脈拍\_後

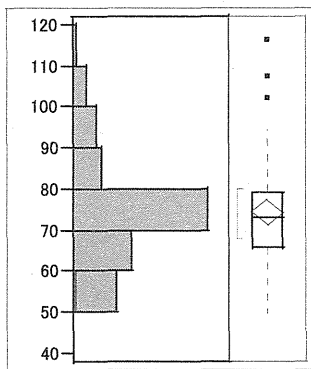

図2-7 脈拍\_差

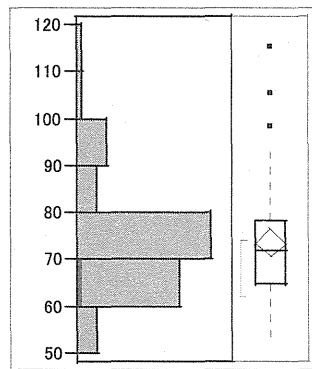

図2-8 脈拍\_前と脈拍\_後の二変量の関係



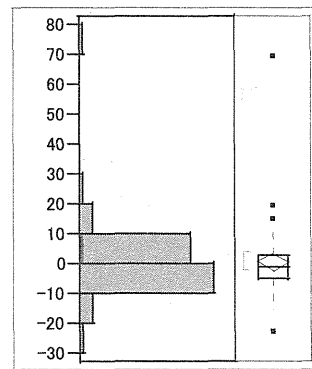

図2-9 血圧上\_前

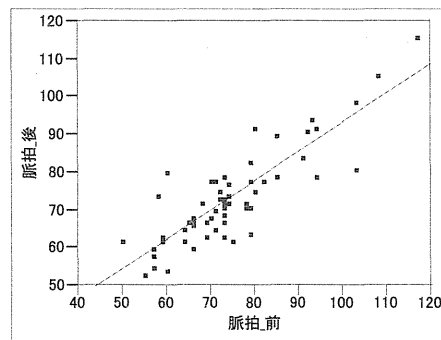

図2-10 血圧上\_前

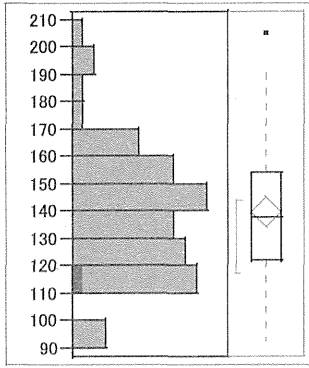

図2-11 血圧上\_差

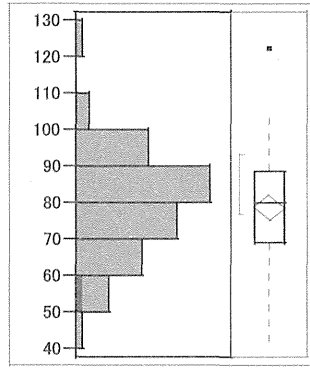

図2-12 血圧上\_前と血圧上\_後の二変量の関係

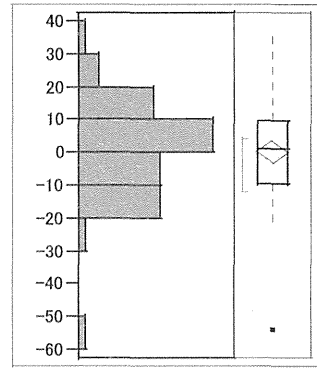

図2-13 血圧下\_前

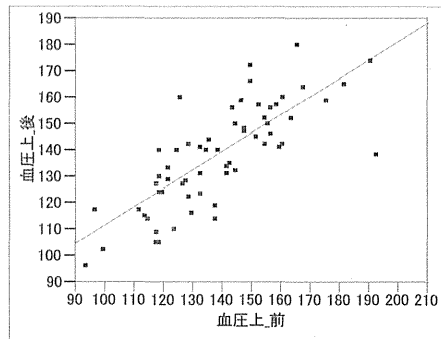

図2-14 血圧下\_後

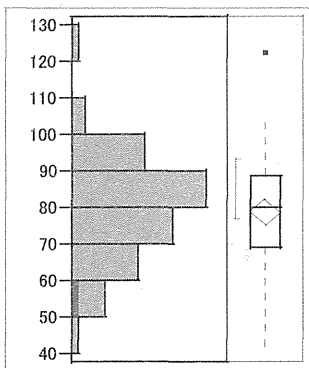

図2-15 血圧下\_差

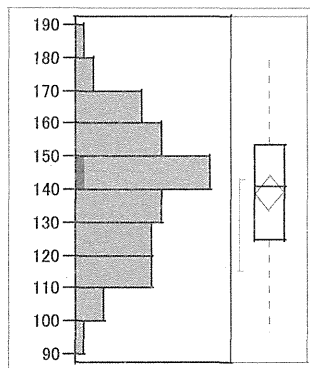

図2-16 血圧下\_前と血圧下\_後の二変量の関係

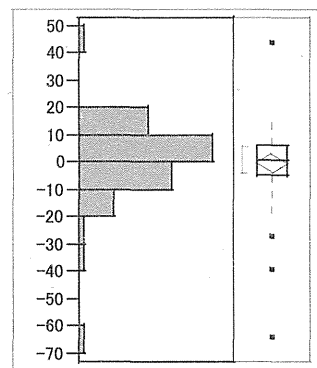

図2-17 アミラーゼ\_前

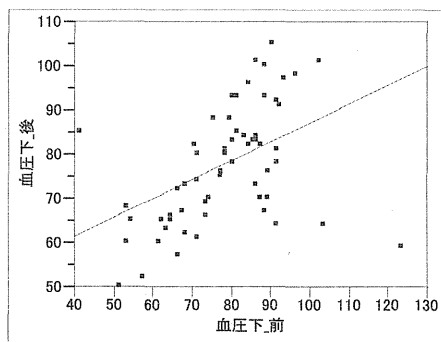

図2-18 アミラーゼ\_後

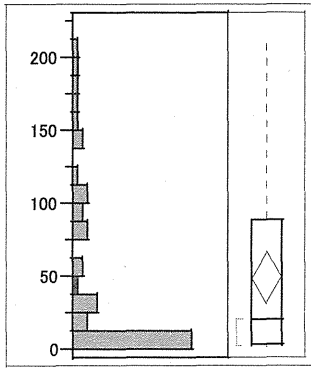

図2-19 アミラーゼ\_差

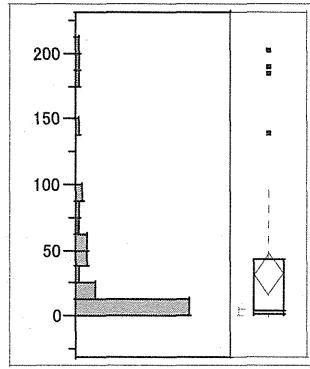

図2-20 アミラーゼ\_前とアミラーゼ\_後の二変量の関係

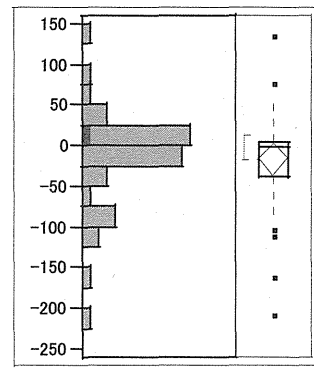

図2-21 施術前体温

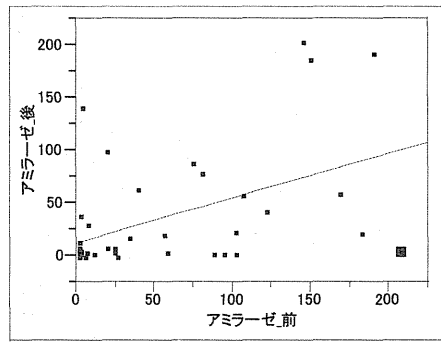

図2-22 施術後体温

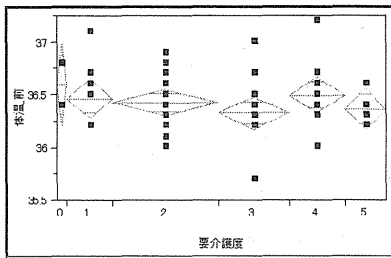

図2-23 施術前後の体温差

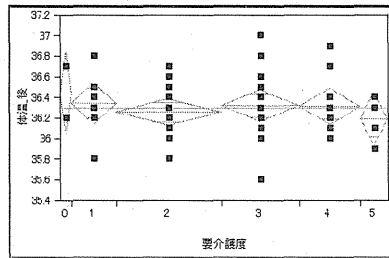

図2-24 施術前の脈拍

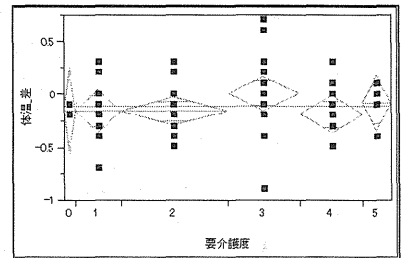

図2-25 施術後の脈拍

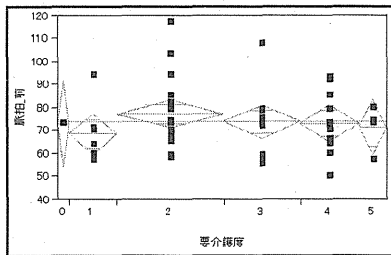

図2-26 施術前後の脈拍差

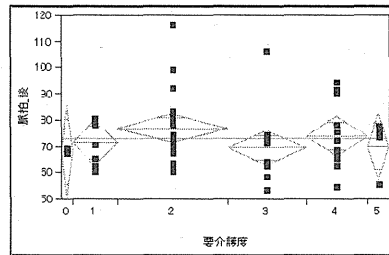

図2-27 施術前の血圧上

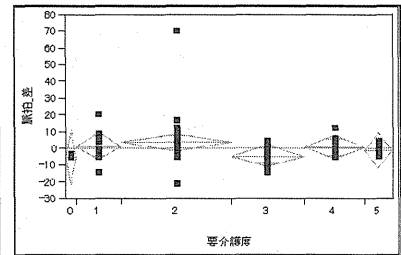

図2-28 施術後の血圧上

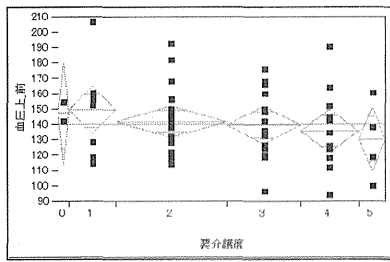

図2-29 施術前後の脈拍差

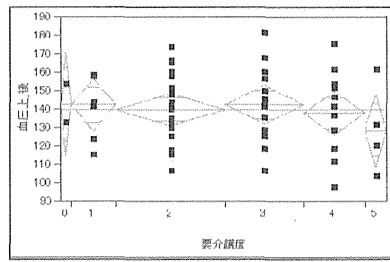

図2-30 施術前の血圧下

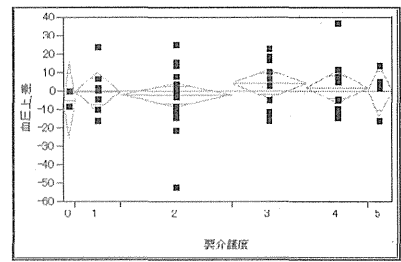

図2-31 施術後の血圧下

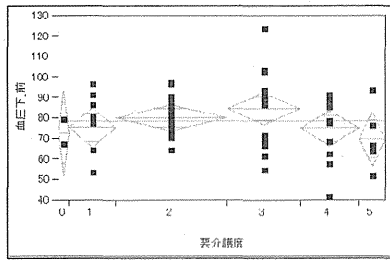

図2-32 施術前後の血圧下差

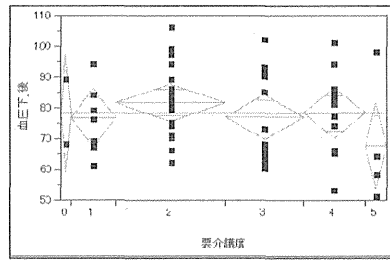

図2-33 施術前のアミラーゼ

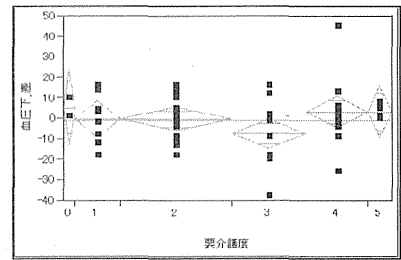

図2-34 施術後のアミラーゼ

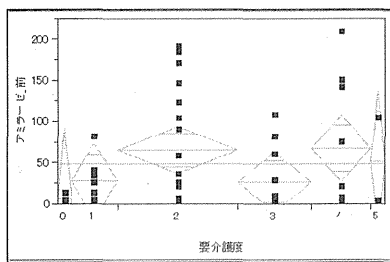

図2-35 施術前後のアミラーゼ差

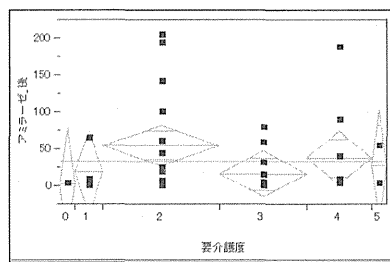

図2-36 施術前の体温

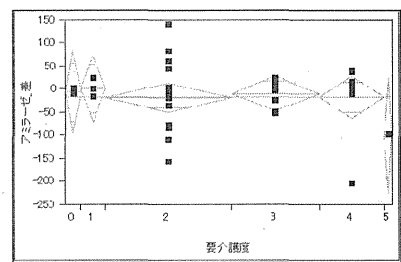

図2-37 施術後の体温

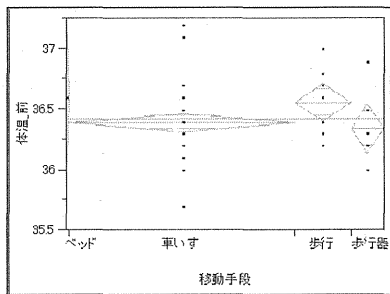

図2-38 施術前後の体温差

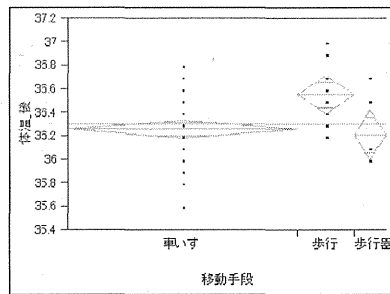

図2-39 施術前の脈拍

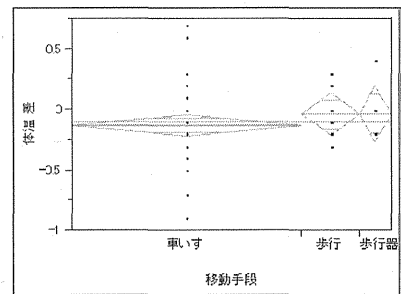

図2-40 施術後の脈拍

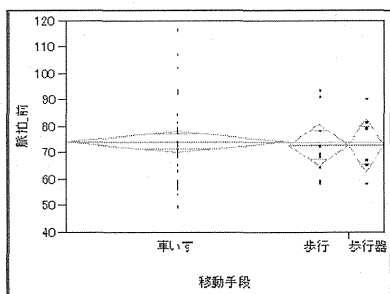

図2-41 施術前後の脈拍差

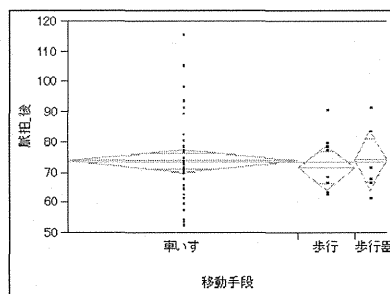

図2-42 施術前の血圧下

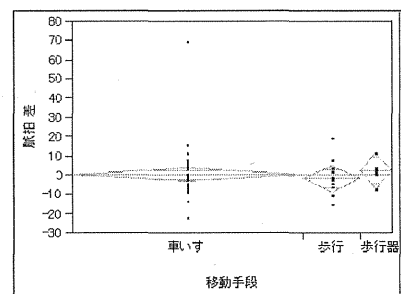

図2-43 施術後の血圧上

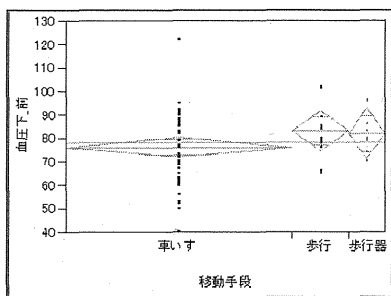

図2-44 施術前後の血圧上の差

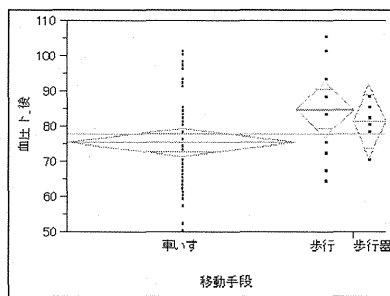

図2-45 施術前の血圧上

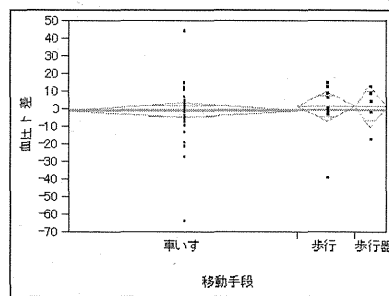

図2-46 施術後の血圧上

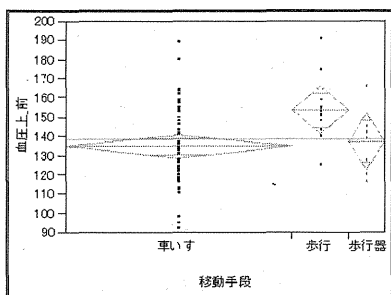

図2-47 施術前後の血圧上の差

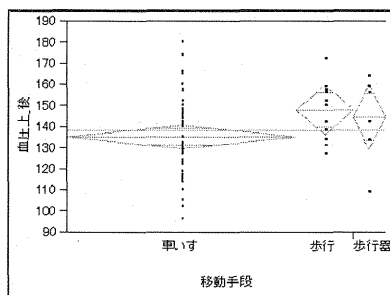

図2-48 施術前のアミラーゼ

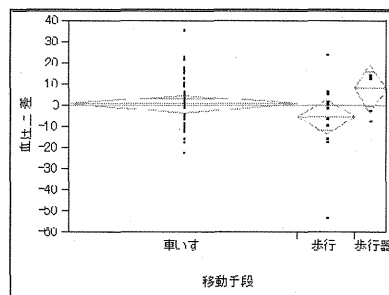

図2-49 施術後のアミラーゼ

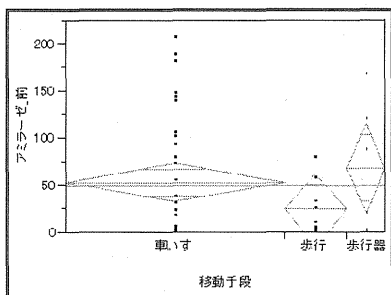

図2-50 施術前後のアミラーゼ差

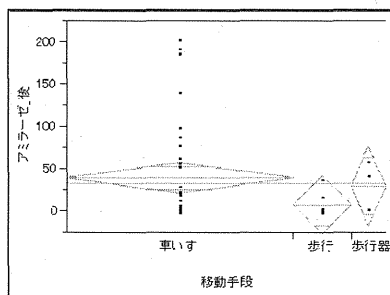

図2-51 施術前の体温

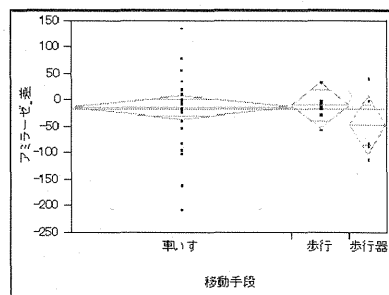

図2-52 施術後の体温

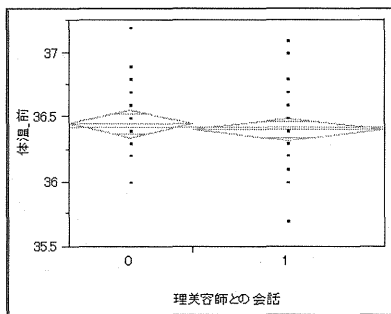

図2-53 施術前後の体温差

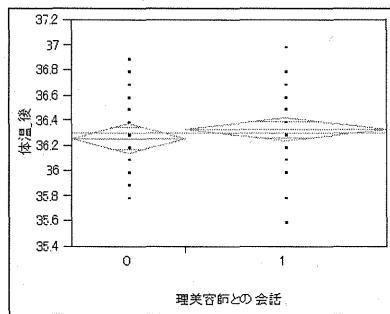

図2-54 施術前の脈拍

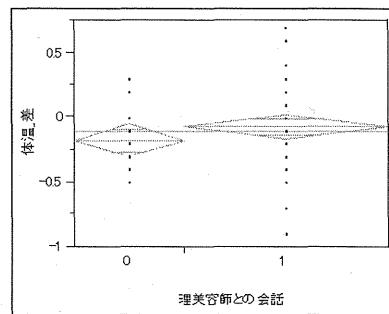

図2-55 施術後の脈拍

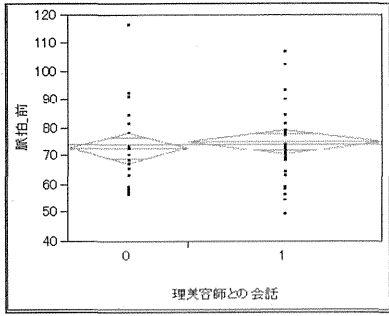

図2-56 施術前後の脈拍差

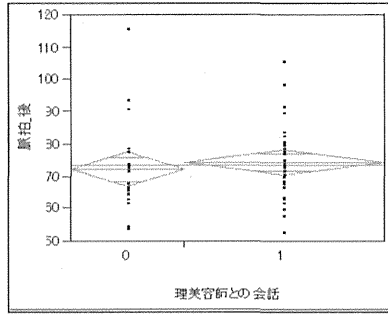

図2-57 施術前の血圧下

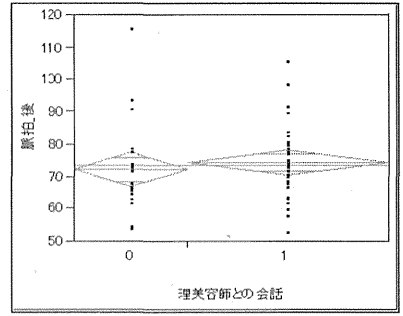

図2-58 施術後の減圧下

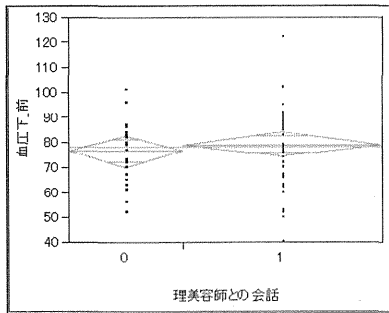

図2-59 施術前後の血圧下の差

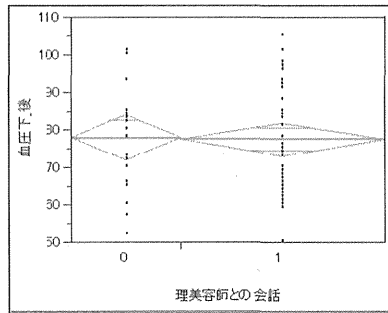

図2-60 施術前の血圧上

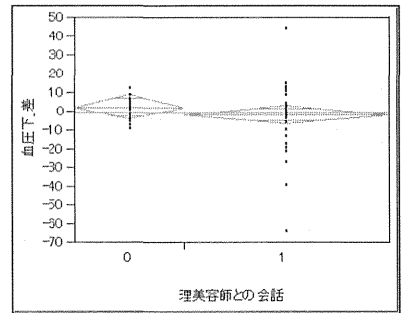

図2-61 施術後の血圧上

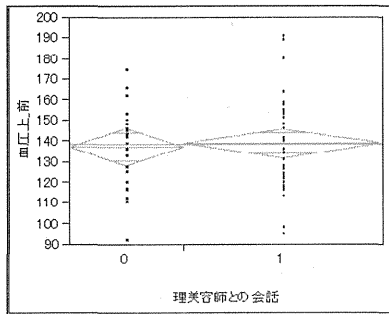

図2-62 施術前後の血圧上の差

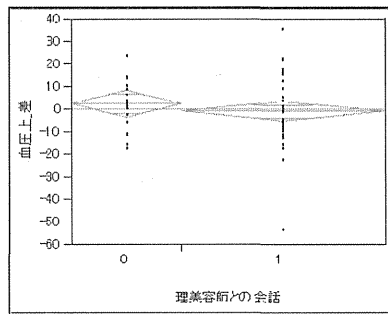

図2-63 施術前のアミラーゼ

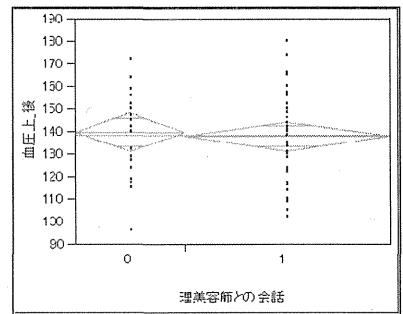

図2-64 施術後のアミラーゼ

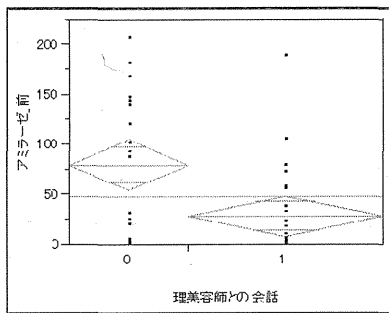

図2-65 施術前後のアミラーゼ差

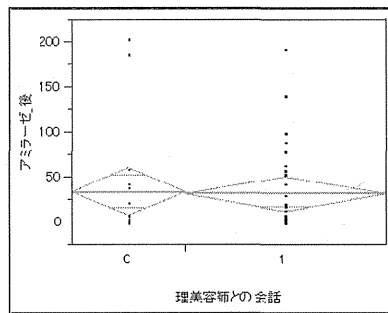

図2-66 施術前のアミラーゼ 図2-67 施術後のアミラーゼ 図2-68 施術前後のアミラーゼ差

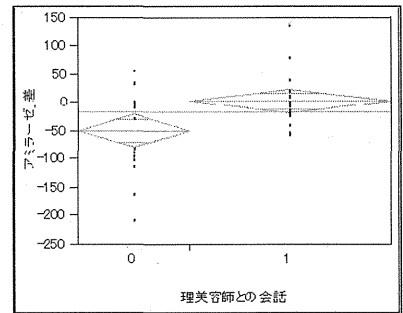

図2-69 施術後の血圧下 図2-70 施術前後の血圧下の差 図2-71 施術前後の体温差

施術前のアミラーゼ

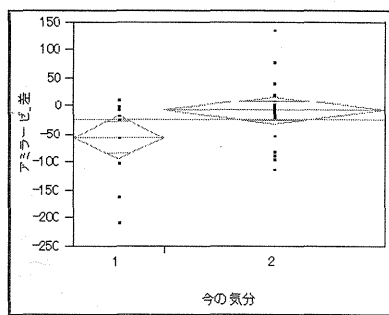
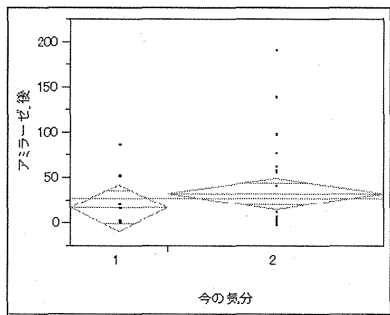
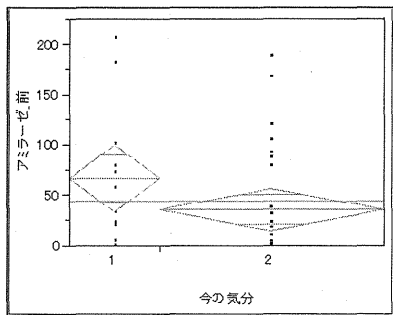

図2-72 施術前のアミラーゼ

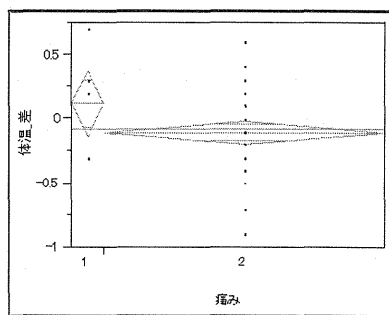
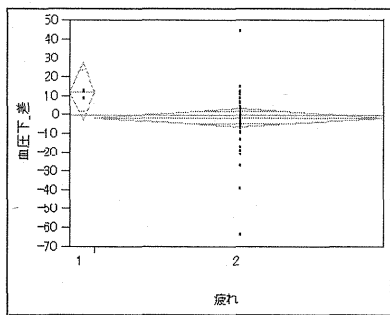
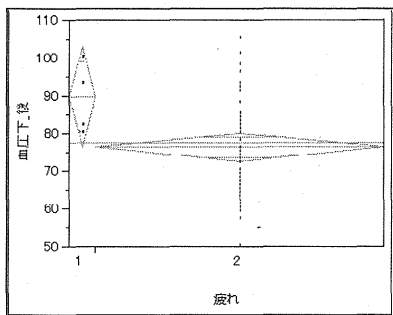
施術後のアミラーゼ



図2-73 施術後のアミラーゼ

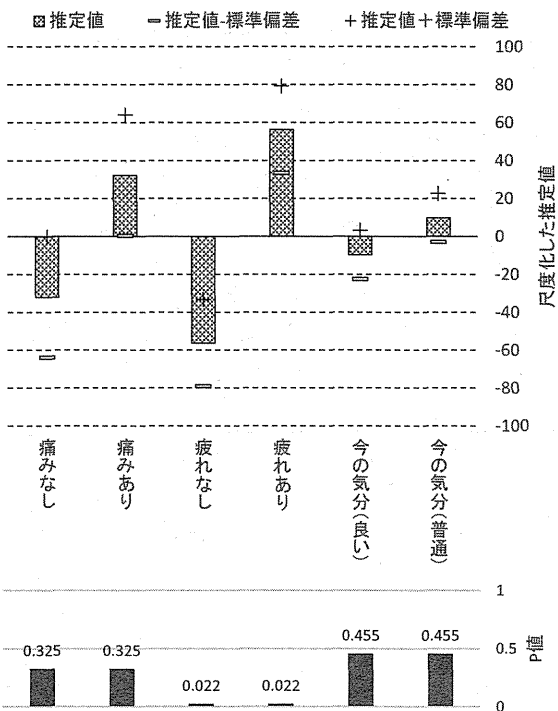

図2-74 施術前後のアミラーゼ差

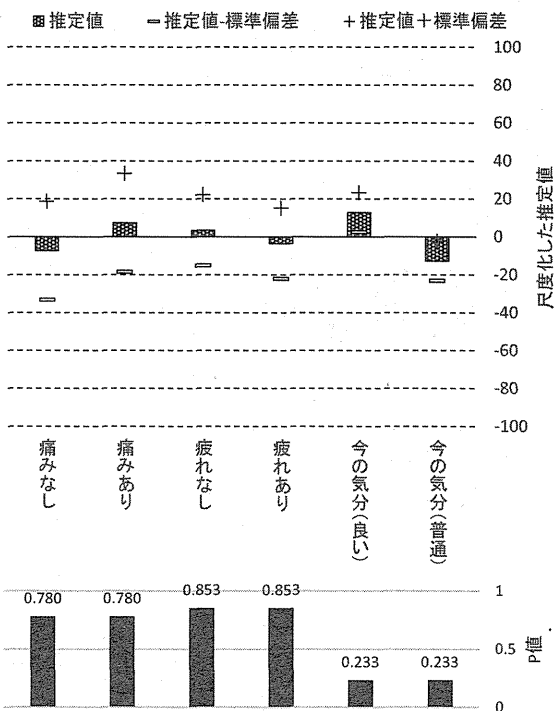

図 2-75 出張理美容に対する意見

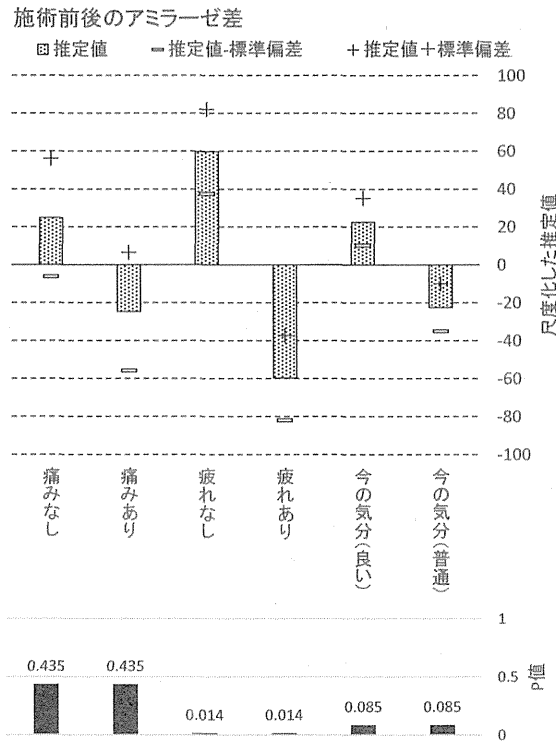

図 2-76 施術場所に対する意見

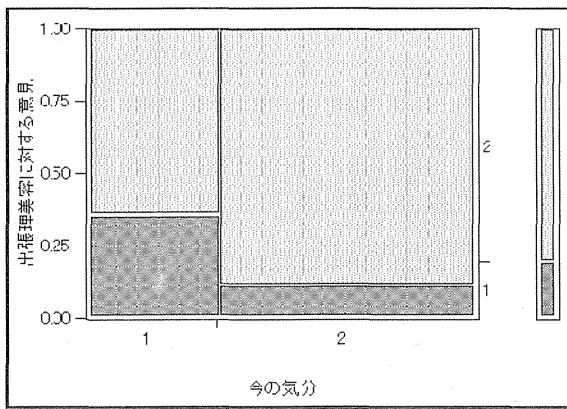

図 3-1 施術場所と体温<sub>後</sub> (p<0.05)

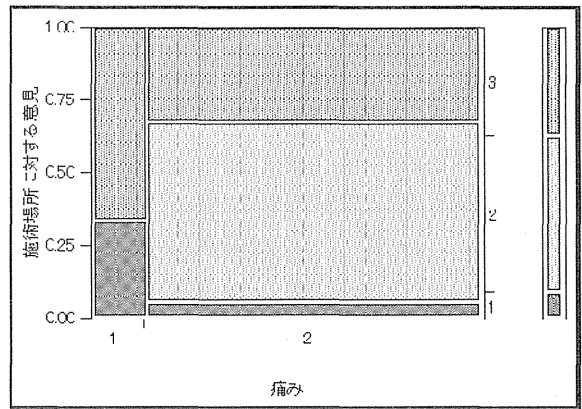

図 3-2 施術場所と体温<sub>差</sub> (p<0.05)

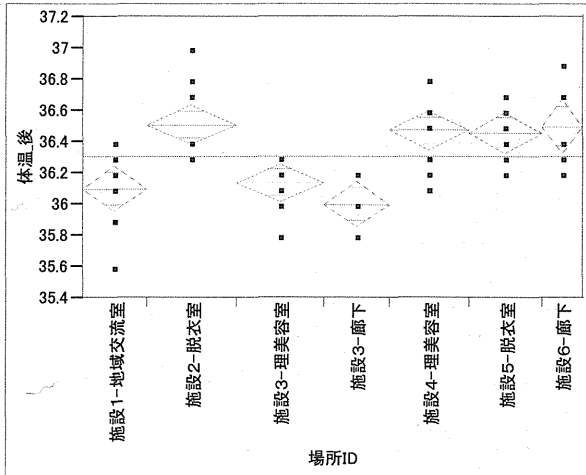

図 3-3 施術場所と今の気分

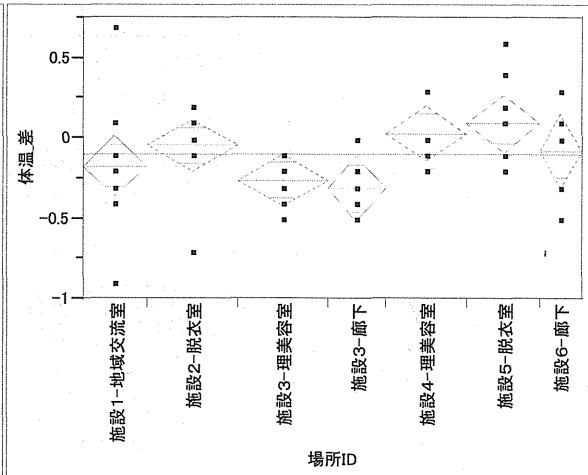

図 3-4 施術場所と疲れ

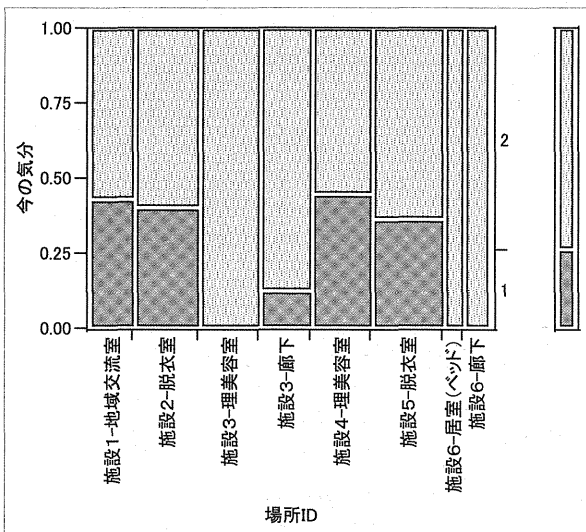

図 3-5 施術場所と痛み

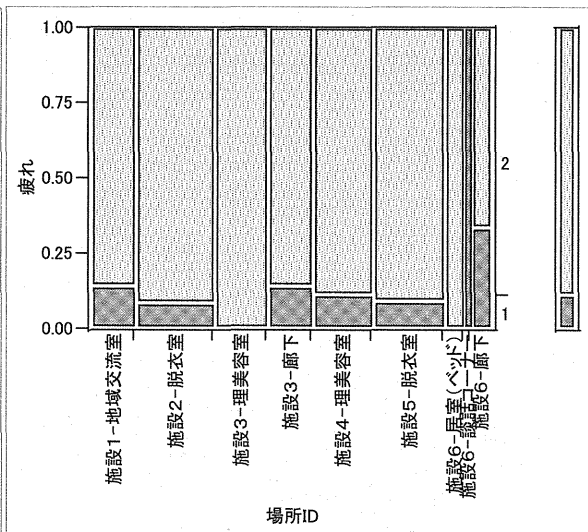

図 3-6 施術場所と出張理美容に対する意見



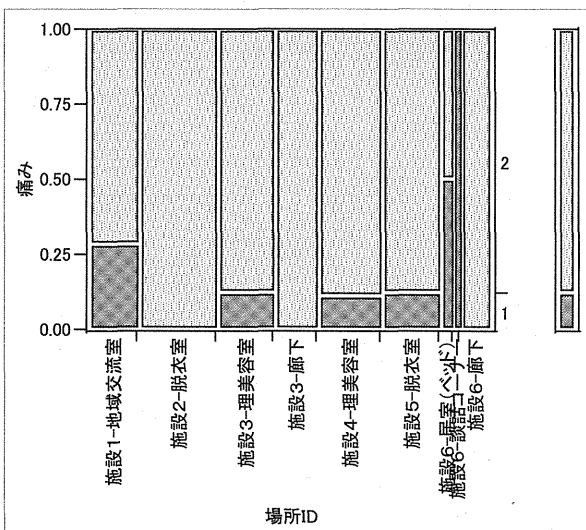

図 3-7 施術場所と施術場所に対する意見

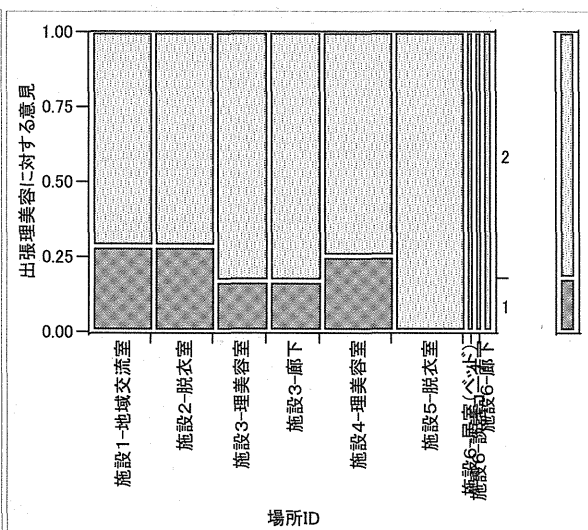

図 3-8 相対湿度と今の気分 ( $p < 0.05$ )

図 3-9 絶対湿度と今の気分 ( $p < 0.05$ )

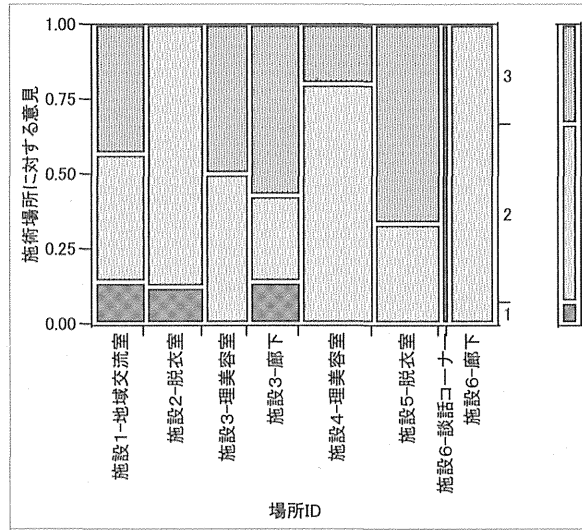

図 3-10 照度と施術場所に対する意見 ( $p < 0.1$ )

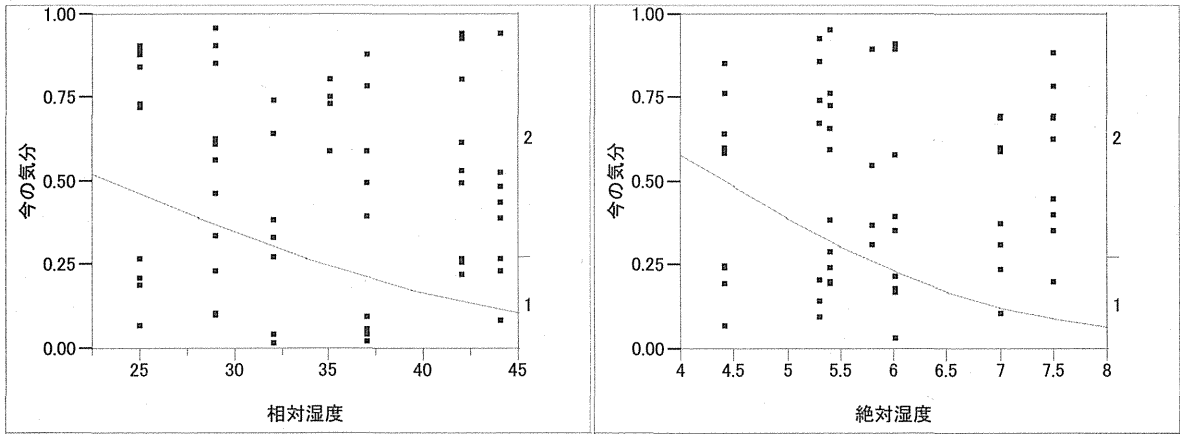

図 3-11 温度と体温\_後 (p<0.05)

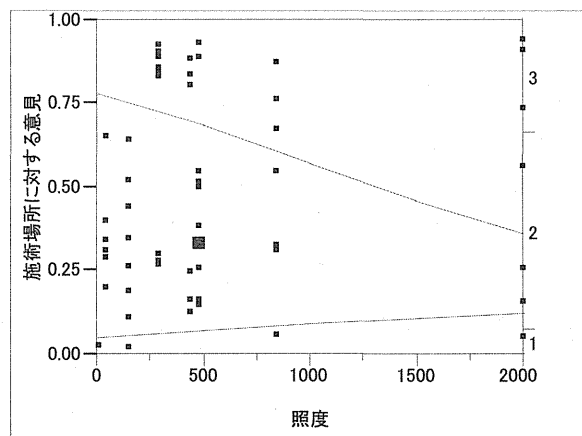

図 3-12 相对湿度と体温\_後 (p<0.001)

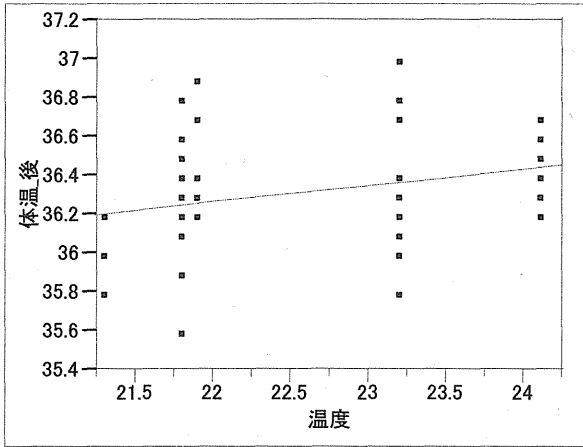

図 3-13 絶対湿度と体温\_後 (p<0.001)

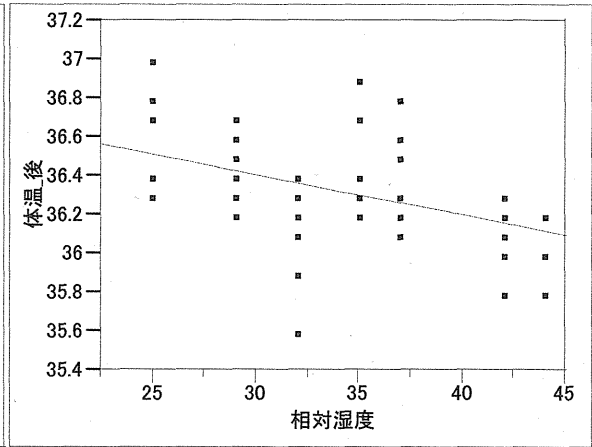

図 3-14 CO2 と体温\_後 (p<0.05)

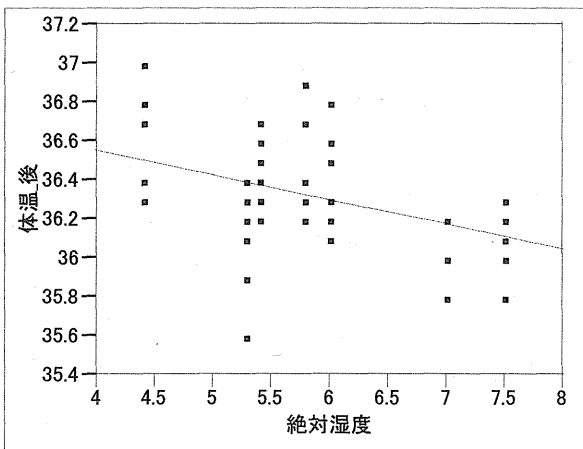

図 3-15 照度と体温\_後 (p<0.001)

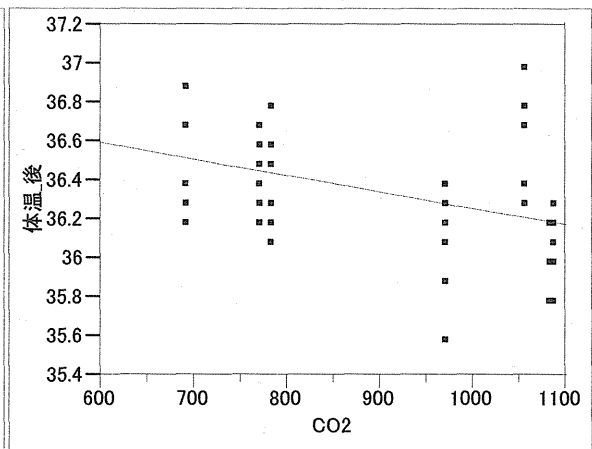

図 3-16 相对湿度と血压上\_差 (p<0.01)

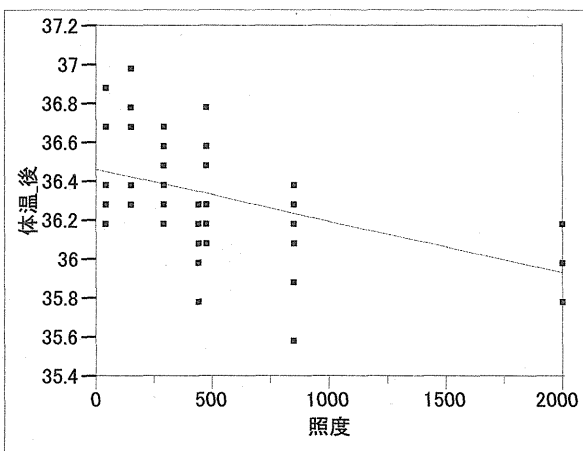

図 3-18 照度と血圧上\_差 ( $p < 0.1$ )

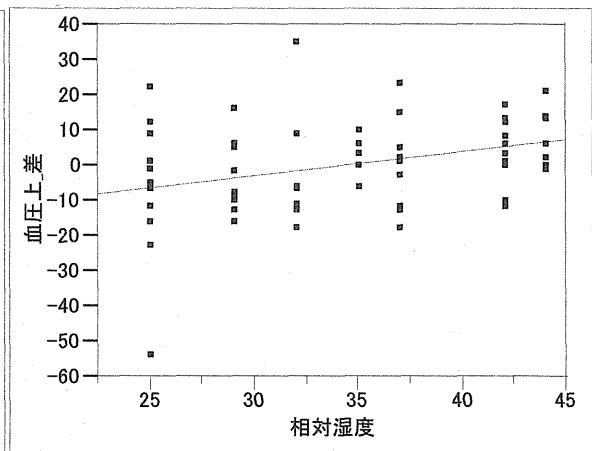

図 3-17 絶対湿度と血圧上\_差 ( $p < 0.03$ )

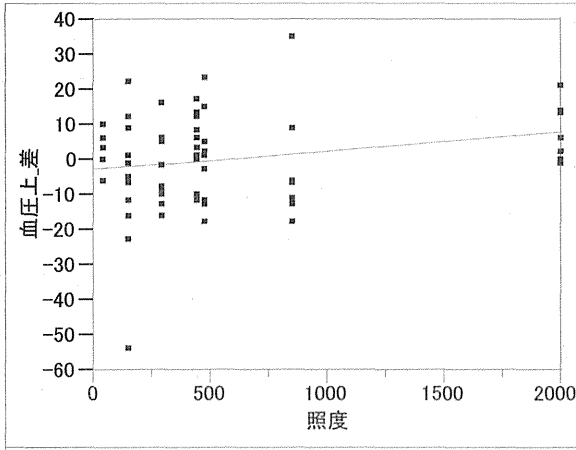

図 3-20 絶対湿度と血圧下\_差 ( $p < 0.1$ )

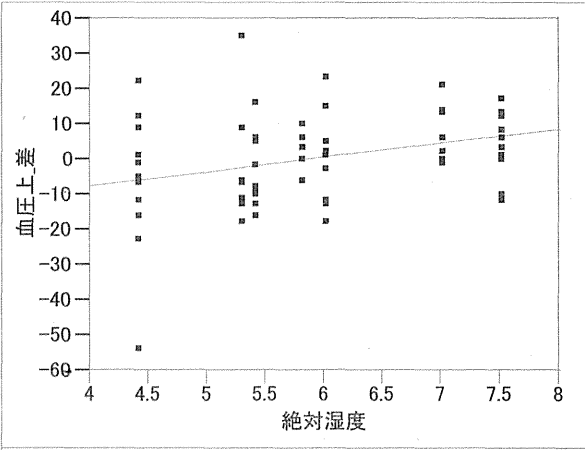

図 3-19 相対湿度と血圧下\_差 ( $p < 0.05$ )

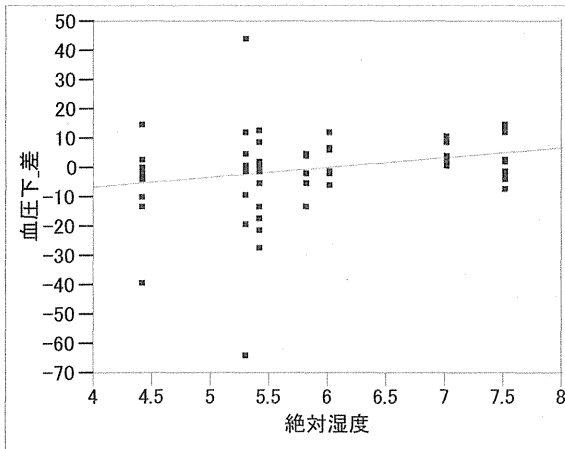

図 3-21 照度とアミラーゼ\_前 ( $p < 0.1$ )

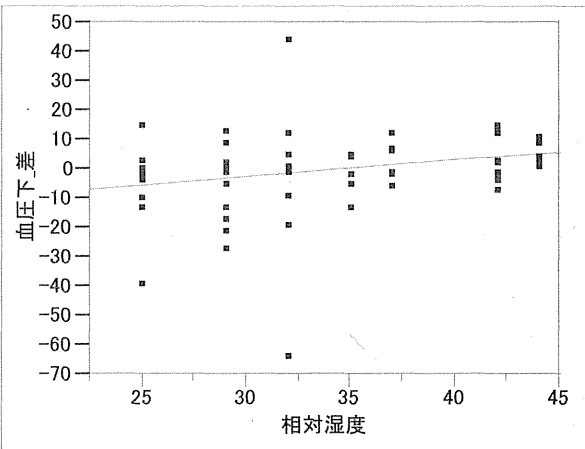

図 3-22 温度とアミラーゼ\_差 ( $p = 0.12$ )

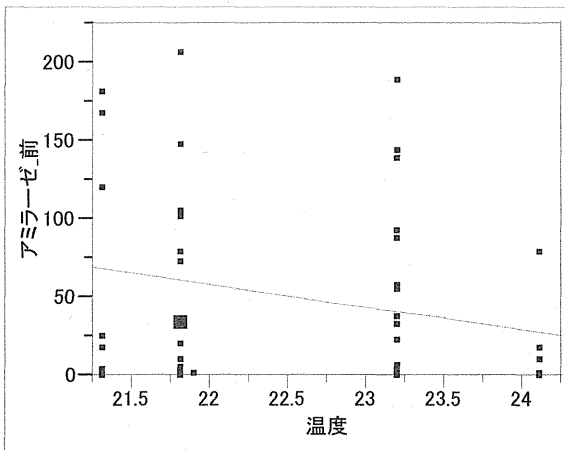

図 3-23 CO<sub>2</sub>とアミラーゼ\_前 (p<0.1)

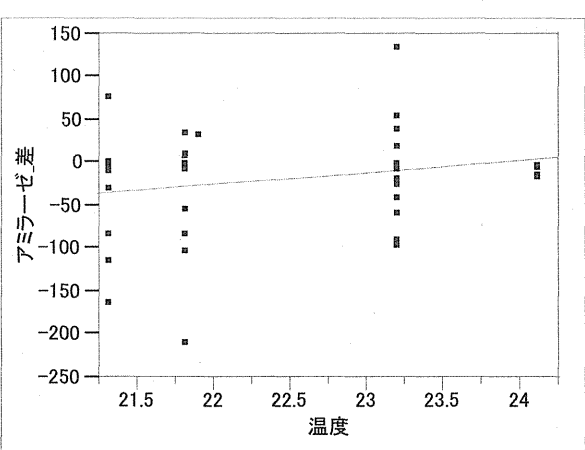
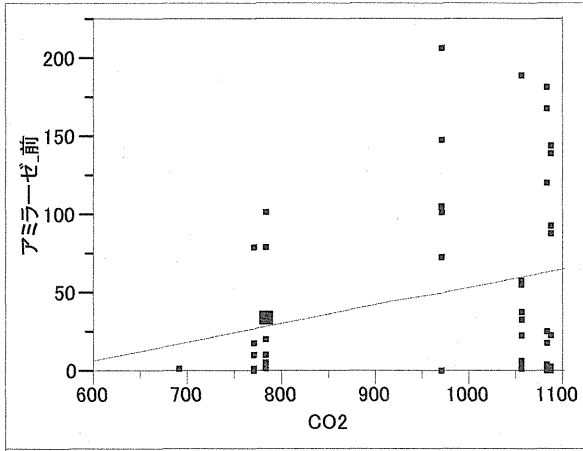
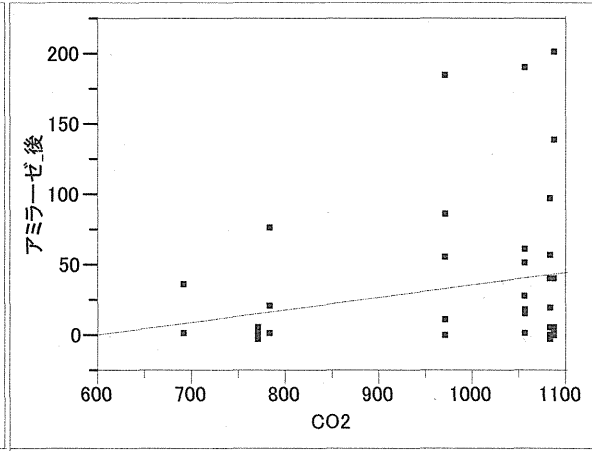

図 3-24 CO<sub>2</sub>とアミラーゼ\_後 (p=0.1)