

Methods

Participants

Patients with a cognitive disorder who were referred to the memory clinic of the Department of Geriatric Medicine in Kyoto University Hospital, Kyoto, Japan, were enrolled in the present study. All patients underwent brain MRI, as well as a battery of laboratory tests. The diagnosis of AD and mild cognitive impairment (MCI) was made according to the following criteria: AD, Diagnostic and Statistical Manual of Mental Disorders, 4th edition and National Institute of Neurological and Communicative Disorders and Stroke and the Alzheimer's Disease and Related Disorders Association;^{18,19} and MCI, Petersen's criteria.²⁰ In the present study, we did not set the upper limit of the Mini-Mental State Examination (MMSE) for the diagnosis of MCI. Of the 31 patients with a cognitive disorder, 20 were classified as mild AD and 11 were classified as MCI by the criteria. Those with MMSE scores below 19 were excluded from the present study.²¹ Other exclusion criteria used in the present study were vascular dementia, dementia with Lewy bodies, lacunar infarcts, Fazekas grade 3 periventricular hyperintensity (PVH)/deep white-matter hyperintensity (DWMH),²² severe cardiac, pulmonary or musculoskeletal disorders, and the presence of comorbidities associated with greater risk of falls, such as Parkinson's disease and stroke.

Written informed consent was obtained from each participant or his/her family members for the trial in accordance with the guidelines approved by the Kyoto University Graduate School of Medicine and the Declaration of Human Rights, Helsinki, 1975.

MRI

MRI scans were carried out with a 1.5-T superconductive MRI unit (Magnétom Symphony; Siemens Medical, Erlanger, Germany). Whole-brain volumetric imaging with 3-D gradient refocused echo sequence (magnetization prepared rapid gradient echo, or MPRAGE) was carried out for voxel-based morphometry analysis using the following parameters: field of view (FOV) 22 × 22 cm, matrix 256 × 256, 120 contiguous 1.25-mm thick sagittal slices, TR/TE/TI 1700/3.93/800 ms and FA 15°.

Voxel-based morphometry

The voxel-based analysis system in the present study has been validated.²³ Currently, their software is distributed in Japan under the name, Voxel-Based Specific Regional Analysis System for Alzheimer's Disease (VSRAD). VSRAD automatically calculated the following analysis results, which reflect the severity of gray

matter loss in the global brain by comparing the original normal database template. The severity of global brain gray matter loss was estimated with the Global Brain Atrophy Index, which was calculated as a percentage rate of voxels with a Z-score >2 compared with the whole brain.

Fall experience

Fall events in the past 1 year were recorded based on an interview with the family members. A fall was defined as "an event that results in a person coming to rest inadvertently on the ground or other lower level regardless of whether an injury was sustained, and not as a result of a major intrinsic event or overwhelming hazard".⁵ The date, number, characteristics (e.g. while rising from a lying or sitting position, while turning in the opposite direction, while tripping over an obstacle) and consequences (e.g. bruise, fracture) of the falls were recorded using a standardized questionnaire.

Cognitive function measures

Cognitive functions were assessed by MMSE, Clock Drawing Test (CDT), Trail Making Test part A (TMT-A), Verbal Fluency Test (animal) and Verbal Fluency Test with letter (ka). MMSE is a short screening test to assess cognitive impairment, which consists of five areas: orientation, registration, attention and calculation, and recall language. The CDT is a sensitive test for executive function and early cognitive impairment. The participant was asked to draw a clock with all the numbers on it and to set the time to 10 min past 11. We used a 10-point scoring system by Rouleau *et al.*²⁴ The TMT-A assesses working memory capacity. Patients need to connect the numbers in order, beginning with 1 and ending with 25, as fast as possible. Word fluency is a sensitive test to detect early changes in cognitive function. In the Verbal Fluency Task (animal), patients were instructed to name as many animals as possible within 1 min. In the Verbal Fluency Task, the subject was asked to say as many words as possible beginning with the letters "ka" in 1 min.²⁵

Physical performance measures

The participants were subjected to five physical function tests that are widely used to identify frail elderly. For each performance task, the participants performed two trials, and the better performance of two trials was used as scores in the analysis. The physical performance assessment, such as 10-m walking time,²⁶ Timed Up & Go (TUG) Test,²⁷ Functional Reach (FR),²⁸ One-Leg Stand (OLS) test²⁹ and Five Chair Stands (5CS) Test,³⁰ was carried out as previously described.

Physical activity measures

In physical activity, a valid, accurate and reliable pedometer, Yamax Power walker EX-510 (Yamasa, Tokyo, Japan) was used to measure free-living step counts.³¹ Participants were instructed to wear the pedometer in their pocket on the side of the dominant leg for 14 consecutive days except when bathing, sleeping and carrying out water-based activities. This pedometer has a 30-day data storage capacity. We calculated the averages of their daily step counts for 2 weeks.

Statistical analysis

The *t*-test and χ^2 -test were used to compare the results of measurements between faller and non-faller groups. The relationship between the global brain atrophy and the other measurements was investigated with the Spearman's correlation coefficient. The partial correlation coefficient between the global brain atrophy and the other measurements were adjusted for age. Multivariate logistic regression analysis using a stepwise method was carried out to investigate whether age, sex, body mass index (BMI), Global Brain Atrophy Index, word fluency animals, CDT, maximum walking time and TUG were independently associated with the fall

incident. Data were analyzed using the Statistical Package for Social Science, Windows version 20.0 (SPSS, Chicago, IL, USA).

Results

There were no significant differences in age (fallers 78.2 ± 7.1 years, non-fallers 77.7 ± 5.4 years, $P = 0.53$), percentage of female (fallers 80.0%, non-fallers 71.4%, $P = 0.48$), height (fallers 150.7 ± 11.9 cm, non-fallers 153.2 ± 7.9 cm, $P = 0.37$), weight (fallers 52.9 ± 12.4 kg, non-fallers 50.5 ± 7.8 kg, $P = 0.74$) or BMI (fallers 23.2 ± 3.7 , non-fallers 21.5 ± 2.8 , $P = 0.39$) between the two groups (Table 1).

The fallers had significantly worse scores than the non-fallers in the Global Brain Atrophy Index (fallers 13.9 ± 8.3 , non-fallers 6.8 ± 3.8 , $P = 0.01$), CDT (fallers 8.2 ± 1.1 , non-fallers 9.3 ± 0.8 , $P = 0.01$), Verbal Fluency Test (animal; fallers 6.2 ± 2.7 , non-fallers 9.5 ± 3.9 , $P = 0.02$), maximum walking time (fallers 10.4 ± 4.4 , non-fallers 7.5 ± 1.7 , effect size 0.64, $P = 0.03$) and TUG (fallers 13.5 ± 7.0 , non-fallers 8.9 ± 1.9 , $P = 0.01$). However, the other measurements were not significantly different between the two groups ($P > 0.05$; Table 1, Fig. 1).

Table 1 Comparison of demographic characteristics and measurements between the groups

Characteristics	Faller <i>n</i> = 10		Non-faller <i>n</i> = 21		E/S	<i>P</i> -value
	Mean	SD	Mean	SD		
Characteristics						
Age	78.2	7.1	77.7	5.4	0.08	0.53
BMI	23.2	3.7	21.5	2.8	0.45	0.39
Sex (female), <i>n</i> (%)	8 (80.0%)		15 (71.4%)			0.48
Disease (MCI), <i>n</i> (%)	5 (50.0%)		6 (28.5%)			0.32
Brain volume						
Global brain atrophy, %	13.9	8.3	6.8	3.8	0.86	0.01
Cognitive function						
Mini-Mental State Examination, points	24.7	3.8	23.7	2.5	0.27	0.59
Word Fluency Test (animals), number	6.2	2.7	9.5	3.9	0.84	0.02
Letter Fluency Test (ka), number	6.0	2.4	6.0	2.6	0.00	0.88
Clock Drawing Test, points	8.2	1.1	9.3	0.8	0.92	0.01
Trail Making Test Part-A, sec	78.7	43.2	72.3	16.1	0.15	0.53
Physical function						
Comfortable walking time, sec	12.1	4.0	10.1	2.5	0.53	0.07
Maximum walking time, sec	10.4	4.4	7.5	1.7	0.64	0.03
Timed Up & Go Test, sec	13.5	7.0	8.9	1.9	0.65	0.01
Functional Reach, cm	18.8	8.5	22.2	6.4	0.41	0.36
One-Leg Standing time, sec	6.5	11.3	16.7	18.8	0.91	0.06
Five Chair Stands, sec	11.9	2.8	10.5	3.2	0.48	0.18
Activity						
Physical activity, steps	3167.9	2213.1	4499.8	2934.4	0.45	0.21

MCI, mild cognitive impairment.

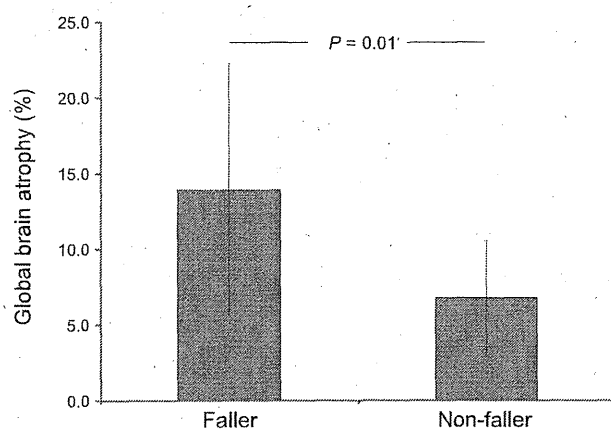

Figure 1 Comparison of Global Brain Atrophy Index (%) between the groups. The fallers ($n = 10$) had significantly worse scores than the non-fallers ($n = 21$) in the Global Brain Atrophy Index.

To determine the association of global brain atrophy with their demography, cognitive function, physical performance and physical activity, we determined Pearson's correlation coefficients. Table 2 shows that the Global Grain Atrophy Index was correlated with age ($r = 0.435$, $P < 0.05$), Verbal Fluency Test (animal; $r = -0.641$, $P < 0.05$), Verbal Fluency Test with letter (ka; $r = -0.320$, $P < 0.05$), CDT ($r = -0.338$, $P < 0.05$), comfortable walking time ($r = 0.555$, $P < 0.05$), maximum walking time ($r = 0.543$, $P < 0.05$), TUG ($r = 0.630$, $P < 0.05$), OLS ($r = -0.581$, $P < 0.05$), 5CS ($r = 0.437$, $P < 0.05$) and physical activity ($r = -0.389$, $P < 0.05$; Table 2).

To age-adjust the association of Global Brain Atrophy Index with their demography, cognitive function, physical performance and physical activity, we analyzed partial correlation coefficients. Table 2 shows that global brain atrophy was correlated with BMI ($r = 0.308$), Verbal Fluency Test (animal; $r = -0.522$, $P < 0.05$), Verbal Fluency Test with letter (ka; $r = -0.337$, $P < 0.05$), CDT ($r = -0.547$, $P < 0.05$), TUG ($r = 0.276$, $P < 0.05$) and 5CS ($r = 0.303$, $P < 0.05$; Table 2).

Stepwise regression analysis showed that the Global Brain Atrophy Index ($\beta = 1.265$, 95% CI 1.022–1.567) was a significant and independent determinant of falls ($R^2 = 0.356$, $P = 0.003$; Table 3).

Discussions

The present study showed that the fall incident might relate to global brain atrophy in older adults with mild cognitive disorders. The fallers also showed a significantly higher Global Brain Atrophy Index, and lower physical and cognitive performance scores than the non-fallers. Age-adjusted correlation analyses showed

Table 2 Correlation coefficients for global brain atrophy and other measurements

	Global brain atrophy	Global brain atrophy (adjusted for age)
Characteristics		
Age	0.435	
Cognitive function		
Mini-Mental State Examination	0.019	-0.147
Word Fluency Test (animals)	-0.641	-0.522
Letter fluency Test (ka)	-0.320	-0.337
Clock Drawing Test	-0.338	-0.547
Trail Making Test Part-A	0.067	0.053
Geriatric Depression Scale	0.210	0.181
Physical function		
Comfortable walking time	0.555	0.205
Maximum walking time	0.543	0.221
Timed Up & Go Test	0.630	0.276
Functional reach	-0.121	-0.009
One-Leg Standing time	-0.581	-0.204
Five Chair Stands	0.473	0.303
Activity		
Physical activity	-0.389	-0.169

Table 3 Logistic regression analysis

Independent variables	Adjusted R^2 value = 0.356	
	Standard regression value	95% CI
Age	-	-
Sex	-	-
BMI	-	-
Brain atrophy index	1.265	1.022–1.567
Word Fluency (animals)	-	-
Clock Drawing Test	-	-
Maximum walking time	-	-
Timed Up & Go Test	-	-

BMI, body mass index.

that the Global Brain Atrophy Index was weakly correlated with several cognitive and motor performances. Furthermore, stepwise regression analysis showed that the Global Brain Atrophy Index was a significant

and independent determinant of the fall incident. Taken together, these findings led us to conclude that measuring global brain atrophy is potentially important to predict falls in patients with mild cognitive disorders.

The mechanisms by which global brain atrophy associates with fall incident and poor physical performance are not well understood. It is possible that global brain atrophy is related to poor neural connectivity. However, we assume that global brain atrophy is mostly attributed to the volume loss in the frontal lobe, because Rosano *et al.* suggested that a smaller prefrontal region was associated with slower gait speed.³² In contrast, it has been shown that atrophy of dorsolateral prefrontal regions is associated with poorer executive function.³³ Previous imaging research has also shown that brain atrophy is associated with impaired physical and executive functions.^{17,34} As expected, physical and executive functions have been associated with an increased fall risk in older adults.^{35,36} These reports and the present study suggested that the function of the frontal lobe is associated with the risk of falls, and brain atrophy index can be a biomarker to predict falls.

There are several limitations in the present study. First, the limited sample size might introduce some error of inference, reduce the power of the analysis and limit generalization. Second, global brain atrophy might not be able to predict falls in more robust older adults, as the present study was based on the participants having experienced falls in the previous year. Further study is required to confirm our finding in patients who do not have an experience of falls. Finally, detailed information on falls was lacking. Therefore, the relationship between the decline of frontal lobe function and fall incidents requires further investigation. Thus, the results of the present study should be interpreted with caution.

In conclusion, this is the first study to show that global brain atrophy is associated with fall incident, motor and cognitive performance in older adults with mild cognitive disorders. From the present results, global atrophy might be indicted as one of risk factors for falls in older adults with mild cognitive disorders. Further investigation, such as a prospective study, is required to confirm the present study.

Acknowledgments

This work was supported by the Grants-in-aid for Scientific Research from the Japan Society for the Promotion of Science, from the Ministry of Education, Culture, Sports, Science, and Technology.

Disclosure statement

None of the authors have conflicts of interest or financial disclosures.

References

- 1 Tinetti ME, Inouye SK, Gill TM, Doucette JT. Shared risk factors for falls, incontinence, and functional dependence. Unifying the approach to geriatric syndromes. *JAMA* 1995; **273**: 1348–1353.
- 2 Tinetti ME, Williams CS. Falls, injuries due to falls, and the risk of admission to a nursing home. *N Engl J Med* 1997; **337**: 1279–1284.
- 3 O'Loughlin JL, Robitaille Y, Boivin JF, Suissa S. Incidence of and risk factors for falls and injurious falls among the community-dwelling elderly. *Am J Epidemiol* 1993; **137**: 342–354.
- 4 Blake AJ, Morgan K, Bendall MJ *et al.* Falls by elderly people at home: prevalence and associated factors. *Age Ageing* 1998; **17**: 365–372.
- 5 Tinetti ME, Speechley M, Ginter SF. Risk factors for falls among elderly persons living in the community. *N Engl J Med* 1998; **319**: 1701–1707.
- 6 Allan LM, Ballard CG, Rowan EN, Kenny RA. Incidence and prediction of falls in dementia: a prospective study in older people. *PLoS ONE* 2009; **4**: e5521.
- 7 Aggarwal NT, Wilson RS, Beck TL, Bienias JL, Bennett DA. Motor dysfunction in mild cognitive impairment and the risk of incident Alzheimer disease. *Arch Neurol* 2006; **63**: 1763–1769.
- 8 Wylie SA, Ridderinkhof KR, Eckerle MK, Manning CA. Inefficient response inhibition in individuals with mild cognitive impairment. *Neuropsychologia* 2007; **45**: 1408–1419.
- 9 Longstreth WT, Manolio T, Arnold A *et al.* Cardiovascular Health Study. Clinical correlates of white matter findings on cranial magnetic resonance imaging of 3301 elderly people. *Stroke* 1996; **27**: 1274–1282.
- 10 Schmidt R, Fazekas F, Kleinert G *et al.* Magnetic resonance imaging signal hyperintensities in the deep and subcortical white matter: a comparative study between stroke patients and normal volunteers. *Arch Neurol* 1992; **49**: 825–827.
- 11 Starr JM, Leaper SA, Murray AD *et al.* Brain white matter lesions detected by magnetic resonance imaging are associated with balance and gait speed. *J Neurol Neurosurg Psychiatry* 2003; **74**: 94–98.
- 12 vanZagten M, Lodder J, Kessels F. Gait disorder and parkinsonian signs in patients with stroke related to small deep infarcts and white matter lesions. *Mov Disord* 1998; **13**: 89–95.
- 13 Söderlund H, Nilsson LG, Berger K *et al.* Cerebral changes on MRI and cognitive function: the CASCADE study. *Neurobiol Aging* 2006; **27**: 6–23.
- 14 Masdeu JC, Wolfson L, Lantos G *et al.* Brain white-matter changes in the elderly prone to falling. *Arch Neurol* 1989; **46**: 1292–1296.
- 15 Horikawa E, Matsui T, Arai H, Seki T, Iwasaki K, Sasaki H. Risk of falls in Alzheimer's disease: a prospective study. *Intern Med* 2005; **44**: 717–721.
- 16 Corti MC, Baggio G, Sartori L *et al.* White matter lesions and the risk of incident hip fracture in older persons: results from the progettovenetoanzianistudy. *Arch Intern Med* 2007; **167**: 1745–1751.
- 17 Raz N, Gunning-Dixon FM, Head D, Dupuis JH, Acker JD. Neuroanatomical correlates of cognitive aging: evidence from structural magnetic resonance imaging. *Neuropsychology* 1998; **12**: 95–114.
- 18 American Psychiatric Association. *Diagnostic and Statistical Manual of Mental Disorders*, 4th edn. Washington, DC: American Psychiatric Association, 1994.

- 19 McKhann G, Drachman D, Folstein M, Katzman R, Price D, Stadlan EM. Clinical diagnosis of Alzheimer's disease: report of the NINCDS-ADRDA Work Group under the auspices of Department of Health and Human Services Task Force on Alzheimer's Disease. *Neurology* 1984; **34**: 939-944.
- 20 Petersen RC, Smith GE, Waring SC, Ivnik RJ, Tangalos EG, Kokmen E. Mild cognitive impairment: clinical characterization and outcome. *Arch Neurol* 1999; **56**: 303-308.
- 21 Folstein MF, Folstein SE, McHugh PR. "Minimal state". A practical method for grading the cognitive state of patients for the clinician. *J Psychiatr Res* 1975; **12**: 189-198.
- 22 Fazekas F, Chawluk JB, Alavi A, Hurtig HI, Zimmerman RA. MR signal abnormalities at 1.5 T in Alzheimer's dementia and normal aging. *Am J Roentgenol* 1987; **149**: 351-356.
- 23 Hirata Y, Matsuda H, Nemoto K *et al.* Voxel-based morphometry to discriminate early Alzheimer's disease from controls. *Neurosci Lett* 2005; **382**: 269-274.
- 24 Rouleau I, Salmon DP, Butters N, Kennedy C, McGuire K. Quantitative and qualitative analyses of clock drawings in Alzheimer's and Huntington's disease. *Brain Cogn* 1992; **18**: 70-87.
- 25 Funabiki Y, Takechi H, Akamatsu T, Kita T. Development of a short neuropsychological battery to screen early dementia in elderly. *Geriatr Gerontol Int* 2002; **2**: 179-186.
- 26 Lopopolo RB, Greco M, Sullivan D, Craik RL, Mangione KK. Effect of therapeutic exercise on gait speed in community-dwelling elderly people: a meta-analysis. *Phys Ther* 2006; **86**: 520-540.
- 27 Podsiadlo D, Richardson S. The timed "Up & Go": a test of basic functional mobility for frail elderly persons. *J Am Geriatr Soc* 1991; **39**: 142-148.
- 28 Duncan PW, Weiner DK, Chandler J, Studenski S. Functional reach: a new clinical measure of balance. *J Gerontol* 1990; **45**: M192-M197.
- 29 Vellas BJ, Wayne SJ, Romero L, Baumgartner RN, Rubenstein LZ, Garry PJ. One-leg balance is an important predictor of injurious falls in older persons. *J Am Geriatr Soc* 1997; **45**: 735-738.
- 30 Guralnik JM, Simonsick EM, Ferrucci L *et al.* A short physical performance battery assessing lower extremity function: association with self-reported disability and prediction of mortality and nursing home admission. *J Gerontol* 1994; **49**: M85-M94.
- 31 Crouter SE, Schneider PL, Karabulut M, Bassett DR Jr. Validity of 10 electronic pedometers for measuring steps, distance, and energy cost. *Med Sci Sports Exerc* 2003; **35**: 1455-1460.
- 32 Rosano C, Aizenstein HJ, Studenski S, Newman AB. A regions-of-interest volumetric analysis of mobility limitations in community-dwelling older adults. *J Gerontol A Biol Sci Med Sci* 2007; **62**: 1048-1055.
- 33 Royall DR, Rauch R, Román GC, Cordes JA, Polk MJ. Frontal MRI findings associated with impairment on the Executive Interview (EXIT25). *Exp Aging Res* 2001; **27**: 293-308.
- 34 Rabbitt PM, Scott M, Thacker N *et al.* Balance marks cognitive changes in old age because it reflects global brain atrophy and cerebro-arterial blood-flow. *Neuropsychologia* 2006; **44**: 1978-1983.
- 35 AGS Guidelines. Guideline for the prevention of falls in older persons. American Geriatrics Society, British Geriatrics Society, and American Academy of Orthopaedic Surgeons Panel on Falls Prevention. *J Am Geriatr Soc* 2001; **49**: 664-672.
- 36 Herman T, Mirelman A, Giladi N, Schweiger A, Hausdorff JM. Executive control deficits as a prodrome to falls in healthy older adults: a prospective study linking thinking, walking, and falling. *J Gerontol A Biol Sci Med Sci* 2010; **65**: 1086-1092.

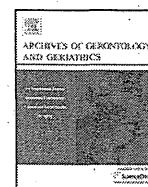

Maladaptive turning and gaze behavior induces impaired stepping on multiple footfall targets during gait in older individuals who are at high risk of falling

Minoru Yamada^{a,*}, Takahiro Higuchi^b, Shuhei Mori^a, Kazuki Uemura^c, Koutatsu Nagai^a, Tomoki Aoyama^a, Noriaki Ichihashi^a

^a Department of Human Health Sciences, Kyoto University Graduate School of Medicine, 53 Kawahara-cho, Shogoin, Sakyo-ku, Kyoto 606-8507, Japan

^b Department of Health Promotion Science, Graduate School of Human Health Science, Tokyo Metropolitan University, 1-1 Minami-Ohsawa, Hachioji, Tokyo 192-0397, Japan

^c Department of Physical Therapy, Graduate School of Medicine, Nagoya University, 1-1-20 Daikouminami, Higashi-ku, Nagoya 461-8673, Japan

ARTICLE INFO

Article history:

Received 18 June 2011

Received in revised form 18 August 2011

Accepted 20 August 2011

Available online 9 September 2011

Keywords:

Gaze behavior

Falls

Older

MTST

ABSTRACT

It was recently reported that the measurement of stepping accuracy while performing a new walking test, a multi-target stepping task (MTST), could contribute to identifying older individuals at high risk (HR) of falling. The present study was designed to identify factors leading HR older individuals to an impaired stepping performance in terms of frequency of maladaptive turning behavior (spin turn) and spatio-temporal patterns of fixations. Eleven HR (80.8 ± 3.6 years), 26 low-risk (LR) (77.1 ± 7.7 years) older individuals, and 20 younger individuals performed the MTST. For the MTST, stepping accuracy was measured with two types of failure (stepping target and avoiding distracters). The frequency of a spin turn (i.e., a crossover step) was compared among the groups. The location and duration of each fixation were also compared. The HR older and younger participants showed a higher rate of spin turns. Whereas the younger participants fixated approximately three steps ahead, the older participants directed their fixation closer toward the imminent footfall target, demonstrating their difficulty to use the visual information regarding the target in a feedforward manner. Such patterns of fixations were significantly associated with the frequency of stepping and avoidance failures. The higher rate of stepping and avoidance failures in the MTST were attributed to maladaptive turning behavior, which is potentially destabilizing, and the tendency to fixate on/around an imminent footfall target, which prevented older individuals from considering the locations of future footfall targets.

© 2011 Elsevier Ireland Ltd. All rights reserved.

1. Introduction

Older individuals who are at high risk for a fall generally exhibit increased gait variability (Verghese et al., 2009; Brach et al., 2010), a decline in visuomotor control of foot movement (Chapman and Hollands, 2006a,b, 2007), and cognitive impairment, particularly in executive functions (Alexander et al., 2005; Persad et al., 2008; Herman et al., 2010). As a result, when instructed to step precisely on a footfall target on the ground, they show more impaired performance than older individuals who are at low risk for a fall (Chapman and Hollands, 2006b, 2007). Measurement of stepping accuracy during gait is therefore useful as a clinical tool to distinguish HR older individuals from LR older individuals.

Recently, we developed a new clinical test, a multi-target stepping task, to measure the stepping accuracy in a simplified manner (Yamada et al., 2011). In the MTST, participants were instructed to step on an assigned square (the footfall target)

continuously along the 15 lines while avoiding the other squares (distracters). The results demonstrated that 64.5% of HR older participants failed to step precisely on the target at least once (referred to as a stepping failure). The HR older participants also showed a significantly higher rate of failure to avoid stepping on distracters (avoidance failure) than LR older participants. A logistic regression analysis showed a significantly high odds ratio for the stepping failure (19.365), although the very large range of 95% CI (3.28–113.95) indicated that the results need to be interpreted cautiously. These findings led us to the tentative conclusion that measuring the stepping accuracy while performing the MTST is potentially an important factor in the identification of HR older individuals.

Understanding factors contributing to enhance a predictive power of the MTST to identify HR older individuals is necessary for its clinical use and a development of an intervention technique to improve stepping accuracy while performing the MTST. For this purpose, the present study was designed to measure two behaviors while performing the MTST: turning and gaze behavior.

Inaccurate stepping performance may well result from maladaptive strategies for stepping in a different direction, i.e.,

* Corresponding author. Tel.: +81 75 751 3964; fax: +81 75 751 3909.
E-mail address: yamada@hs.med.kyoto-u.ac.jp (M. Yamada).

turning behavior. The placement of multiple targets in the MTST could lead participants to turn quickly in a different direction. HR older individuals generally show difficulty in maintaining a stabilized posture after stepping in a different direction (Dite and Temple, 2002; Tseng et al., 2009). Two main strategies for turning exist: step and spin turns. Whereas a step turn involves a change in the direction opposite to the stance limb, the spin turn is taking a crossover step, i.e., changing in the direction toward the same side of the stance limb. A spin turn is potentially destabilizing because, if appropriate pro-active action is not taken, the center of mass (COM) of the body will be outside of the base of support (BOS) (Moraes et al., 2004; Taylor et al., 2005). We hypothesized that impaired stepping performance while performing the MTST in HR older individuals was accompanied by more frequent spin turns.

Spin turns could occur more frequently when participants concentrated on stepping accurately on an imminent footfall target and did not consider the locations of future footfall targets. Measuring gaze behavior while performing the MTST was an effective approach to address this issue. By measuring how far ahead the fixation was located, we examined whether age-related differences existed in the visual scanning of footfall targets while performing the MTST.

The hypothesis regarding the location of fixation was that fixation in older individuals should be directed closer toward an imminent footfall target. The spatial demand of stepping in the MTST is relatively moderate, considering the criteria that even a step on the edge of the target was regarded as successful. Under such moderate conditions, younger individuals generally fixate a few steps ahead to step on multiple footfall targets (Patla and Vickers, 2003). This means that visual information regarding the location of an imminent footfall target is used in a feedforward manner, i.e., based on "stored" visuospatial information (Zettel et al., 2008), rather than in an on-line, feedback manner. In contrast, older individuals have difficulty using vision in a feedforward manner (Chapman and Hollands, 2006a). It was therefore hypothesized that fixation in older individuals should be directed closer toward an imminent footfall target.

To further understand the characteristics of gaze behavior in HR older individuals, we examined the duration of each fixation, particularly toward a target. Chapman and colleagues demonstrated that HR older individuals looked at targets longer when they walked while stepping on multiple footfall targets with relatively strict spatial demand (Chapman and Hollands, 2006b, 2007). With these findings, they proposed that they would require more time to process visual information regarding targets and/or program appropriate motor responses. We investigated whether a similar tendency would occur while they performed the MTST in spite of its moderate spatial demand.

Our primary analyses were to compare stepping performances, turning and gaze behaviors among the HR older, LR older, and the younger control groups. In addition, it was important to address which of several measurements were significantly associated with stepping avoidance failures. To do so, secondary analyses were conducted. Older participants were divided into two groups according to whether they had experienced stepping and avoidance failures (i.e., regardless of whether they were in the HR or older LR group). Each measurement regarding gaze behavior and other clinical measurements were compared statistically between the two groups. Furthermore, to determine whether the maladaptive spin turn occurred as a result of the participants' fixation being directed closer to the target, we conducted another statistical analysis in which the older participants were divided into two groups according to their experience of the spin turn. Comparisons of the gaze behavior were made between the two groups.

2. Methods

2.1. Participants

A total of 37 community-dwelling older individuals (mean age, 78.1 ± 6.8 years) participated. The exclusion criteria ensured that none of the participants had any indications of the following symptoms: (a) serious visual impairment (cataract, glaucoma, or color blindness), (b) inability to ambulate independently (those requiring the assistance of a walker were excluded), (c) score of less than 7 on the Rapid Dementia Screening Test (Kalbe et al., 2003), (d) symptomatic cardiovascular disease, (e) neurological and orthopedic disorders, (f) peripheral neuropathy of the lower extremities, or (g) severe arthritis. None of them had performed the MTST before. Twenty younger individuals (mean age, 21.1 ± 1.4 years) also took part in this experiment as control participants. Written informed consent was obtained from each subject in accordance with the guidelines approved by the Kyoto University Graduate School of Medicine and the Declaration of Human Rights, Helsinki, 1975.

Following an earlier study (Yamada et al., 2011), a participant who met the following two criteria was classified as an HR older individual: (a) a self-report of the occurrence of at least one fall within the past year and (b) a time requirement greater than 13.5 s for performing a Timed Up and Go test (TUG) (Shumway-Cook et al., 2000). A fall was defined as any event that led to an unplanned, unexpected contact with a supporting surface during walking. Our definition that the experience of falls was restricted to those during walking (i.e., falls during standing or transferring were not included) was suitable for the present study, considering that the MTST was developed to differentiate older HR individuals from LR ones in terms of stepping accuracy during walking. We ensured that none of the participants had any fall experience during standing or transferring.

As a result, 11 HR and 26 LR elderly individuals participated (see Table 1 for participant details). A one-way ANOVA conducted for each data of age, height, weight, the score of the Rapid Dementia Screening Test, and the visual acuity score (binocular acuity scored on the basis of a Landolt C) showed no significant differences between the HR and LR groups (Table 1). A Chi-square analysis conducted for the data of gender distribution also showed no significant differences between the HR and LR groups (Table 1).

2.2. Setup and protocols for data collection of the MTST

The MTST was performed on a black elastic mat (10 m long and 1 m wide). There were 45 pieces of a 10 cm \times 10 cm square on the mat (see Fig. 1a). These squares were arranged into three rows (15 cm between each row) and 15 lines (61 cm between each line). Each square was marked with red, blue, or yellow tape. Each line had one of the three colored squares in a randomized order. One square (blue or yellow) was regarded as a footfall target, while the others were distracters.

Gaze behavior was measured using a head-mounted eye tracker (EMR-9, Nac Image Technologies, Japan). The eye tracker we used was a binocular corneal reflection system that measures the eye line of gaze with respect to a hat. The participant's gaze was indicated by a circle mark on a video-based image of the visual field as recorded by a scene camera mounted on the hat at a temporal resolution of 30 Hz (see Fig. 1b). Three-dimensional accelerometers (WAA-006, ATR-Promotions, Japan) were attached to each heel to measure the timing of participants' heel contact for each stepping.

The participants wore flat-soled footwear and walked on the mat at a self-selected pace while stepping on the target square placed on each line without stepping on the distracters. The participants performed two main trials. For each trial, a different color square was assigned as a footfall target. Detailed information

Table 1
Group comparisons of the characteristics of participants, MTST performance, gaze behavior, and other clinical tests.

	HR older (n=11)		LR older (n=26)		Younger (n=20)		ANOVA		
	Mean	SD	Mean	SD	Mean	SD	p value		
Participant details									
Age	80.8	3.6	77.1	7.7	21.1	1.4	<0.001*	b,c	
Height, cm	155.1	8.8	153.8	10.2	164.4	9.7	<0.001*	b,c	
Weight, kg	48.8	5.8	55.5	10.1	56.3	9.0	<0.001*	b	
Gender (male=0, female=1), %		63.6		61.5		50.0			
Rapid Dementia Screening Test, point	8.91	1.13	9.27	1.60	12.00	0.00	<0.001*	b,c	
Vision acuity score, decimal	0.75	0.39	0.77	0.30	0.73	0.33	0.885		
MTST performance									
Stepping failure (yes=1, no=0), %		72.7		7.6		0.0		a,b	
Number of stepping failure, times	0.7	0.5	0.1	0.3	0.0	0.0	<0.001*	a,b	
Avoidance failure (yes=1, no=0), %		100.0		15.3		0.0		a,b	
Number of avoidance failure, times	3.7	2.9	0.5	1.6	0.0	0.0	<0.001*	a,b	
Performance time, s	36.2	4.0	29.8	8.9	18.7	6.2	<0.001*	b,c	
Stepping interval time, s	2.8	0.4	2.5	1.4	1.2	0.4	<0.001*	b,c	
Spin (yes=1, no=0), %		63.6		15.3		50.0		a,c	
Gaze toward target									
Gaze duration, s	0.85	0.38	0.78	0.63	0.62	0.24	0.402		
Gaze initiation, s (before stepping)	1.36	0.26	1.94	1.09	3.54	1.56	<0.001*	b,c	
Gaze termination, s (before stepping)	0.52	0.42	1.17	0.97	2.91	1.60	<0.001*	a,b,c	
Initiation/interval	0.50	0.09	0.89	0.53	2.94	1.21	<0.001*	a,b,c	
Termination/interval	0.19	0.16	0.61	0.56	2.41	1.27	<0.001*	a,b,c	
Other clinical tests									
10 m walking time, s	16.1	2.7	11.5	3.7			t-Test	0.001*	
Timed Up and Go, s	19.8	4.3	13.1	4.4				<0.001*	
One leg stand, s	1.2	1.5	9.3	12.7				0.005*	
Functional reach, cm	18.3	3.9	24.1	4.7				0.006*	
5 chair stand, s	19.7	11.2	13.3	3.5				0.020	

ANOVA: Bonferroni correction $p=0.016$ (0.05/3).

Post hoc test: $p<0.016$.

^a Post hoc test: HR vs LR.

^b Post hoc test: HR vs young.

^c Post hoc test: LR vs young.

about the protocol of the MTST has been given in an earlier study (Yamada et al., 2011).

2.3. Data analyses of the MTST

All dependent measures were obtained only from the first main trial (Yamada et al., 2011). This was because, as other clinical standard tests used for identifying HR older individuals, the MTST

had been developed so that participants could complete the task in a short time. The earlier study demonstrated that analyzing stepping performance in a single trial was effective to identify HR older individuals (Yamada et al., 2011). The stepping performance obtained from the second main trial was used only to calculate test–retest reliability.

The main dependent measures were two types of failure indicating less accurate stepping performance: a stepping failure

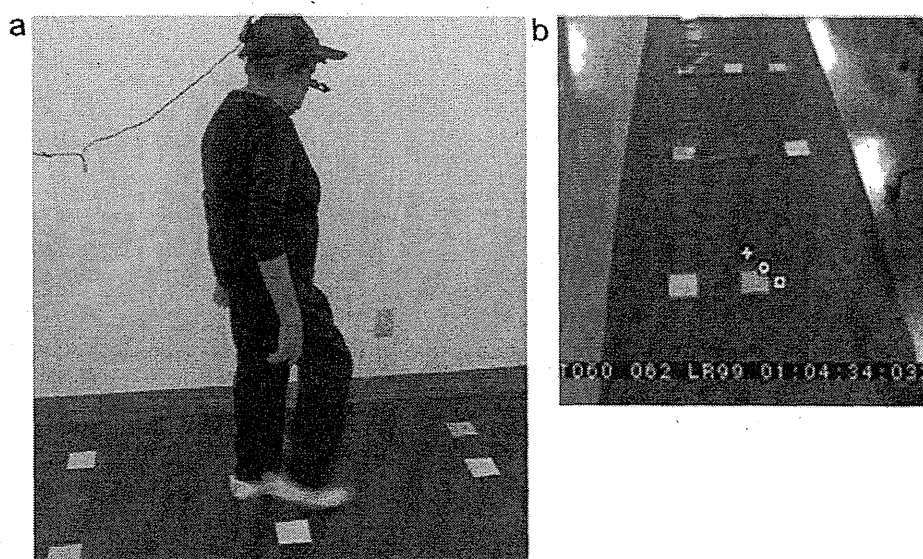

Fig. 1. (a) An older participant performing the MTST. Each square in each line was made of red, blue, or yellow tape. The participant intended to walk at a self-selected pace while stepping on a target square of an assigned color while avoiding to step on other squares. (b) A video-based image of the visual field while performing the MTST. The location of fixation, indicated by a circle mark, was calculated with the information obtained from the left (a plus mark) and right (a square mark) eyes.

(i.e., failure to step on the footfall target) and an avoidance failure (i.e., failure to avoid distracters). Even a step on the edge of the target was regarded as successful. These measures were analyzed statistically from two perspectives. First, the participants who experienced each type of failure at least once were totaled for both the HR and LR groups. For each failure, the numbers, expressed as the frequency of failure occurring in the group (%), were compared statistically among the groups with a Chi-square analysis. Secondly, the number of failures for each participant was statistically compared among the groups with a one-way analysis of variance (ANOVA). To investigate the test–retest reliability for the two types of the stepping failure, Kappa coefficients (*k*-values) between the two trials were calculated. A *k*-value of 0.61–0.80 was regarded as good agreement (Naessens et al., 2010).

The time (s) taken to perform the MTST, referred to as the MTST performance time, was measured with a stopwatch. The time of the interval between each step was also measured with the accelerometers attached to each heels. The timing of each step was defined as the time when peak acceleration occurred in the vertical direction. Each MTST performance time and stepping interval was compared statistically among the groups with a one-way ANOVA. To investigate the test–retest reliability for the MTST performance time, the inter-trial correlation coefficient (ICC 1.1) between the two trials was calculated.

Regarding the frequency of the maladaptive turning behavior (spin turn), the participants who experienced crossover steps at least once in a trial were totaled for each of the three groups. The frequencies of failure occurring in the group (%) were compared statistically among the groups with a Chi-square analysis. To investigate the test–retest reliability for the frequency of the spin turn, a *k*-value between the two trials was calculated.

Frame-by-frame video-based analyses were performed to identify where fixations were located. Stabilization of the gaze at one location for a minimum of 100 ms (three video frames) was defined as a fixation. The locations of fixations were classified into one of four categories: target, distracter, path, or other. The durations of each fixation were quantified and statistically compared among the groups using a one-way ANOVA. To statistically test the fixation patterns, each participant's average fixation time, as a percentage of total fixations, in each fixation-location was compared among the groups using a one-way ANOVA.

2.4. Data collection and analyses of gaze behavior

For the purpose of examining how far ahead the participants' fixations were located, the time to initiate (referred to as gaze initiation) and terminate (gaze termination) gazing at a given target before stepping on it was measured. The data of the gaze initiation (termination) were calculated by subtracting the time to initiate (terminate) fixation toward the imminent footfall target from the time to step on the target, which was obtained through the three-dimensional accelerometers attached to each heel. Dividing these timing data by the duration of the stepping interval (referred to as initiation/interval and termination/interval) expressed the degree to which the participants directed their fixation toward a future target. For instance, when the value of initiation/interval was 1.0 (i.e., the duration between the initiation of fixation toward a certain target and stepping on that target was equal to the duration of the stepping interval), a participant began to fixate a next footfall target just when stepping on the imminent footfall target. A value smaller than 1.0, therefore, meant that a fixation was directed toward the imminent target, whereas a value larger than 1.0 meant that a fixation was directed toward a future footfall target. A one-way ANOVA was used to compare these measurements statistically among the groups.

2.5. Data collection and analyses of other clinical tests

Other clinical tests that have been used to identify high-risk elderly adults in many studies, i.e., the TUG (Podsiadlo and Richardson, 1991), the functional reach test (FR) (Duncan et al., 1992), the one-leg standing test (OLS) (Vellas et al., 1997), the 10 m walking test (10 m walking) (Lopopolo et al., 2006), and the 5-chair stand (5CS) test (Guralnik et al., 1994), were measured prior to performing the MTST on the first measurement day. All tests except the 5CS were used in the earlier study (Yamada et al., 2011). In the 5CS, participants were asked to stand up and sit down five times as quickly as possible. A 5CS score was defined as the average of two trials regarding the time in seconds for the completion of this task. The order in which these tests were performed was randomized. The participants performed each task for two trials. A *t*-test analysis was examined for each clinical test to statistically compare the scores between the HR and LR groups.

2.6. Associations among the measurements

To quantitatively describe the associations between the stepping accuracy in the MTST and other measurements, the 37 older participants were divided into two groups according to whether they experienced both stepping and avoidance failures or not. Each of all measurements regarding gaze behavior and the clinical tests was compared statistically between the two groups with a *t*-test. To examine whether a spin turn was likely to occur when a participant's fixations were directed closer to an imminent footfall target, the participants were also divided into two groups according to whether they experienced a spin turn. Each of all measurements regarding gaze behavior was compared statistically between the two groups with a *t*-test. Furthermore, whether the experience of a spin turn was associated with the scores of the clinical tests was also analyzed. A comparison with a *t*-test was performed between the two groups.

2.7. Adjustment of a significance level for multiple statistical comparisons

In the present study, three different analyses were undertaken with the same data set (i.e., a comparison among the HR, LR older and young groups, and two two-group comparisons for testing associations among the measurements). To avoid a risk of committing a Type 1 error, the alpha-level was adjusted for multiple comparisons using the Bonferroni correction (Feise, 2002). In particular, the alpha-level of 0.05 was corrected to reflect five different comparisons, resulting in an adjusted alpha of 0.016 (0.05/3).

3. Results

3.1. MTST performance, gaze behavior, and clinical tests (Table 1 and Fig. 2)

The HR older participants experienced significantly higher frequency of both stepping and avoidance failures than the LR older and younger participants. The average number of each failure occurring in each group was greater for the HR older participants than for the LR older and younger participants. Both the MTST performance time and the stepping interval were significantly shorter for the younger participants than the HR and LR older participants. The HR older and younger participants experienced significantly higher frequency of the spin turns than the LR participants. The investigation of the test–retest reliability indicated that the *k*-value was 0.724 for the stepping failure, 0.746 for the avoidance failure, and 0.877 for the spin turn. The

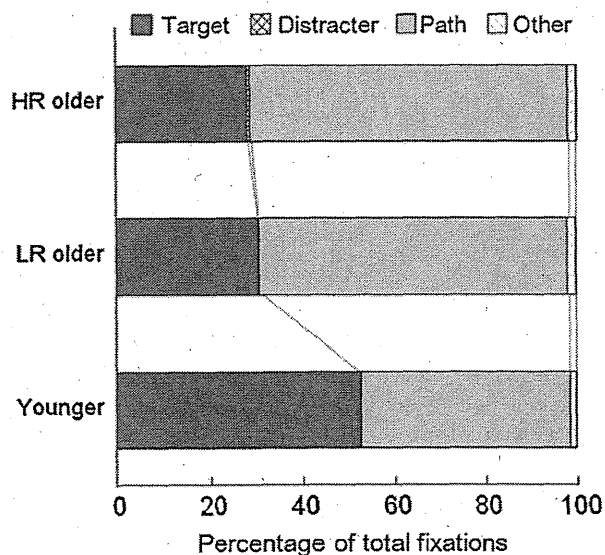

Fig. 2. Frequency of fixation directed toward each location in each group. The location-category of the distracter is not included because none of the participants fixated toward the distracters.

correlation between the first- and second-time measurements of the MTST performance time was very high (ICC = 0.969 (95%CI: 0.954–0.979)).

The group differences in the gaze duration were not statistically significant. The timing of gaze initiation was significantly earlier for the younger participants than the HR and LR older participants. The difference in this measurement was not significant between the HR and LR participants. The differences in the gaze termination, initiation/interval, and termination/interval were all significant for each pair in the three groups. The average percentages of total fixation durations (Fig. 2) showed that the fixation was directed toward the target more frequently for the younger participants than for the HR and LR older participants ($p < 0.016$). Participants rarely directed their fixation toward the distracters (0.4, 0.2, and 0% for the HR, LR, and younger groups, respectively). The younger participants directed their fixation toward the path less frequently than the HR and LR participants ($p < 0.016$).

Comparison of the performances in other clinical tests between the HR and LR participants showed that the HR older participants showed a significantly lower score than the LR older participants in all clinical tests except the 5CS.

3.2. Associations among the measurements (Tables 2 and 3)

Eight older participants experienced both stepping and avoidance failures (other two participants experienced only stepping failures, whereas seven experienced only avoidance failures). Regarding the association of stepping accuracy with gaze behavior and clinical tests (Table 2), the participants who experienced both failures initiated and terminated fixation toward an imminent target significantly later than those who did not. The mean values of initiation/interval and termination/interval were significantly greater for the participants who experienced both types of failures than for those who did not. The participants who experienced both failures showed significantly lower scores for the TUG, OLS, and FR than the participants who did not. No significant differences in all measurements on gaze behavior and on the clinical tests were identified between the participants who experienced a spin turn and those who did not (Table 3).

4. Discussion

The purpose of the present study was to examine whether maladaptive turning and gaze behavior existed while HR older individuals were performing the MTST. Before discussing this issue it is important to address that the present findings successfully replicated earlier ones (Yamada et al., 2011) regarding the fact that the HR older participants showed less stepping accuracy in the MTST. The HR older participants showed a significantly higher rate of stepping and avoidance failures than the LR older and younger participants. It is noteworthy that avoidance failure always occurred as a result of an accidental step in the way the participants were walking from target to target but not as a result of the wrong selection of a target from the three squares in the line that they intended to step on. Avoidance failure, therefore, resulted mainly from incorrect planning of the walking path from target to target and not from the wrong selection of a target from the three squares in a line due to impaired contrast sensitivity. The test-retest examination showed that these measurements were statistically reliable. These findings supported the conclusion of the earlier study (Yamada et al., 2011) that measuring the stepping accuracy while performing the MTST is potentially an important factor in the identification of HR older individuals.

Analysis of the frequency of the spin turn supported the hypothesis that impaired stepping performance in HR older individuals was accompanied with more frequent spin turns. Seven out of 11 HR older participants (63.6%) made a spin turn at least once to change their walking direction. In contrast, many of the LR older participants (22 out of 26 participants) did not select a

Table 2
Associations of the experience of stepping and avoidance failures with gaze behavior and clinical tests.

	Failure				p value	E/S
	Yes (n = 8)		No (n = 29)			
	Mean	SD	Mean	SD		
Gaze toward target						
Gaze duration, s	0.87	0.40	0.78	0.61	0.61	0.24
Gaze initiation, s (before stepping)	1.28	0.26	1.97	1.06	0.01*	2.63
Gaze termination, s (before stepping)	0.41	0.35	1.13	0.93	0.00*	2.05
Initiation/interval	0.50	0.11	0.85	0.51	0.00*	3.10
Termination/interval	0.17	0.17	0.57	0.54	0.00*	2.36
Other clinical tests						
10 m walking time, s	14.92	1.77	12.23	4.23	0.02	1.52
Timed Up and Go, s	17.67	1.75	14.41	5.75	0.01*	1.86
One leg stand, s	0.76	1.18	9.06	12.52	0.00*	7.05
Functional reach, cm	19.67	1.37	23.52	5.42	0.00*	2.82
5 chair stand, s	17.25	10.10	14.17	5.41	0.30	0.30

Bonferroni correction $p = 0.016$ (0.05/3).

Table 3
Associations of the experience of spin turns with gaze behavior and clinical tests.

	Spin turn				p value	E/S
	Yes (n=11)		No (n=26)			
	Mean	SD	Mean	SD		
Gaze toward target						
Gaze duration, s	0.80	0.36	0.79	0.64	0.959	0.020
Gaze initiation, s (before stepping)	1.49	0.47	1.89	1.09	0.127	0.850
Gaze termination, s (before stepping)	0.69	0.68	1.10	0.95	0.152	0.600
Initiation/interval	0.65	0.34	0.83	0.52	0.242	0.510
Termination/interval	0.34	0.39	0.55	0.55	0.201	0.530
Other clinical tests						
10 m walking time, s	12.6	3.3	12.8	4.4	0.917	0.040
Timed Up and Go, s	15.3	3.9	15.0	5.9	0.860	0.080
One leg stand, s	4.1	5.8	9.1	13.5	0.161	0.860
Functional reach, cm	21.3	2.9	23.5	5.9	0.193	0.750
5 chair stand, s	15.5	8.2	14.4	5.7	0.701	0.140

Bonferroni correction $p = 0.016$ (0.05/3).

spin turn. This suggests that the LR older individuals successfully avoided the risk of destabilization while performing the MTST. The existence of such a clear difference in turning strategy between the HR and LR older participants is likely to contribute to enhancing the predictive power of the MTST to identify HR older individuals.

Interestingly, the younger participants also showed a higher rate of spin turns. A similar finding was reported in a previous study (Moraes et al., 2004), which demonstrated that their young participants preferred stepping medially (i.e., making a spin turn) rather than stepping laterally (i.e., making a step turn) to avoid a planar obstacle. The authors argued that modification of foot placement in response to an obstacle involves minimum displacement of the foot from its normal landing spot; stepping medially could be more suitable to satisfy this goal than stepping laterally. According to these previous findings, the younger participants in the present study may have not hesitated to select a spin turn because they had the ability to take pro-active action to bias the location of COM to ensure that it did not fall outside the BOS.

Analysis of gaze behavior supported another hypothesis that fixation in older individuals should be directed closer toward the imminent footfall target. The measurements of the initiation/interval and termination/interval revealed that the HR and LR older participants directed their gaze toward the imminent footfall target. Such a tendency was significantly higher for the HR older participants than the LR older ones. In contrast, the younger participants directed their gaze toward approximately 3 targets ahead. These findings clearly supported previous findings that, whereas younger individuals use visual information regarding the location of an imminent footfall target in a feedforward manner, older individuals appear to use it in an online, feedback manner (Patla and Vickers, 2003; Chapman and Hollands, 2006a).

Analyses of the association of stepping accuracy with gaze behavior demonstrated that the observed fixation patterns in the HR older participants were related to the stepping and avoidance failures (Table 2). The participants who experienced both the stepping and avoidance failures initiated and terminated fixation toward an imminent target significantly later than those who did not. From these findings, we suggest that one of the reasons for the higher rate of stepping and avoidance failures in the HR older individuals could be attributed to their tendency to fixate on/around the imminent footfall target, which prevented them from considering the locations of future footfall targets.

The HR older participants showed a higher rate of failure of stepping on the footfall targets in spite of the fact that they concentrated on fixation toward the imminent footfall target. The measurements of gaze termination showed that, on average, the HR older participants terminated fixation on the imminent footfall

target approximately 0.5 s before stepping on that target. This indicated that they did not fixate on the imminent footfall target until they stepped on it; that is, the imminent footfall target was captured through peripheral vision or out of sight. The present findings suggest that the observed spatiotemporal patterns of fixation toward the imminent footfall target in the HR older participants may not have led to accurate foot control for stepping on a footfall target. Similarly, the average percentages of total fixation durations (Fig. 2) demonstrated that the participants rarely fixated toward the distractors (only 0.4% of total fixation times for the HR older, 0.2% for the LR older, and 0% for the younger participants). This suggests that the information regarding the locations of the distractors was obtained through peripheral vision (Patla and Vickers, 1997; Zietz and Hollands, 2009; Miyasike-daSilva et al., 2011). The failure to avoid the distractors may have resulted from their impaired ability to control their foot placement based on peripheral vision (Di Fabio et al., 2005).

The duration of fixation was not significantly different among the groups. This was inconsistent with previous findings demonstrating that HR individuals looked at footfall targets longer (Chapman and Hollands, 2006b, 2007). The contradictory findings between the previous and present studies may have been attributed to the difference in the spatial demand for stepping between these studies. In other words, a longer target fixation of the target would have been necessary when the spatial demand for stepping on the target was relatively strict, as in previous studies. Alternatively, given that the fixation was directed toward the path more frequently for the HR and LR older participants (Fig. 2), fixation on the place of each step, rather than on the target alone, may have been necessary while the HR older participants were performing the MTST. As a result, they may not have directed their fixation toward the target for a particularly longer time.

Theoretically, a spin turn could occur more frequently as fixation was located closer toward the imminent footfall target and, as a result, the locations of future footfall targets were not considered. However, we failed to demonstrate a significant association between the frequency of the spin turn and the pattern of fixations (Table 3). In fact, the experience of a spin turn was not significantly associated with any measurements about gaze behavior and other clinical tests. The precise mechanism for causing maladaptive turning behavior remains unclear. A future study should address this issue.

Analyses of the association of stepping accuracy with other clinical measurements demonstrated that the participants who experienced both stepping and avoidance failures showed lower scores for the TUG, OLS, and FR (Table 2). This was generally consistent with the findings in our earlier study (Yamada et al.,

2011), which demonstrated that the number of avoidance failures showed mild negative correlation with the performance of the TUG and OLS. These findings suggest that impaired stepping performance in the MTST was likely to be associated with the impairment of general balance abilities, lower extremity function, and mobility.

In conclusion, the present study demonstrated impaired stepping performance of the HR older individuals in the MTST was accompanied with their maladaptive turning and gaze behavior. One of the most important findings was that the HR older individuals fixated closer toward the imminent footfall target. This suggests that they have difficulty in using visual information regarding the location of an imminent footfall target in a feedforward manner. Such a pattern of fixations would prevent them from considering the locations of future footfall targets and, therefore, can cause a maladaptive strategy to step in a different direction. In fact, the stepping performance in HR older individuals was accompanied with more frequent spin turns. Due to the lack of a significant association of the spin turn with the patterns of fixations, future studies should identify a precise mechanism for selecting the maladaptive turning behavior.

Funding

None.

Conflict of interest statement

None.

References

- Alexander, N.B., Ashton-Miller, J.A., Giordani, B., Guire, K., Schultz, A.B., 2005. Age differences in timed accurate stepping with increasing cognitive and visual demand: a walking trail making test. *J. Gerontol. A: Biol. Sci. Med. Sci.* 60, 1558–1562.
- Brach, J.S., Perera, S., Studenski, S., Katz, M., Hall, C., Verghese, J., 2010. Meaningful change in measures of gait variability in older adults. *Gait Posture* 31, 175–179.
- Chapman, G.J., Hollands, M.A., 2006a. Age-related differences in stepping performance during step cycle-related removal of vision. *Exp. Brain Res.* 174, 613–621.
- Chapman, G.J., Hollands, M.A., 2006b. Evidence for a link between changes to gaze behaviour and risk of falling in older adults during adaptive locomotion. *Gait Posture* 24, 288–294.
- Chapman, G.J., Hollands, M.A., 2007. Evidence that older adult fallers prioritise the planning of future stepping actions over the accurate execution of ongoing steps during complex locomotor tasks. *Gait Posture* 26, 59–67.
- Di Fabio, R.P., Zampieri, C., Henke, J., Olson, K., Rickheim, D., Russell, M., 2005. Influence of elderly executive cognitive function on attention in the lower visual field during step initiation. *Gerontology* 51, 94–107.
- Dite, W., Temple, V.A., 2002. A clinical test of stepping and change of direction to identify multiple falling older adults. *Arch. Phys. Med. Rehabil.* 83, 1566–1571.
- Duncan, P.W., Studenski, S., Chandler, J., Prescott, B., 1992. Functional reach: predictive validity in a sample of elderly male veterans. *J. Gerontol.* 47, M93–M98.
- Feise, R.J., 2002. Do multiple outcome measures require *p*-value adjustment? *BMC Med. Res. Methodol.* 2, 1–4.
- Guralnik, J.M., Simonsick, E.M., Ferrucci, L., Glynn, R.J., Berkman, L.F., Blazer, D.G., Scherr, P.A., Wallace, R.B., 1994. A short physical performance battery assessing lower extremity function: association with self-reported disability and prediction of mortality and nursing home admission. *J. Gerontol.* 49, M85–M94.
- Herman, T., Mirelman, A., Giladi, N., Schweiger, A., Hausdorff, J.M., 2010. Executive control deficits as a prodrome to falls in healthy older adults: a prospective study linking thinking, walking, and falling. *J. Gerontol. A: Biol. Sci. Med. Sci.* 65, 1086–1092.
- Kalbe, E., Calabrese, P., Scgwalen, S., Kessler, J., 2003. The Rapid Dementia Screening Test (RDST): a new economical tool for detecting possible patients with dementia. *Dement. Geriatr. Cogn. Disord.* 16, 193–199.
- Lopopolo, R.B., Greco, M., Sullivan, D., Craik, R.L., Mangione, K.K., 2006. Effect of therapeutic exercise on gait speed in community-dwelling elderly people: a meta-analysis. *Phys. Ther.* 86, 520–540.
- Miyasike-daSilva, V., Allard, F., McIlroy, W.E., 2011. Where do we look when we walk on stairs? Gaze behaviour on stairs, transitions, and handrails. *Exp. Brain Res.* 209, 73–83.
- Moraes, R., Lewis, M.A., Patla, A.E., 2004. Strategies and determinants for selection of alternate foot placement during human locomotion: influence of spatial and temporal constraints. *Exp. Brain Res.* 159, 1–13.
- Naessens, J.M., O'Byrne, T.J., Johnson, M.G., Vansuch, M.B., McGlone, C.M., Huddleston, J.M., 2010. Measuring hospital adverse events: assessing inter-rater reliability and trigger performance of the Global Trigger Tool. *Int. J. Qual. Health Care* 22, 266–274.
- Patla, A.E., Vickers, J.N., 1997. Where and when do we look as we approach and step over an obstacle in the travel path? *Neuroreport* 8, 3661–3665.
- Patla, A.E., Vickers, J.N., 2003. How far ahead do we look when required to step on specific locations in the travel path during locomotion? *Exp. Brain Res.* 148, 133–138.
- Persad, C.C., Jones, J.L., Ashton-Miller, J.A., Alexander, N.B., Giordani, B., 2008. Executive function and gait in older adults with cognitive impairment. *J. Gerontol. A: Biol. Sci. Med. Sci.* 63, 1350–1355.
- Podsiadlo, D., Richardson, S., 1991. The Timed Up & Go: a test of basic functional mobility for frail elderly persons. *J. Am. Geriatr. Soc.* 39, 142–148.
- Shumway-Cook, A., Brauer, S., Woollacott, M., 2000. Predicting the probability for falls in community-dwelling older adults using the Timed Up & Go Test. *Phys. Ther.* 80, 896–903.
- Taylor, M.J., Dabnichki, P., Strike, S.C., 2005. A three-dimensional biomechanical comparison between turning strategies during the stance phase of walking. *Hum. Mov. Sci.* 24, 558–573.
- Tseng, S.C., Stanhope, S.J., Morton, S.M., 2009. Impaired reactive stepping adjustments in older adults. *J. Gerontol. A: Biol. Sci. Med. Sci.* 64, 807–815.
- Vellas, B.J., Wayne, S.J., Romero, L., Baumgartner, R.N., Rubenstein, L.Z., Garry, P.J., 1997. One-leg balance is an important predictor of injurious falls in older persons. *J. Am. Geriatr. Soc.* 45, 735–738.
- Verghese, J., Holtzer, R., Lipton, R.B., Wang, C., 2009. Quantitative gait markers and incident fall risk in older adults. *J. Gerontol. A: Biol. Sci. Med. Sci.* 64, 896–901.
- Yamada, M., Higuchi, T., Tanaka, B., Nagai, K., Uemura, K., Aoyama, T., Ichihashi, N., 2011. Measurements of stepping accuracy in a multi-target stepping task as a potential indicator of fall risk in elderly individuals. *J. Gerontol. A: Biol. Sci. Med. Sci.* 66, 994–1000.
- Zettel, J.L., McIlroy, W.E., Maki, B.E., 2008. Gaze behavior of older adults during rapid balance-recovery reactions. *J. Gerontol. A: Biol. Sci. Med. Sci.* 63, 885–891.
- Zietz, D., Hollands, M., 2009. Gaze behavior of young and older adults during stair walking. *J. Mot. Behav.* 41, 357–365.

ORIGINAL ARTICLE: EPIDEMIOLOGY,
CLINICAL PRACTICE AND HEALTH

Complex obstacle negotiation exercise can prevent falls in community-dwelling elderly Japanese aged 75 years and older

Minoru Yamada, Tomoki Aoyama, Hidenori Arai, Koutatsu Nagai, Buichi Tanaka, Kazuki Uemura, Shuhei Mori and Noriaki Ichihashi

Human Health Sciences, Kyoto University Graduate School of Medicine, Kyoto, Japan

Objectives: The aim of the present study was to evaluate whether a complex course obstacle negotiation exercise (CC), a 24-week exercise program, can reduce falls and fractures in older adults, as compared with a simple course obstacle negotiation exercise (SC).

Methods: This trial was carried out on older adults, aged 75 years and above in Japan. In total, 157 participants were randomized into the CC group ($n = 78$) and the SC group ($n = 79$). Participants were enrolled in the exercise class using the CC program or the SC program for 24 weeks. The outcome measure was the number of falls and fracture rates in CC and SC groups for 12 months after the completion of the 24-week exercise class.

Results: Two participants (2.8%) in the CC group and 19 (26.0%) in the SC group experienced falls during 12 months. During the 12-month follow-up period after the intervention, the incidence rate ratio (IRR) of falls in the SC group against the CC group was 9.37 (95% CI = 2.26–38.77). One participant (1.4%) in the CC group and eight (10.9%) in the SC group had experienced fractures during 12 months after the exercise class. The IRR of fractures in the SC group compared with the CC group was 7.89 (95% CI = 1.01–61.49).

Conclusions: The results of the present trial show that the participants who received individualized obstacle avoidance training under complex tasks combined with a traditional intervention had a lower incidence rate of falls and fractures during the 12 months after the intervention. *Geriatr Gerontol Int* 2012; 12: 461–467.

Keywords: fall prevention, obstacle negotiation exercise, older adults, randomized controlled trial.

Introduction

Falls are relatively common events in older people. One-third of community-dwelling people, aged 65 years and older, and up to 50% of those aged 80 years and older

experience a fall each year.^{1,2} A previous study also reported that in community-dwelling elderly individuals, over 50% of the falls are a result of trips and slips that usually occur during walking.³ In many of these cases, there is an external factor, such as an obstacle, that provokes and contributes to the fall.⁴ In addition, the incidence of osteoporotic fractures is reported to increase with age,⁵ and more than 50% of all fragility fractures in the community arise in women aged 75 years and older.⁶ A recent systematic review of fall prevention programs has convincingly shown that exercise interventions are effective for reducing the risk of

Accepted for publication 6 November 2011.

Correspondence: Mr Minoru Yamada PT PhD, Human Health Sciences, Kyoto University Graduate School of Medicine, 53 Kawahara-cho, Shogoin, Sakyo-ku, Kyoto 606-8507, Japan.
Email: yamada@hs.med.kyoto-u.ac.jp

falls and fall injuries.^{7,8} However, the kind of exercise intervention most effective for fall prevention is not fully addressed.

Concurrent cognitive or motor tasks, such as talking or carrying objects, are crucial for mobility in daily life. Because of the increasingly recognized role of cognition in postural control and gait, many researchers have used complex task paradigms incorporating a concurrent cognitive task to improve their studies investigating fall risk.⁹ Changes in performance during multitasking are significantly associated with an increased risk for falls in older adults.⁹ The ability to modulate attention might also play an important role in the acquisition of complex task coordination skills. Therefore, we developed a trail walking exercise (TWE), in which a person walks from numbered flags in either an ascending or descending order, to evaluate cognitive and motor function simultaneously.¹⁰ Our previous randomized controlled trial (RCT) showed that TWE has the benefit of decreasing the incidence of falls in community-dwelling elderly adults.

In everyday life, when walking in a challenging and distracting environment, older people might have to avoid ground level obstacles when their attention is divided. In this instance, obstacle-avoidance performance is likely to be further impaired, as shown by most multitask research among older adults.^{11–13} In addition, Jasmine *et al.* reported that when their attention is divided, older people negotiate obstacles more slowly and contact more obstacles.¹⁴ Therefore, in the present study, we added obstacles to the area of TWE (complex course obstacle negotiation) to mimic a “real world” walking environment with a high fall risk.

The present RCT examined the effect of fall and fall-related fracture prevention programs on attention demands of obstacles during walking under complex task conditions in community-dwelling elderly Japanese adults aged 75 years and older. The aim of the present study was to evaluate whether the complex course obstacle negotiation exercise (CC), a new 24-week exercise program, would be effective in reducing falls and fall-related fractures in community-dwelling older adults. We hypothesized that complex task walking is improved to a greater extent with the CC program than with the simple course obstacle negotiation exercise (SC). From these results, we can assume that the CC program is more effective in preventing falls and fall-related fractures than is the SC program.

Methods

Participants

Participants were recruited using an advertisement in the local press. The following criteria were used to screen participants in an initial interview: age 75 years

and older, community-dwelling, had visited a primary care physician within the past 3 years, had no severe cognitive impairment (Rapid Dementia Screening Test [RDST] score of 4 or less),¹⁵ can walk independently (or with a cane), willingness to participate in group exercise classes for at least 6 months, has access to transportation, has no significant hearing and vision impairments, and had no regular exercise in the past 12 months.

The interview was also used to exclude participants based on the following exclusion criteria: severe cardiac, pulmonary or musculoskeletal disorders; comorbidities associated with greater risk of falls, such as Parkinson disease and stroke; and use of psychotropic drugs. Written informed consent was obtained from each participant for the trial in accordance with the guidelines approved by the Kyoto University Graduate School of Medicine and the Declaration of Human Rights, Helsinki, 1975.

Study design and randomization

Participants were randomized into two groups. Opaque envelopes bearing group names were numbered and the 157 participants were then randomly assigned to either the CC ($n = 78$) or SC ($n = 79$) group.

Intervention

All participants received 45 min of group training sessions once a week for 24 weeks. Participants were randomly assigned to one of the two training groups: standardized training with CC and standardized training with SC.

The exercise class was individualized for each group and supervised by a physiotherapist. Each exercise class used a standardized format that included 10 min of moderate-intensity aerobic exercise, 15 min of progressive strength training, 10 min of flexibility and balance exercises, and 10 min of cool-down activities. The aerobic exercise consisted of movement of the legs, trunk and arms to involve all joints and major muscle groups in activities, such as dancing. Strength training consisted of progressive resistive exercises using an elastic band. A sequence of progressively more difficult exercises was also carried out to improve static and dynamic balance. Although exercises could be carried out in a sitting position, the importance of carrying the exercises out in a standing position to improve balance was stressed. Physiotherapists evaluated the participants twice during the study period to ensure adherence with exercise protocols during classes.

Complex course with obstacle negotiation exercise

In the CC training field, the flags and obstacles were positioned as shown in Figure 1.¹⁰ Flags were randomly

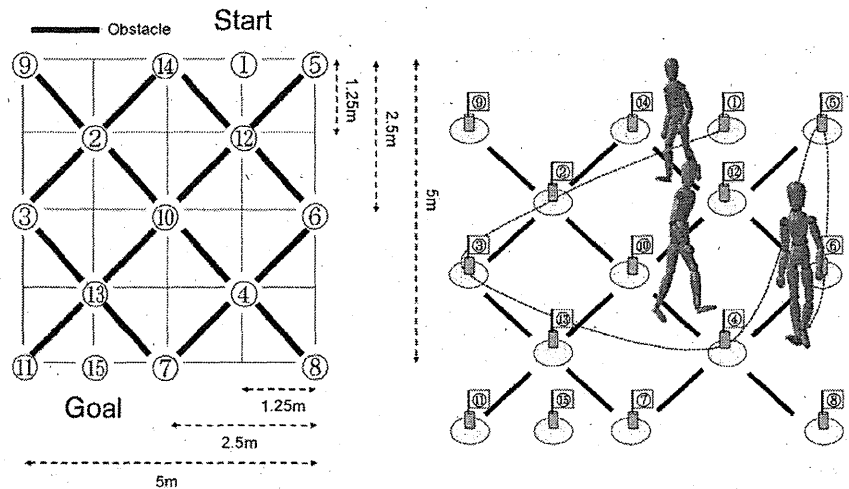

Figure 1 Schematic representation of the complex course obstacle negotiation exercise. Participants were asked to pass sequentially from numbers 1 to 15 as quickly and as correctly as possible during obstacle avoidance.

moved for each trial. Participants in the CC group were asked to sequentially pass from number 1 to 15 while avoiding the obstacles (Fig. 1). A 30-cm diameter circle was drawn on the ground around each flag, and the participants were required to step in the circle to pass the flag. The height of the flag was 30 cm. The tester gave the following instructions to participants, "Please move to flag number 15 as quickly and correctly as possible while avoiding obstacles". Throughout the weeks, the obstacles were made increasingly more difficult for participants to notice. The obstacles consisted of 16 wooden white (contrasting the floor colour) blocks (3, 100 and 1 cm in height, length and width, respectively) in weeks 1–6, wooden black blocks (2, 100 and 1 cm in height, width and depth, respectively) in weeks 7–12, wooden dark brown blocks (1, 100 and 1 cm in height, length and width, respectively) in weeks 13–18 and wooden brown (matching the floor colour) blocks (0.5, 100 and 1 cm in height, length and width, respectively) in weeks 19–24. Flag and obstacle positions were changed on each day of training. Participants carried out two sets of the CC program per training session.

Simple course with obstacle negotiation exercise

Participants were asked to walk along a walkway at a self-selected speed and to avoid contact with the obstacles. These sessions were designed as controls for the additional physical activity in the CC session. Participants walked along a level walkway, 15 m in length. The obstacles used in the simple course were as follows: six wooden white (contrasting the floor colour) blocks (3, 100 and 1 cm in height, length and width, respectively) in weeks 1–6, wooden black blocks (2, 100 and 1 cm in height, length and width, respectively) in weeks 7–12, wooden dark brown blocks (1, 100 and 1 cm in height, width and depth, respectively) in weeks 13–18,

wooden brown (matching the floor colour) blocks (0.5, 100 and 1 cm in height, length and width, respectively) in weeks 19–24. These obstacles were placed across the walkway at intervals randomly ranging from 30 to 150 cm for each day of training. Each participant carried out six walking trials.

Falls and fall-related fractures

The primary outcome of this trial was the occurrence of falls and fall-related fractures during the follow-up period of 12 months after the intervention was completed. Falls were defined as all situations in which a participant suddenly and involuntarily came to rest on the ground or at a surface lower than their original station.¹⁶ Falls resulting from extraordinary environmental factors (e.g. traffic accidents or falls while riding a bicycle) were excluded. The participants were asked to record any falls in fall diaries mailed every month by research assistants. If participants failed to send the fall diaries, research assistants collected data on falls over the telephone. All participants who had fallen were interviewed during these calls using a structured questionnaire about a fall event and its consequences. The diagnosis of fractures was based on radiological evidence of fracture.

Secondary outcome measures

For all participants, the following six measurements were obtained: 10-m walking time,¹⁷ the timed up and go (TUG) test,¹⁸ the functional reach (FR) test,¹⁹ the one-leg stand (OLS) test,²⁰ the SC test, and the CC test. A physiotherapist blinded to group allocation administered these measures at baseline, on completion of the 24-week intervention. All baseline measures were completed before randomization. Before the study started,

all staff members received training on correct protocols for administering all assessment measures included in the study from one of the authors (MY). If a walking aid was normally used at home, this aid was used during the TUG test, 10-m walking, SC test and CC test.

In the 10-m walking, participants walked 15 m at a speed at which they felt comfortable. A stopwatch was used to record the time required to reach the 10 m point that was marked in the middle of this walk. The time recorded in two trials was averaged as the walking score.

In the TUG test, participants were asked to stand up from a standard chair with a seat height of 40 cm, walk a distance of 3 m at a maximum pace, turn, walk back to the chair, and sit down. The time recorded from two trials was averaged to obtain the TUG score.

In the FR test, each participant was positioned next to a wall with one arm raised at 90° and fingers extended. A meter stick was mounted on the wall at shoulder height. The distance that a participant could reach while extending forward from an initial upright posture to the maximal anterior leaning posture without moving or lifting the feet was visually measured in centimetres according to the position of the tip of the third finger against the mounted meter stick. The distances measured in two trials were averaged to obtain the FR score.

In the OLS test, participants were instructed to start from a standing position with a comfortable base as support with eyes open and arms at their sides. They were then instructed to stand unassisted on either leg. OLS was measured in seconds from the time one foot was lifted from the floor to when it touched the ground or the standing leg.

In the SC test, participants were asked to walk along the walkway at a self-selected speed and to avoid contact with the obstacles. Participants walked along a level walkway, 10 m in length. The simple course consisted of six wooden white (contrasting the floor colour) blocks (3, 100 and 1 cm in height, length and width, respectively). These obstacles were placed across the walkway at intervals of 2 m. Time to complete each walking trial was recorded using a stopwatch. The number of obstacles contacted was recorded. The SC test was carried out only once for each participant at each time-point.

In the CC test, the field test was the same as that used for the CC exercise (Fig. 1). The complex course consisted of 16 wooden white (contrasting the floor colour) blocks (3, 100 and 1 cm in height, length and width, respectively). The test-retest reliability using the intraclass correlation coefficient was 0.935. The positions in which the flags and obstacles were placed are shown in Figure 1. The tester gave the following instruction to the participants: "Please move to number 15 as quickly and as correctly as possible while avoiding obstacles". Time to complete each walking trial was recorded using

a stopwatch. The number of obstacles contacted was recorded. The CC test was carried out only once for each participant at each time-point.

Required sample size

A previous study showed that approximately 30% of the Japanese community-dwelling adults, 65 years of age or older, fall at least once a year. This result was consistent with a previous report.² We designed the current study to detect a 30% difference in fall rate between the groups (CC group = 10% and SC group = 30%), for which a sample size of 72 per group ($\alpha = 0.05$ and power = 80%) was necessary. With an estimated dropout rate of 5%, a final sample size of 76 per group was required.

Statistical analysis

Baseline characteristics of CC and SC groups were compared to examine the comparability of the two groups. Differences in the physical function variables between the two groups were analyzed using the Student's *t*-test or χ^2 -test.

The number of falls and fall-related fractures was calculated from the beginning of the study to the participant's death, withdrawal from the trial or the end of the 12-month follow-up period. Confidence intervals (CI) for the falls and fall-related fracture rates were calculated assuming that the number of falls and fall-related fractures followed a negative binomial distribution. Incidences of falls and fall-related fractures with 95% CI were calculated for participants in the CC and SC groups, and compared using negative binomial regression analysis. Results were presented using incident rate ratios (IRR) with their 95% CI. The effect of exercise on outcome measurements was analyzed using a mixed 2 × 2 (group [CC and SC groups] × time [pre-training, post-training]) analysis of variance. Post-hoc Tukey tests were used to assess which group or time periods showed significant differences.

Data were entered and analyzed using the SPSS (Windows version 18.0, SPSS, Chicago, IL, USA). A *P*-value of <0.05 was considered statistically significant for all analyses.

Results

Overall, 207 people were screened, and 157 (75.8%) who met the inclusion criteria for the trial and agreed to participate were enrolled (Fig. 2). Of the individuals not meeting the inclusion criteria (*n* = 50), most were excluded because they had exercised regularly in the 6 months before screening. Seven people who were eligible for the study withdrew their participation after a

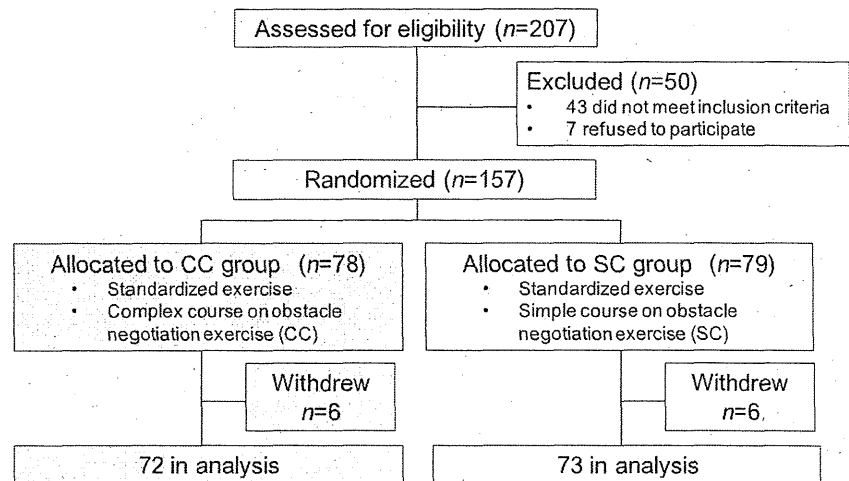

Figure 2 A flow chart showing the distribution of participants throughout the trial.

Table 1 Baseline characteristics of the study participants in complex course obstacle negotiation exercise and simple course obstacle negotiation exercise groups

Characteristic	CC group <i>n</i> = 72	SC group <i>n</i> = 73	<i>P</i>
Age (years)	85.8 ± 5.9	85.3 ± 5.7	0.71
Bodyweight, (kg)	44.9 ± 9.8	47.8 ± 9.4	0.36
Height (cm)	145.1 ± 9.0	147.8 ± 9.2	0.22
Female, <i>n</i> (%)	63 (88.7%)	64 (86.5%)	0.59
RDST (points)	7.5 ± 2.2	7.6 ± 2.5	0.80
Medication (<i>n</i>)	3.7 ± 2.9	3.8 ± 3.3	0.89
Walking aids, <i>n</i> (%)	34 (47.2%)	30 (41.1%)	0.28
Falls in the last year, <i>n</i> (%)	28 (38.9%)	29 (39.7%)	0.59

CC, complex course obstacle negotiation exercise; RDST, Rapid Dementia Screening Test; SC, simple course obstacle negotiation exercise.

telephone screening. Of the 157 individuals selected for the study, 145 (92.3%) completed the 12-month follow up: 72 in the CC group (92.3%) and 73 in the SC group (92.4%).

All 24 scheduled intervention sessions were completed. The median relative adherence was 96% (25th to 75th percentile, 88–100%) in the CC group and 96% (88–100%) in the SC group. No fall incidents occurred during training sessions or testing. No health problems, including cardiovascular or musculoskeletal complications, occurred during training sessions or testing. Minor problems observed in both groups were muscle ache after the first training sessions and fatigue. All problems were managed easily using adjustment of the intervention, and they improved during the intervention. Participants in the CC and SC groups were comparable and well matched with regard to their baseline characteristics (Table 1).

Two participants (2.8%) in the CC group and 19 (26.0%) in the SC group had experienced falls during the 12 months after the exercise program. During the 12-month follow-up period, the IRR of falls in the SC group against the CC group was 9.37 (95% CI 2.26–38.77). One participant (1.4%, distal radius *n* = 1) in the CC group and 8 (10.9%, distal radius *n* = 2; proximal humerus *n* = 3; hip *n* = 3) in the SC group experienced fall-related fractures during the 12-month follow-up period. The IRR of fall-related fractures in the SC group against the CC group was 7.89 (95% CI 1.01–61.49).

Participants in the CC group had significantly greater improvements in secondary outcome measures including the performance time and the number of obstacles contacted under the CC condition (*P* < 0.05) (Table 2). However, other secondary outcome measures were not significantly different between the two groups (*P* > 0.05).

Table 2 Functional fitness items in each group at pre- and postintervention

Item	Pre-intervention	Postintervention	Group × Time Interaction F-value	P-value
10-m walking time (s)				
CC group	16.2 ± 7.4	14.1 ± 4.4	0.01	0.91
SC group	18.6 ± 10.0	15.1 ± 6.2		
10-m walking step (<i>n</i>)				
CC group	27.5 ± 8.1	26.6 ± 7.2	1.08	0.30
SC group	31.6 ± 14.3	27.3 ± 9.9		
TUG (s)				
CC group	13.6 ± 5.2	13.7 ± 5.3	0.18	0.67
SC group	18.3 ± 9.4	14.8 ± 7.1		
Functional reach (cm)				
CC group	15.9 ± 9.3	16.1 ± 8.2	3.21	0.08
SC group	13.8 ± 7.5	14.0 ± 6.8		
One leg standing (s)				
CC group	6.0 ± 7.4	5.1 ± 5.7	2.56	0.12
SC group	3.2 ± 3.6	4.9 ± 6.1		
Performing time under simple course (s)				
CC group	15.9 ± 8.8	14.5 ± 4.0	0.28	0.60
SC group	17.2 ± 7.9	15.5 ± 5.9		
Performance time under complex course (s)				
CC group	132.6 ± 36.9	105.7 ± 18.7	5.63	0.02
SC group	152.0 ± 54.1	140.9 ± 53.8		
No. obstacles contacted under simple course (times)				
CC group	1.0 ± 1.1	0.3 ± 1.1 [†]	0.60	0.44
SC group	1.2 ± 1.4	0.2 ± 0.6 [†]		
No. obstacles contacted under complex course (times)				
CC group	1.9 ± 2.1	0.1 ± 0.4 [†]	5.62	0.02
SC group	1.7 ± 2.0	1.8 ± 2.8 [†]		

[†]As calculated by group comparison $P < 0.05$. Columns indicating pre- and postintervention values are expressed as mean (SD). CC, complex course obstacle negotiation exercise; SC, simple course obstacle negotiation exercise; TUG, timed up and go test.

Discussion

The SC exercise is an obstacle-avoidance program under simple task conditions. The CC exercise is an obstacle-avoidance program under complex task conditions, and is designed to address multiple domains, such as attention, short-term memory and balance, which when impaired have been shown to increase fall risk.²¹ The present results show that the CC program can improve the performance time of the CC test. This result is consistent with our previous study.¹⁰

In the CC program, the obstacles were organized to gradually increase the level of difficulty. Therefore, it is possible that the CC program improves the participants' performance by decreasing the number of obstacles contacted under the CC conditions. This result suggested that the obstacle-avoidance program, which increases attention demands for obstacles during

walking under complex task conditions, is useful for the improvement of obstacle-avoidance capability. Previous studies have shown that the obstacle-avoidance success rate was decreased by the presence of a secondary task.^{22,23} Furthermore, elderly individuals with a high risk for falls chose an early transfer of gaze strategy when challenged with an obstacle under dual-task conditions.¹³ The present study showed that our CC program could improve divided attention under complex task conditions.

The differences in fall and fall-related fracture rates between CC and SC groups were significant during the 12 months after the intervention. The improvement in the number of obstacles contacted and the performance time of the CC test became apparent in increased capacity in a real-life environment.

There were several limitations of the present study that warrant mention. First, the participants were

probably more motivated and showed greater interest in health and fall risk than the general population of older adults. Second, the information about the medications for osteoporosis was not included in the analysis. It is possible that such medications have an effect on the fracture incidence.

The results of this RCT suggest that the CC program is more effective in improving the number of obstacles contacted and the performance time of the CC test than the SC program. In addition, participants who received individualized obstacle-avoidance training under complex tasks combined with a traditional intervention showed a lower incidence rate of falls and fall-related fractures during the 12-month follow-up period. These results implicated the importance of population-based prevention programs to reduce falls and fall-related fractures in older adults (75 years and older). This is the first study to show that the obstacle-avoidance program, focusing on attention demands of obstacles during walking under complex task conditions, is useful in preventing falls and fall-related fractures in older adults. A larger study is needed to confirm the present results and to evaluate the most effective exercises for the prevention of falls and fall-related fractures.

Acknowledgments

The authors acknowledge Ms Kazue Hatakeyama, Ms Ai Tanahashi, Ms Masako Tanaka, Ms Makiko Ashida, Mr Minoru Ikeda, Mr Yusuke Terasaki and Mr Toyoki Yasuda for their contributions to the data collection. None of the authors have conflict of interest or financial disclosures.

Disclosure statement

The authors declare no conflict of interest.

References

- O'Loughlin JL, Robitaille Y, Boivin JF, Suissa S. Incidence of and risk factors for falls and injurious falls among the community-dwelling elderly. *Am J Epidemiol* 1993; **137**: 342–354.
- Blake AJ, Morgan K, Bendall MJ *et al*. Falls by elderly people at home: prevalence and associated factors. *Age Ageing* 1998; **17**: 365–372.
- Berg WP, Alessio HM, Mills EM, Tong C. Circumstances and consequences of falls in independent community-dwelling older adults. *Age Ageing* 1997; **26**: 261–268.
- Tinetti ME, Speechley M, Ginter SF. Risk factors for falls among elderly persons living in the community. *N Engl J Med* 1988; **319**: 1701–1707.
- Melton LJ III, Thamer M, Ray NF *et al*. Fractures attributable to osteoporosis: report from the National Osteoporosis Foundation. *J Bone Miner Res* 1997; **12**: 16–23.
- Melton LJ III, Lane AW, Cooper C, Eastell R, O'Fallon WM, Riggs BL. Prevalence and incidence of vertebral deformities. *Osteoporos Int* 1993; **3**: 113–119.
- Gillespie LD, Gillespie WJ, Robertson MC, Lamb SE, Cumming RG, Rowe BH. Interventions for preventing falls in elderly people. *Cochrane Database Syst Rev* 2009; (2): CD000340.
- Robertson MC, Campbell AJ, Gardner MM, Devlin N. Preventing injuries in older people by preventing falls: a meta-analysis of individual-level data. *J Am Geriatr Soc* 2002; **50**: 905–911.
- Beauchet O, Annweiler C, Dubost V *et al*. Stops walking when talking: a predictor of falls in older adults? *Eur J Neurol* 2009; **16**: 786–795.
- Yamada M, Tanaka B, Nagai K, Aoyama T, Ichihashi N. Trail-walking exercise and fall risk factors in community-dwelling older adults: preliminary results of a randomized controlled trial. *J Am Geriatr Soc* 2010; **58**: 1946–1951.
- Harley C, Wilkie RM, Wann JP. Stepping over obstacles: attention demands and aging. *Gait Posture* 2009; **29**: 428–432.
- Kim HD, Brunt D. The effect of a dual-task on obstacle crossing in healthy elderly and young adults. *Arch Phys Med Rehabil* 2007; **88**: 1309–1313.
- Yamada M, Tanaka H, Mori S *et al*. Fallers choose an early transfer gaze strategy during obstacle avoidance under dual-task condition. *Aging Clin Exp Res* 2011; **23**: 316–319.
- Menant JC, St George RJ, Fitzpatrick RC, Lord SR. Impaired depth perception and restricted pitch head movement increase obstacle contacts when dual-tasking in older people. *J Gerontol A Biol Sci Med Sci* 2010; **65**: 751–757.
- Kalbe E, Calabrese P, Schwalen S, Kessler J. The Rapid Dementia Screening Test (RDST): a new economical tool for detecting possible patients with dementia. *Dement Geriatr Cogn Disord* 2003; **16**: 193–199.
- Koski K, Luukinen H, Laippala P, Kivela SL. Physiological factors and medications as predictors of injurious falls by elderly people: a prospective population-based study. *Age Ageing* 1996; **25**: 29–38.
- Lopopolo RB, Greco M, Sullivan D, Craik RL, Mangione KK. Effect of therapeutic exercise on gait speed in community-dwelling elderly people: a meta-analysis. *Phys Ther* 2006; **86**: 520–540.
- Podsiadlo D, Richardson S. The timed "Up & Go": a test of basic functional mobility for frail elderly persons. *J Am Geriatr Soc* 1991; **39**: 142–148.
- Vellas BJ, Wayne SJ, Romero L, Baumgartner RN, Rubenstein LZ, Garry PJ. One-leg balance is an important predictor of injurious falls in older persons. *J Am Geriatr Soc* 1997; **45**: 735–738.
- Duncan PW, Weiner DK, Chandler J, Studenski S. Functional reach: a new-clinical measure of balance. *J Gerontol* 1990; **45**: M192–M197.
- Yamada M, Ichihashi N. Predicting the probability of falls in community-dwelling elderly individuals using the trail-walking test. *Environ Health Prev Med* 2010; **15**: 386–391.
- Chen HC, Ashton-Miller JA, Alexander NB, Schultz AB. Effects of age and available response time on ability to step over an obstacle. *J Gerontol* 1994; **49**: M227–M233.
- Weerddesteyn V, Schillings AM, van Galen GP, Duysens J. Distraction affects the performance of obstacle avoidance during walking. *J Mot Behav* 2003; **35**: 53–63.



Contents lists available at SciVerse ScienceDirect

Archives of Gerontology and Geriatrics

journal homepage: www.elsevier.com/locate/archger

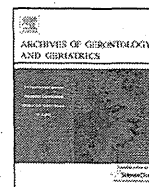

Chronic kidney disease (CKD) is an independent risk factor for long-term care insurance (LTCI) need certification among older Japanese adults: A two-year prospective cohort study

Minoru Yamada*, Hidenori Arai, Shu Nishiguchi, Yuu Kajiwara, Kazuya Yoshimura, Takuya Sonoda, Taiki Yukutake, Hiroki Kayama, Takanori Tanigawa, Tomoki Aoyama

Department of Human Health Sciences, Kyoto University Graduate School of Medicine, 53 Kawahara-cho, Shogoin, Sakyo-ku, Kyoto 606-8507, Japan

ARTICLE INFO

Article history:

Received 15 January 2013
Accepted 16 March 2013
Available online xxx

Keywords:

CKD
Risk factor
LTCI
Older adults
Japanese

ABSTRACT

CKD is associated with impairments in health status, physical function, and frailty. The aim of the current prospective cohort study was to determine whether CKD predicted new LTCI need certification among community-dwelling older Japanese adults. This was a prospective cohort study. We analyzed the cohort data from a prospective study, The Japan Multicenter Aging Cohort for Care Prevention (J-MACC). We followed 8063 elderly adults for 2 years, and we analyzed the relationship between CKD and LTCI need. The outcome studied was new certification for LTCI service need during a 2-year period. We measured serum creatinine (the estimated glomerular filtration rate; eGFR), serum albumin, frailty checklist scores, and body mass index. During the 2-year follow-up, 536 subjects (6.6%) were newly certified as needing LTCI services. We stratified the cohort according to eGFR quartile and performed multivariate analyses using an eGFR value of 71.4–83.6 ml/min/1.73 m² as a reference. We found that subjects with eGFR values <60.0 ml/min/1.73 m² had a significantly elevated risk of LTCI service need (adjusted hazard ratio: 1.44 [95% CI 1.12–1.86]). Our results indicate that CKD is independently associated with new LTCI service need certification and is an important marker of frailty in older adults.

© 2013 Elsevier Ireland Ltd. All rights reserved.

1. Introduction

Frailty in older adults is a serious problem in countries with aging populations, such as Japan. In general, frailty is defined as a vulnerable state that places older adults at high risk of adverse health outcomes, such as falls, hospitalization, and mortality (Wiswell et al., 2001).

Age is a major risk factor for CKD, which is a growing health problem in Japan. The prevalence of CKD in the adult Japanese population is estimated to be 13% (Imai et al., 2009). In addition, the number of patients with end-stage renal disease (ESRD) has increased by approximately 7% per year in Japan (Akiba et al., 2000). CKD is associated with impairments in health status and physical function, as well as frailty (Brogan, Haber, & Kutner, 2000; Kurella et al., 2004; Kurella, Yaffe, Shlipak, Wenger, & Chertow, 2005). CKD is also associated with oxidative stress, chronic inflammation, insulin resistance, vascular calcification, and osteoporosis (Ensrud et al., 2007; Landau et al., 2011; Shanahan, 2005). Furthermore, a decreased creatinine clearance <60 ml/min/

1.73 m² has been shown to predict incident falls among community-dwelling older women (Gallagher, Rapuri, & Smith, 2007). Thus, CKD poses a considerable medical and public health challenge, particularly in the older population.

Japan implemented a LTCI system in April 2000 to help manage a rapidly aging population. Prior to 2000, long-term care services were provided under a tax-based social welfare system for seniors with limited economic resources and family support (Campbell & Ikegami, 2000). However, since the implementation of LTCI, the services of this program have been provided to elderly adults who are certified as requiring support or care according to their care needs and certification assessment (Tsutsui & Muramatsu, 2005).

The aim of the current prospective cohort study, therefore, was to determine whether CKD was a risk factor for LTCI need among community-dwelling older Japanese adults.

2. Methods

2.1. Subjects

We analyzed the cohort data from a prospective study entitled J-MACC. This cohort study investigated the factors associated with LTCI need in community-dwelling Japanese

* Corresponding author. Tel.: +81 75 751 3964; fax: +81 75 751 3909.
- E-mail address: yamada@hs.med.kyoto-u.ac.jp (M. Yamada).