

cutoff value for the screening in Japan is being studied. The cutoff value of a 15 % 10-year probability is used for women and men younger than 75 years old, because almost all of the persons of this age group have a value above 15 % and thus its power as a cutoff value is too weak.

Evaluation of response to treatment

The optimal method for bone mass measurement to evaluate the therapeutic effect is DXA at the lumbar vertebrae on the anteroposterior direction, because it is sensitive enough to detect changes in bone mass. If the bone mass cannot be measured precisely at the lumbar vertebrae, measurement at the total hip is recommended. The timing of measurement should be determined based on the least significant change of each method.

The efficacy of drugs with significant effects on bone metabolism can be evaluated by measuring bone metabolic markers. It is beneficial to measure bone resorption markers at 3 to 6 months after the initiation of treatment and bone formation markers every 6 to 12 months. Attention should be paid to the minimum significant change of each marker.

Plain radiography is useful for detection of incident vertebral fractures after the initiation of treatment. CT, MRI, and bone scintigraphy are sometimes required for confirmation of minor fractures, incomplete fractures, and unapparent fractures, and for differentiation from other clinical conditions including tumors.

QOL assessment using the Japanese Osteoporosis Quality of Life Questionnaire (JOQOL) is useful also for evaluation of therapeutic effects.

Basic treatments (non-pharmacological treatment)

A daily intake of calcium (700 to 800 mg) is recommended to optimize the effect of pharmacological treatment. It has been reported that calcium derivatives and calcium supplements may increase the risk of cardiovascular diseases. However, dietary intake of the same amount of calcium has not been shown to increase cardiovascular risk. Moreover, those adverse findings were reported from outside Japan, where calcium intake, serum lipid levels, and BMI are different from those in Japan. At this time, calcium as a medicine or supplement should not exceed 500 mg per dose.

Vitamin D (recommended daily intake, 10 to 20 μ g) and vitamin K (250 to 300 μ g) are also essential, and they should be prescribed to be taken as a medicine when it is difficult for the patient to obtain a sufficient amount from dietary sources. Hyperhomocysteinemia due to vitamin deficiency (vitamins B₆, B₁₂, and folic acid) involved in homocysteine metabolism has been shown to be a BMD-independent risk factor for fracture. It is recommended to warn patients not to consume excessive amounts of phosphorus, salt content, caffeine, and alcohol.

It has been demonstrated that high-impact activities, resistance exercises, back muscle exercises, stretching exercises, aerobic exercises, walking, and balance training can increase BMD and prevent vertebral fractures and falls in patients with osteoporosis.

In terms of pain relief, few data from randomized controlled trials are available about the effects of various physical therapies, nerve blocks, and surgeries; however, the efficacy of some drugs has been demonstrated.

Pharmacological treatment

These Guidelines detail the effect of each therapeutic agent used in Japan on BMD and the risk of vertebral fracture, non-vertebral fracture, and proximal femoral fracture, based on evidence from Japan and abroad. Each recommendation is also graded (Table 1). In regard to some therapeutic agents, the effect on QOL is also described. Table 2 shows the prescription drugs covered by the public health insurance in Japan.

For the selection of therapeutic agents, the full range of drug-related information must be considered: the efficacy of each medicine on BMD, fracture risk, QOL including pain, bone metabolic markers, risk of fall, as well as safety, including effects other than those on bone metabolism per se and adverse effects. Further, the patient's clinical state must be considered.

The systematic review published by MacLean and colleagues indicated that bisphosphonates (alendronate and risedronate) are a first-line agent for patients at high risk of vertebral, non-vertebral, or proximal femoral fracture [9]. Parathyroid hormone derivatives are first-line agents for patients at high risk of vertebral or non-vertebral fracture. Selective estrogen receptor modulators (SERMs) are first-line agents for patients at high risk of vertebral fracture. Minodronic acid, a bisphosphonate developed in Japan, is expected to be used for the high-risk group for vertebral fracture. Eldecacitol, an active vitamin D₃ derivative developed in Japan, is expected to be used for the high-risk group for vertebral or non-vertebral fracture. However, more data are required for these new agents.

Estrogen derivatives

A postmenopausal decrease in bone mass is caused by estrogen deficiency. Therefore, estrogen replacement has been considered to be an effective treatment option for osteoporosis since early times. Estrogen replacement is useful also for prevention and treatment of other diseases and symptoms caused by estrogen deficiency. Administration of estrogen to young amenorrhic women or relatively young postmenopausal women can prevent osteoporosis. Estrogen is also useful for treatment of osteoporosis in women with climacteric symptoms in relatively early stage of postmenopause. Conjugated estrogen, estradiol, and estriol are the approved estrogen derivatives in Japan.

Table 1 Grading of recommendation of therapeutic agents for osteoporosis in Japan

Therapeutic agent		BMD	Vertebral fracture	Non-vertebral fracture	Proximal femoral fracture
Calcium	Calcium L-aspartate hydrate	C	C	C	C
	Dibasic calcium phosphate hydrate	C	C	C	C
Estrogen	Estriol	C	C	C	C
	Conjugated estrogens ^a	A	A	A	A
	Estradiol	A	C	C	C
Active vitamin D ₃	Alfacalcidol	B	B	B	C
	Calcitriol	B	B	B	C
	Eldecalcitol	A	A	B	C
Vitamin K ₂	Menatetrenone	B	B	B	C
Bisphosphonate	Etidronate disodium	A	B	C	C
	Alendronate sodium hydrate	A	A	A	A
	Sodium risedronate hydrate	A	A	A	A
	Minodronic acid hydrate	A	A	C	C
SERM	Raloxifene hydrochloride	A	A	B	C
	Bazedoxifene acetate	A	A	B	C
Calcitonin ^b	Elcatonin	B	B	C	C
	Calcitonin (Salmon)	B	B	C	C
PTH	Teriparatide (genetical recombination)	A	A	A	C
Other drugs	Ipriflavone	C	C	C	C
	Nandrolone decanoate	C	C	C	C

A strongly recommended to use, B recommended to use, C not enough evidence to recommend use, D recommended not to use

^a Administration of conjugated estrogen for osteoporosis is not covered by the public health insurance in Japan

^b Calcitonin has an analgesic effect, and reduces pain due to osteoporosis (grade A)

Table 2 Prescriptions of anti-osteoporotic agents covered by the public health insurance in Japan (as of September 2011)

Generic name	Launched	Prescription for osteoporosis
Calcium L-aspartate hydrate	1968	1.2 mg/day, p.o.
Dibasic calcium phosphate hydrate	1985	3 g/day, p.o.
Estriol	1969	1 mg/day, p.o.
Conjugated estrogens	1999	Not covered by the public insurance
Estradiol	2008	1 mg/day, p.o.
Alfacalcidol ^a	1981	0.5 or 1 µg/day, p.o. (adult)
Calcitriol	1986	0.5 µg/day, p.o.
Eldecalcitol ^a	2011	0.75 or 0.5 µg/day, p.o.
Menatetrenone ^a	1995	45 mg/day, p.o.
Etidronate disodium	1990	200 or 400 mg/day, p.o. (intermittent)
Alendronate sodium hydrate	2001	5 mg/day or 35 mg/w, p.o.
Sodium risedronate hydrate	2002	2.5 mg/day or 17.5 mg/w, p.o.
Minodronic acid hydrate ^a	2009	1 mg/day or 50 mg/4w, p.o.
Raloxifene hydrochloride	2004	60 mg/day, p.o.
Bazedoxifene acetate	2010	20 mg/day, p.o.
Elcatonin ^a	1982	20 IU/w, i.m.
Calcitonin (Salmon)	1990	20 IU/w, i.m.
Teriparatide (genetical recombination)	2010	24 µg/day, s.c. (up to 24 months)
Ipriflavone	1988	200 mg/day, p.o.
Nandrolone decanoate	1984	25 or 50 mg/3 w, i.m.

^aAgents developed in Japan

Although conjugated estrogen increases BMD and prevents vertebral, non-vertebral, and proximal femoral fracture, it is not covered by the public health insurance in Japan for the treatment of osteoporosis.

Estradiol increases BMD, but there is little evidence that it prevents fractures.

There is almost no evidence about the effects of estriol.

Alfacalcidol and calcitriol (active vitamin D₃ derivatives)

Alfacalcidol and calcitriol are active vitamin D₃ derivatives. Alfacalcidol, developed in Japan, is a prodrug requiring hydroxylation in the liver for activation. Because these derivatives were approved for the treatment of osteoporosis in 1983 and 1989, respectively, there is insufficient large clinical trial data. However, several reports suggested these agents maintain lumbar BMD at a significantly higher level as compared to placebo, or reduce the risk of vertebral and non-vertebral fractures (not statistically significant; Fig. 9a) [10].

It has been reported also that vitamin D deficiency causes atrophy of the type II muscle fibers, and that vitamin D supplementation improves trunk imbalance. Active vitamin D₃ derivatives (alfacalcidol and calcitriol) reduce falls among the elderly (Fig. 9b) [11]. These active vitamin D₃ derivatives have been confirmed to be safe, even for long-term use, and they are recommended for the elderly (see "Combination therapy" for combination with bisphosphonate).

Eldecalcitol (active vitamin D₃ derivative)

Although the conventional active vitamin D₃ derivatives have been reported to be effective for preventing fractures, they have not been shown to increase BMD significantly. Various vitamin D₃ derivatives have been investigated; of these eldecalcitol was developed in Japan. Eldecalcitol showed superior efficacy to alfacalcidol to increase BMD (Fig. 10a) [12], while its effect on calcium absorption was nearly unchanged. Eldecalcitol may exert its actions by

a

	Source (Year)	RR	95% CI
Standard Vit. D	Baeksgaard L (1998)	0.33	0.10–1.25
Hydroxylated Vit. D	◇ Gallagher JC (1990)	0.90	0.82–1.20
	◆ Orimo H (1994)	0.37	0.55–2.02
	◇ Ott SM (1989)	1.46	0.59–3.62
	◇ Tilyard MW (1992)	0.43	0.31–0.81
	◆ Geusens P (1986)	0.88	0.43–1.80
	◇ Orimo H (1987)	0.46	0.31–0.89
	◆ Caniggia A (1984)	0.20	0.01–3.51
	Pooled hydroxylated Vit. D	0.64	0.44–0.92
Pooled estimate		0.63	0.45–0.88

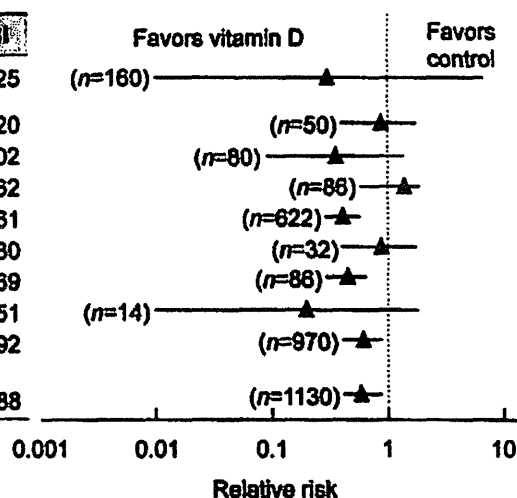

b

Source (Year)	Vitamin D	OR	95% CI
Pfeifer M (2000)	Natural type	0.47	0.20–1.10
Bischoff-Ferrari HA (2003)	Natural type	0.68	0.30–1.54
Gallagher JC (2001)	Active type	0.53	0.32–0.88
Dukas L (2004)	Active type	0.69	0.41–1.16
Graafmans WC (1996)	Natural type	0.91	0.59–1.40
Pooled (Uncorrected)		0.69	0.53–0.88

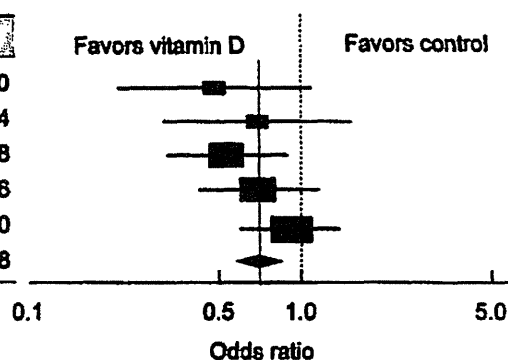

Fig. 9 Meta-analyses on the efficacy of vitamin D. **a** Relative risk for vertebral fractures after treatment with vitamin D. *RR* relative risk, *CI* confidence interval. *Open rhombus* indicates using calcitriol and *closed rhombus* using alfacalcidol. Adapted from Papadimitropoulos

[10] (Copyright© 2002 The Endocrine Society). **b** Compared risk of falling between vitamin D-treated group and control group. *OR* odds ratio, *CI* confidence interval. Adapted from Bischoff-Ferrari [11] (Copyright© 2004 American Medical Association)

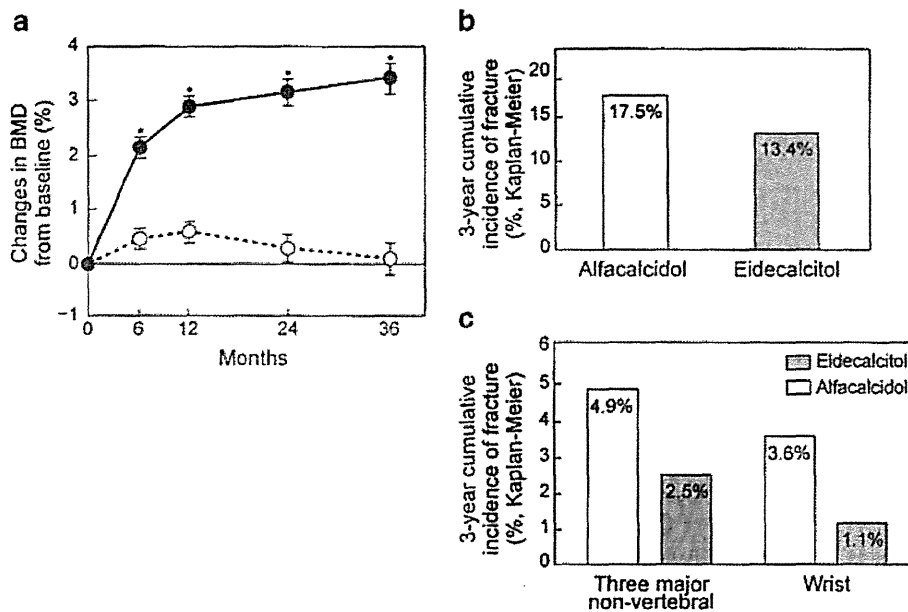

Fig. 10 Effect of eldecalcitol compared with alfacalcidol. **a** Change in lumbar BMD. Data are mean \pm SE, * $p < 0.001$ vs alfacalcidol group by Student *t* test (Matsumoto [12] (Copyright© 2011 Elsevier)). **b** Incidence of vertebral fracture. Hazard ratio (HR) is 0.74 and 95 % confidence interval (CI) is 0.56–0.97. Data from Matsumoto [12] (Copyright© 2011 Elsevier). **c** Incidence of non-vertebral fractures. HR for three major non-

vertebral fractures is 0.52 and 95 % CI is 0.29–0.93, $p = 0.031$. Three major non-vertebral sites mean humerus, wrist, and hip, i.e., the three sites of major non-vertebral fractures recognized as osteoporotic fractures in FRAX[®]. HR for wrist fractures is 0.29 and 95 % CI is 0.11–0.77, $p = 0.005$. Data from Matsumoto [12] (Copyright© 2011 Elsevier) and the website of Pharmaceuticals and Medical Devices Agency (in Japanese)

promoting calcium absorption from the small intestine, similar to the conventional active vitamin D₃ derivatives, and prevent bone resorption by inhibiting osteoclastic function.

In a comparative study of eldecalcitol and alfacalcidol, the incidence of vertebral fractures was found to be significantly lower in the eldecalcitol group (Fig. 10b) [12]. While there was no significant difference in the overall incidence of non-vertebral fractures between the eldecalcitol and alfacalcidol groups, there was a trend towards a greater decrease in the incidence of non-vertebral fractures at the three major sites (humerus, wrist, and hip) in the eldecalcitol group than in the alfacalcidol group (Fig. 10c) [12]. Of note, the incidence of wrist fractures was significantly reduced in the eldecalcitol group.

Clinical trials of eldecalcitol have been conducted in patients over a wide range of age and severity, and this agent can be used across the entire spectrum of patients with osteoporosis.

Menatetrenone (vitamin K₂ derivative)

In elderly women and patients with osteoporosis being treated with a bisphosphonate, insufficient intake of vitamin K is a BMD-independent risk factor for fractures. Menatetrenone, a vitamin K₂ derivative, promotes carboxylation of osteocalcin, and thereby it reduces the serum level of ucOC, an index of vitamin K deficiency.

Menatetrenone slightly increases lumbar BMD and reduces vertebral and non-vertebral fractures (Fig. 11)

[13]. Menatetrenone is considered to exert its fracture-reducing effect via a mechanism of action other than increasing BMD.

Etidronate (bisphosphonate)

Notably, for etidronate, a first-generation bisphosphonate, there is a small margin between its serum level for the onset of its inhibitory actions on bone resorption and the serum level for its inhibitory effects on bone formation. Close attention must be paid to its narrow safety range. Thus, a cyclical intermittent treatment strategy (200 to 400 mg/day once daily for 2 weeks, followed by a rest period of 10 to 12 weeks) is essential.

Because etidronate reduces bone resorption, it is effective particularly for high-turnover osteoporosis, and it maintains bone mass even in low-turnover osteoporosis. Etidronate reduces blood and urine levels of bone metabolic markers. Etidronate reduces incident vertebral fractures in patients who have vertebral fractures. There is no clear evidence about whether or not etidronate reduces non-vertebral fractures.

Alendronate (bisphosphonate)

Alendronate, a second-generation bisphosphonate, has a very wide safety range. Its inhibitory effect on bone resorption is exerted at a much smaller dose than the dose for its inhibitory effect on bone formation (approximately 1/6,000).

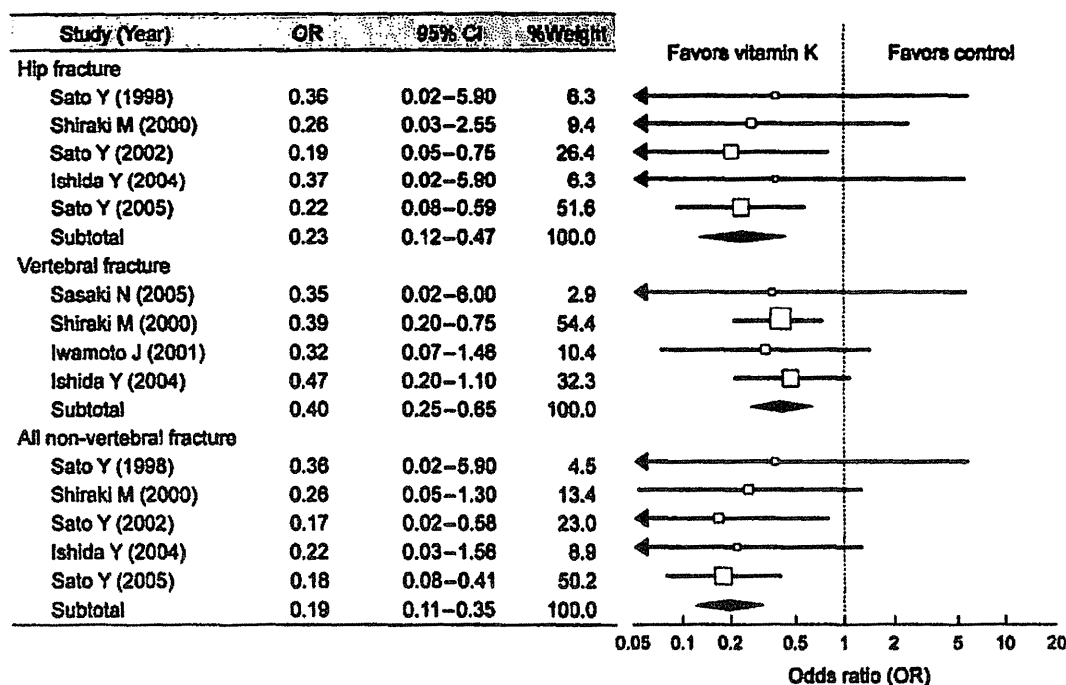

Fig. 11 Meta-analysis on the efficacy of menatetrenone on fractures. OR odds ratio, CI confidence interval (Cockayne [13] (Copyright© 2006 American Medical Association))

Many clinical trials and meta-analyses have shown that alendronate increases BMD, reduces fractures at the vertebra/non-vertebra, proximal femur, and distal end of the forearm; and improves the bone metabolic marker profile. Alendronate has been reported to reduce vertebral fracture and increase lumbar BMD also in men with osteoporosis.

In terms of QOL, a decrease in the duration of bed rest for low back pain, a decrease in the days of activity restriction, and improvement of arthralgia and pain-related QOL scores after treatment with alendronate have been reported (see “Combination therapy” for the combination with active vitamin D₃ derivatives).

A once-weekly dose of alendronate (35 mg), compared to a daily dose of alendronate (5 mg) was shown to have a similar effect on lumbar BMD and urinary levels of type I collagen cross-linked N-telopeptides (NTX); the incidence of adverse reactions and drug discontinuation was lower in the once-weekly group.

Risedronate (bisphosphonate)

Risedronate, a third-generation bisphosphonate, has a strong inhibitory effect on bone resorption.

Many clinical trials and meta-analyses have shown that risedronate increases BMD and reduces fractures at the vertebra/non-vertebra and proximal femur in postmenopausal women. Risedronate was reported to increase lumbar BMD also in men with osteoporosis. Large-scale clinical

trials in North America, Europe, and Australia have shown preventive effects with risedronate against incident vertebral fracture from the first year of treatment. In Japan, it was reported that risedronate improved scores for body pain, vitality, and social functioning in QOL assessment using the SF-36 scale.

Once-weekly risedronate (35 mg), compared to daily risedronate (5 mg), was shown to increase BMD at the femoral neck and trochanter to the same degree in a study in the USA. In a Japanese clinical trial, once-weekly risedronate (17.5 mg), compared to daily risedronate (2.5 mg), increased lumbar BMD to the same degree at 48 weeks.

Minodronic acid (bisphosphonate)

Minodronic acid is the only domestically developed bisphosphonate for osteoporosis, and the only bisphosphonate which has been investigated for its inhibitory effect on fracture in Japanese patients at doses approved in Japan. Minodronic acid has the strongest inhibitory effect on bone resorption among the bisphosphonates currently available in Japan.

The efficacy of minodronic acid on BMD at the lumbar spine and total hip is equivalent to alendronate (Fig. 12a) [14]. In addition, minodronic acid significantly increased BMD in patients who had a poor response to other bisphosphonates.

Minodronic acid reduced vertebral fracture risk by 59% in Japanese patients with osteoporosis (Fig. 12b) [15], and no

Fig. 12 Effect of minodronic acid on BMD and vertebral fracture. **a** Percent change in lumbar spine and total hip BMD. *Solid line* is minodronic acid 1 mg ($n=134$) and *broken line* is alendronate 5 mg ($n=135$). Data are mean \pm SE (Hagino [14] (Copyright© 2009 Elsevier)). **b** Incidence of vertebral fracture. *Solid line* is minodronic acid ($n=339$) and *broken line* is placebo ($n=328$). Relative risk is 0.411 (95% confidence interval 0.267–0.634) by Cox regression model. * $p<0.0001$ by log-rank test between the groups (Matsumoto [15] (Copyright© 2009 Springer Science + Business Media BV))

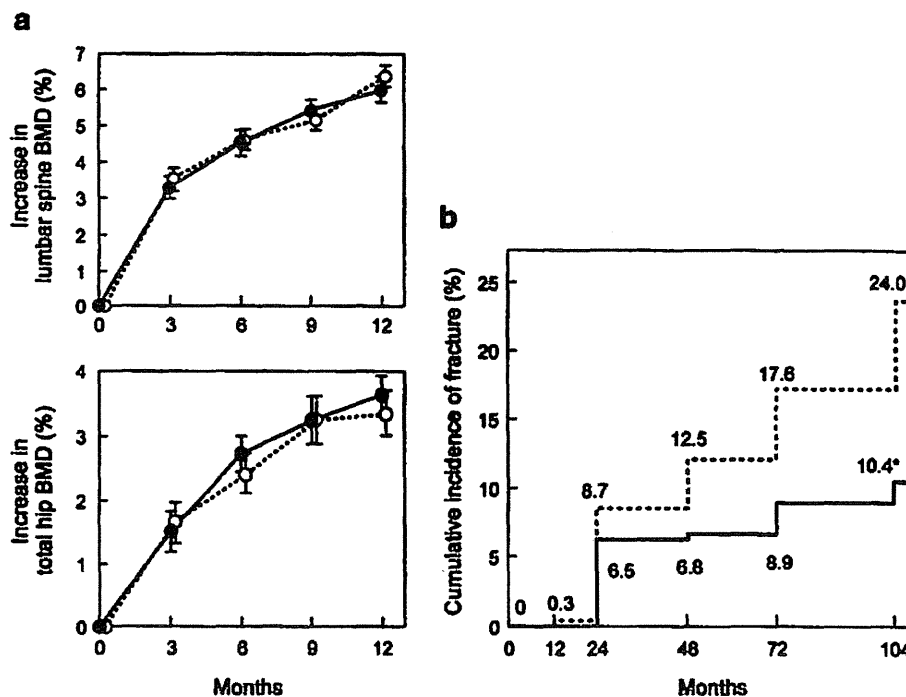

difference was observed in the effect between patients above and below 75 years of age. No clinical trial to determine the effect of minodronic acid on non-vertebral fracture or proximal femoral fracture has been conducted. The results of the ongoing Japanese Osteoporosis Intervention Trial (JOINT)-04 initiated in 2011 by the Adequate Treatment of Osteoporosis (A-TOP) Research Group (see “Combination therapy”) are greatly anticipated to answer these questions. Minodronic acid is available for daily use (1 mg) and once every 4 weeks (50 mg).

Raloxifene (SERM)

Raloxifene, a selective estrogen receptor modulator, binds to the estrogen receptor (ER) with an affinity equivalent to estrogen and induces a conformational change at the helix 12 in the C-terminal part of ER; this conformational change produced by raloxifene is different from that produced by estrogen. Thus, raloxifene has a tissue-selective pharmacological action: it shows estrogen-like effects on bone, but not on the breast or uterus.

The Multiple Outcomes of Raloxifene Evaluation, a large-scale randomized controlled trial with 7,705 patients in 25 countries, demonstrated that raloxifene increased BMD and reduced incident vertebral fractures, regardless of the presence or absence of prevalent vertebral fractures and even in subjects with low bone mass (osteopenia). Additionally, raloxifene significantly reduced the incidence of non-vertebral fractures in patients with severe vertebral fractures. In Japan, a 3-year post-marketing surveillance

demonstrated that the overall incidence of clinical fractures was as low as 1.2 %.

Many observational studies from Japan and abroad demonstrated the effect of raloxifene on QOL, including pain relief. A meta-analysis revealed that raloxifene decreases the overall mortality by 10 %.

Venous thromboembolism is one of the clinically important adverse events of SERMs. The incidence of venous thromboembolism in patients treated with raloxifene is 0.2 %, stated in the drug package insert, based on the results of a 3-year post-marketing surveillance conducted in 7,557 Japanese patients.

Bazedoxifene (SERM)

Bazedoxifene, a SERM, has an estrogen-like action selectively on bone metabolism and lipid metabolism, but not on the breast or uterus.

An international multi-center clinical trial demonstrated that bazedoxifene increases BMD and reduces vertebral fractures, similar to raloxifene. Although no overall reduction on non-vertebral fractures was observed with bazedoxifene, the incidence of non-vertebral fracture in postmenopausal women at a higher risk of fracture was significantly reduced by bazedoxifene as compared to placebo and raloxifene. Additionally, the higher the FRAX® score, the more effectively bazedoxifene reduced osteoporotic fractures. Bazedoxifene was also reported to improve the profile of bone metabolic markers. The effect of bazedoxifene on proximal femoral fracture has not been studied yet.

A significant decrease in the incidence of vertebral fractures and the safety of the drug were consistently observed during the 5-year treatment with bazedoxifene.

Calcitonin derivatives

Calcitonin is a bone resorption inhibitor acting directly on osteoclasts and pre-osteoclasts to control their functions. Calcitonin also relieves pain via the central serotonergic system, and therefore its derivatives may be the first choice to obtain pain relief and improves QOL in the early phase after the occurrence of osteoporotic fractures or in patients with postural distortion associated with vertebral fractures.

There are some reports on the effect of calcitonin derivatives on BMD and vertebral fracture (Fig. 13a) [16], but none on non-vertebral or proximal femoral fractures.

Some randomized clinical trials and systematic reviews revealed significant reductions in the severity of pain associated with ADLs 1 to 4 weeks after calcitonin was started (Fig. 13b) [17]. In terms of QOL, improvement in SF-36 scores, pain relief, and improved ADLs, and an enhanced effect of rehabilitation in patients who had a total hip replacement after proximal femoral fracture was reported.

Outside of Japan, intra-nasal formulations of calcitonin derivatives are used primarily, and a preventive effect on fractures and beneficial effect on pain was observed. However, the increased risk of cancer was reported from the European Medical Association (EMA) in patients treated with calcitonin and intra-nasal calcitonin was withdrawn from the European market.

Although antibodies might be produced after injection of calcitonin derivatives, they do not influence the effect of

calcitonin and are not involved in the side effects of calcitonin derivatives. Therefore, patient monitoring is not needed.

Teriparatide (recombinant human parathyroid hormone)

Unlike bone-resorption inhibitors, intermittent administration of teriparatide (a recombinant form) as a daily subcutaneous injection specifically increases serum P1NP, a bone formation marker, indicating promotion of bone remodeling followed by the formation of bone tissue.

Teriparatide, given as a daily subcutaneous injection, is recommended in patients at high risk of fractures such as patients who have had a fracture(s) while being treated with a bisphosphonate or SERM, elderly patients with multiple vertebral fractures or proximal femoral fractures, or patients with significantly reduced BMD. The combination of teriparatide with an oral bisphosphonate is not recommended.

Teriparatide increases BMD at the lumbar vertebrae and proximal femur, and reduces vertebral and non-vertebral fracture. The incidence of a radial fracture is reduced with teriparatide, while the apparent BMD of the radius is slightly decreased in association with the formation of new bone matrix, and the external diameter of the radius is increased. A meta-analysis revealed that teriparatide reduces low back pain.

Teriparatide (a recombinant form) approved in Japan is self-injected daily at home, after instruction by physicians or nurses. The total dosing period is limited to 24 months. After 24 months of treatment with teriparatide, adequate treatment with a bone-resorption inhibitor is recommended to maintain the bone strength.

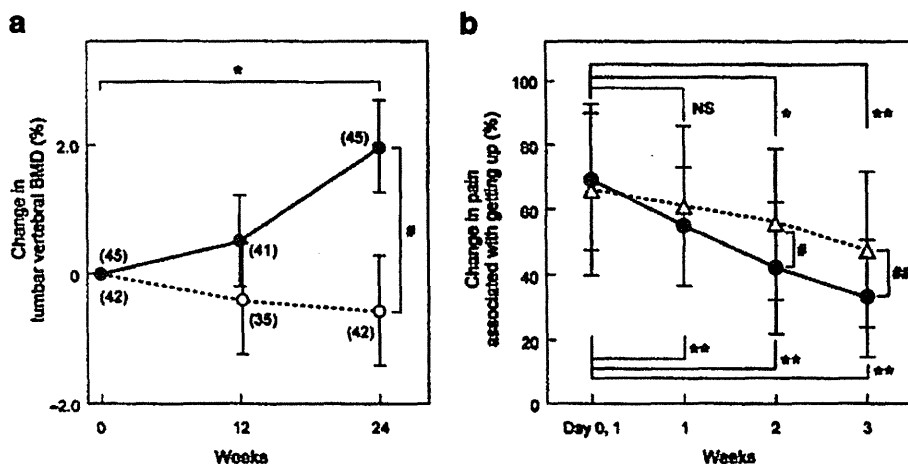

Fig. 13 Effect of elcatonin on BMD and pain associated with vertebral fracture. **a** Percent change in lumbar spine BMD. *Solid line* is elcatonin (20 units per week) with 0.6 g calcium lactate and *broken line* is control (calcium lactate only). Data are mean \pm SE. Numerals in parentheses denote number of patients. Comparison within groups: Student's paired *t*-test, # p <0.05; between groups: Student's unpaired *t*-test, * p <0.05.

Orimo H [16] (Copyright© 1996 Springer Science + Business Media BV). **b** Percent change in pain associated with getting up evaluated with visual analog scale (VAS). *Solid line* is elcatonin (20 units per week, $n=44$) and *broken line* is control (untreated, $n=42$). Two-way repeated-measures ANOVA, * p <0.05, ** p <0.01, NS not significant. Mann-Whitney *U* test, # p <0.05, ## p <0.01 (Nakano [17])

Combination therapy

Osteoporosis is a multifactorial disease, thus combination therapy with agents with different mechanisms of action is considered reasonable. However, the efficacy of combination therapy lacks evidence at this time.

The Adequate Treatment of Osteoporosis (A-TOP) Research Group was authorized in the year 2000 by the Japan Society of Osteoporosis and assisted by the Public Health Research Foundation to obtain clinical evidence regarding osteoporosis treatment. It conducted a clinical trial comparing monotherapy with alendronate, a new bisphosphonate at the time, and combination therapy with alendronate and alfacalcidol, an active vitamin D₃ derivative developed in Japan (Japanese Osteoporosis Intervention Trial: JOINT-02). The incidence of vertebral fracture was significantly reduced in the combination therapy group during the first 6 months of treatment, and in both subgroups of patients with multiple vertebral fractures and grade 3 vertebral fractures by semiquantitative assessment during the 2-year treatment period (Fig. 14) [18]. The incidence of non-vertebral fracture (weight-bearing bones) was also significantly reduced in the combination therapy group. Based on these results, combination therapy with alendronate and an active vitamin D₃ derivative is recommended for the prevention of incident vertebral and non-vertebral fracture in patients at a high risk of fracture.

Secondary osteoporosis

Osteoporosis secondary to other diseases

Secondary osteoporosis is defined as decreased BMD and deteriorated bone quality (pathologic state specific to osteoporosis) having one or more causes in addition to genetic

factors, lifestyle, menopause, and aging. Secondary osteoporosis that is caused by a disease, such as hyperparathyroidism, can be improved by treating the underlying disease.

Hyperparathyroidism can be classified into either primary hyperparathyroidism, a disorder of the parathyroid itself, or secondary hyperparathyroidism, a pathological state secondary to other disorders, such as chronic kidney disease or vitamin D deficiency/depletion. In both types of hyperparathyroidism, excessively secreted parathyroid hormone promotes bone turnover and consequently decreases the BMD, resulting in an increased fracture risk. However, the therapeutic strategies employed for each type are entirely different. Primary hyperparathyroidism is treated mainly by parathyroidectomy, and there is no evidence regarding pharmacologic treatment. Secondary hyperparathyroidism improves with treatment of its underlying disease. Hyperparathyroidism secondary to CKD should be treated in accordance with the Japanese Evidence-based Practice Guideline for the Treatment of CKD.

In rheumatoid arthritis, bone resorption increases and BMD decreases because of several factors, including activation of inflammatory cytokines, immobility, and use of glucocorticoids. Consequently, the fracture risk increases. Infliximab, an anti-TNF agent used to treat rheumatoid arthritis, increases BMD in patients with osteoporosis secondary to rheumatoid arthritis. Among the useful therapeutic medications for osteoporosis, bisphosphonates reduce fracture risk.

Osteoporosis secondary to lifestyle-related diseases

In recent years, it was demonstrated that bone metabolism is influenced by some atherosclerosis-inducing disorders such as diabetes mellitus, dyslipidemia, hypertension, and chronic kidney disease. In particular, osteoporosis caused by diabetes mellitus or CKD is established as "osteoporosis secondary to

Fig. 14 Efficacy of combination therapy with alendronate and active vitamin D₃ on vertebral fracture. HR hazard ratio of incident vertebral fracture, CI confidence interval (Orimo [18] (Copyright© 2011 Informa Plc.))

Factors	n	HR	95% CI	p value	
All randomized	2016	0.89	0.64–1.25	0.51	
Age (years)	<75	805	0.67	0.47–1.63	0.67
	75 ≤ <80	662	1.19	0.67–2.13	0.54
	80 ≤	549	0.66	0.38–1.16	0.15
25(OH)vitamin D (ng/mL)	<20	435	1.02	0.47–2.24	0.96
	20 ≤	1426	0.84	0.57–1.23	0.36
Number of prevalent vertebral fracture	0	805	1.73	0.65–3.65	0.13
	1	626	1.28	0.66–2.47	0.48
	2 ≤	585	0.51	0.32–0.84	0.01
Maximum grade of prevalent vertebral fracture	0	805	1.74	0.85–3.55	0.13
	1	391	1.04	0.33–3.21	0.96
	2	395	0.89	0.48–1.71	0.72
	3	425	0.55	0.36–0.84	0.03

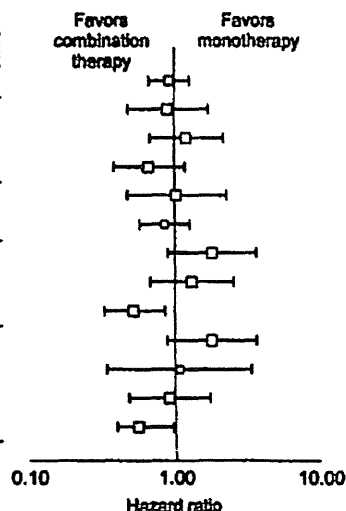

lifestyle-related diseases”, bringing it special attention within secondary osteoporosis. A vigorous assessment for osteoporosis is recommended in patients with these diseases.

Osteoporosis secondary to lifestyle-related diseases is mainly associated with deterioration in bone quality, whereas BMD is relatively well-preserved in most cases. Therefore, therapeutic intervention in patients with diabetes mellitus or CKD should be started as soon as “decreased bone mass” is identified, in accordance with the diagnostic criteria of osteoporosis.

The main cause of deterioration in bone quality in these patients is thought to be altered cross-links among the collagen molecules in bone tissue (nonphysiological collagen cross-links, i.e., advanced glycation endproducts) due to an increase in oxidative stress and acceleration of glycation.

While the therapeutic modality has not been established yet, the benefit of alendronate, risedronate, raloxifene, and parathyroid hormone derivatives has been reported in large clinical trials. Pentosidine is likely to be a marker for bone quality and is expected to be an index of the fracture risk.

Treatment-related osteoporosis

Glucocorticoid agents and sex hormone lowering therapy are important causes of treatment-related osteoporosis.

Systemically administrated glucocorticoid decreases bone mass and increases fracture risk, thus 50 % of patients under long-term treatment with glucocorticoids suffer from osteoporosis. In general, patients taking glucocorticoids at doses of 5 mg (prednisolone equivalent) or more per day for 3 months or more should be assessed for bone mass and the need for osteoporosis treatment. Moreover, it is recommended to start treatment at higher BMD values than those used in the criteria for treatment of primary osteoporosis. In Japan, a revision of the 2004 “Guidelines on the management and treatment of corticosteroid-induced osteoporosis” is being developed.

Even though guidelines currently recommend bisphosphonates for the treatment of glucocorticoid-induced osteoporosis, generally they are not recommended for women intending to become pregnant. Although teriparatide is expected to increase bone mass, it is indicated only for “osteoporosis with a high risk of fractures”.

Endocrine therapy (sex hormone lowering therapy) for breast cancer and prostate cancer decreases BMD. Bisphosphonates can improve BMD in these patients, but there is no evidence yet about its ability to reduce fracture risk.

Open Access This article is distributed under the terms of the Creative Commons Attribution Noncommercial License which permits any noncommercial use, distribution, and reproduction in any medium, provided the original author(s) and the source are credited.

Conflicts of interest None.

References

1. Yoshimura N, Muraki S, Oka H et al (2009) Prevalence of knee osteoarthritis, lumbar spondylosis, and osteoporosis in Japanese men and women: the research on osteoarthritis/osteoporosis against disability study. *J Bone Miner Metab* 27:620–628
2. Orimo H, Yaegashi Y, Onoda T et al (2009) Hip fracture incidence in Japan: estimates of new patients in 2007 and 20-year trends. *Arch Osteoporos* 4:71–77
3. Yoshimura N, Kinoshita H, Oka H et al (2006) Cumulative incidence and changes in prevalence of vertebral fractures in a rural Japanese community: a 10-year follow-up of the Miyama cohort. *Arch Osteoporos*. doi:10.1007/s11657-006-0007-0
4. Orimo H, Hayashi Y, Fukunaga M et al (2001) Diagnostic criteria for primary osteoporosis: year 2000 revision. *J Bone Miner Metab* 19:331–337
5. You K (2011) *Osteoporos Jpn* 19:626, in Japanese
6. Nishizawa Y, Ohta H, Miura M, et al. Guidelines for the use of bone metabolic markers in the diagnosis and treatment of osteoporosis (2012 Edition). *J Bone Miner Metab*. doi:10.1007/s00774-012-0392-y
7. Orito S, Kuroda T, Onoe Y et al (2009) Age-related distribution of bone and skeletal parameters in 1322 Japanese young women. *J Bone Miner Metab* 27:698–704
8. Orimo H, Hosoi T, Fukunaga M (eds) (2009) Manual for osteoporosis screening and health guidance. Life Science Publishing, Tokyo, in Japanese
9. MacLean C, Newberry S, Maglione M et al (2008) Systematic review: comparative effectiveness of treatments to prevent fractures in men and women with low bone density or osteoporosis. *Ann Intern Med* 148:197–213
10. Papadimitropoulos E, Wells G, Shea B et al (2002) Meta-analysis of the efficacy of vitamin D treatment in preventing osteoporosis in postmenopausal women. *Endocr Rev* 23:560–569
11. Bischoff-Ferrari HA, Dawson-Hughes B, Willett WC et al (2004) Effect of vitamin D on falls: a meta-analysis. *JAMA* 291:1999–2006
12. Matsumoto T, Ito M, Hayashi Y et al (2011) A new active vitamin D₃ analog, eldcalcitol, prevents the risk of osteoporotic fractures: a randomized, active comparator, double-blind study. *Bone* 49:605–612
13. Cockayne S, Adamson J, Lanham-New S et al (2009) Vitamin K and the prevention of fractures: systematic review and meta-analysis of randomized controlled trials. *Arch Intern Med* 166:1256–1261
14. Hagino H, Nishizawa Y, Sone T et al (2009) A double-blinded head-to-head trial of minodronate and alendronate in women with postmenopausal osteoporosis. *Bone* 44:1078–1084
15. Matsumoto T, Hagino H, Shiraki M et al (2009) Effect of daily oral minodronate on vertebral fractures in Japanese postmenopausal women with established osteoporosis: a randomized placebo-controlled double-blind study. *Osteoporos Int* 20:1429–1437
16. Orimo H, Morii H, Inoue T et al (1996) Effect of elcatonin on involutional osteoporosis. *J Bone Miner Metab* 14:73–78
17. Nakano T (2011) Clinical effect of calcitonin (elcatonin) on acute pain for osteoporotic vertebral fracture: semi blind randomized controlled trial. *Osteoporos Jpn* 19:279
18. Orimo H, Nakamura T, Fukunaga M et al (2011) Effects of alendronate plus alfacalcidol in osteoporosis patients with a high risk of fracture: the Japanese Osteoporosis Intervention Trial (JOINT)-02. *Curr Med Res Opin* 27:1273–1284

PubMed

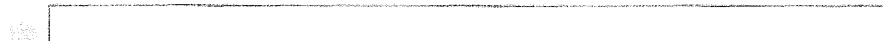

Display Settings: Abstract



Osteoporos Int. 2012 Jul 17. [Epub ahead of print]

Risk factors associated with the occurrence of hip fracture in Japanese patients with rheumatoid arthritis: a prospective observational cohort study.

Furuya T, Inoue E, Hosoi T, Taniguchi A, Momohara S, Yamanaka H.

Institute of Rheumatology, Tokyo Women's Medical University, 10-22 Kawada-cho, Shinjuku-ku, Tokyo, 162-0054, Japan, furuyat@ior.twmu.ac.jp.

Abstract

Risk factors associated with the occurrence of hip fracture in Japanese patients with rheumatoid arthritis (RA) were evaluated in a prospective, observational cohort study. Physical disability, advanced age, history of total knee replacement (TKR), and low body mass index (BMI) appear to be associated with the occurrence of hip fracture.

INTRODUCTION: This study seeks to evaluate the association between potential risk factors and the occurrence of hip fractures in Japanese RA patients.

METHODS: A total of 9,720 patients (82.1 % female; mean age, 55.7 years) with RA were enrolled in a prospective observational study from 2000 to 2010. Self-reported hip fractures were verified using patient medical records. Cox proportional hazards models were used to analyze independent contributions of various risk factors to hip fracture occurrence.

RESULTS: During a mean follow-up of 5.2 years, 152 patients reported 152 hip fractures. Among these patients, 97 hip fractures in 97 patients (15 males, 82 females) were verified with medical records. Japanese version of the Health Assessment Questionnaire (J-HAQ) disability score [per 1 score, hazard ratio (HR), 2.64; 95 % confidence interval (CI), 1.94-3.58], age (per 10 years; HR, 1.53; 95 % CI, 1.25-1.87), history of TKR (HR, 3.75; 95 % CI, 1.57-8.96), and BMI (per 1 kg/m²), HR, 0.92; 95 % CI, 0.86-0.99) were significantly associated with hip fractures. Among the scores on the eight domains of the J-HAQ, J-HAQ (arising) (HR, 1.74; 95 % CI, 1.28-2.36) and J-HAQ (hygiene) (HR, 1.58; 95 % CI, 1.11-2.24) were significantly correlated with the occurrence of hip fracture.

CONCLUSIONS: High J-HAQ disability score, advanced age, history of TKR, and low BMI appear to be associated with the occurrence of hip fractures in Japanese RA patients. Among the eight domains of the J-HAQ, arising and hygiene disabilities appear to be correlated with the occurrence of hip fractures in this patient population.

PMID:22801953[PubMed - as supplied by publisher]

[LinkOut - more resources](#)

Association of *CYP19* Gene Polymorphism with Vertebral Fractures in Japanese Postmenopausal Women

Yasuko Koudu · Tsuneko Onouchi · Takayuki Hosoi · Toshiyuki Horiuchi

Received: 18 March 2011 / Accepted: 17 November 2011 / Published online: 9 December 2011
© Springer Science+Business Media, LLC 2011

Abstract This study investigates aromatase gene polymorphism, which might influence bone strength in terms of mineral density and quality. We explored the relationship between *CYP19* polymorphisms and vertebral fractures in postmenopausal Japanese women. In addition, we compared estrogen and testosterone levels in Japanese postmenopausal women with and without fractures. Osteoporotic postmenopausal women showed higher incidences of vertebral fractures than osteopenic women or women with normal lumbar bone mineral density (L2-4 BMD). Estrogen concentrations in postmenopausal women were associated with BMD; however, no association was found between sex hormone levels and the presence of fractures. The C allele rs2470152 was significantly associated with increased risk of vertebral fractures ($P = 0.04$), whereas none of the *CYP19* polymorphisms showed differences in sex steroid levels between subjects with and without fractures. Allelic variants of aromatase genes appear to interact to influence the risk of vertebral fractures in postmenopausal Japanese women.

Keywords Aromatase gene polymorphisms · Vertebral fractures · Postmenopausal women

Y. Koudu · T. Horiuchi (✉)
Department of Endocrinology and Metabolism, Tokyo Metropolitan Toshima Hospital,
33-1 Sakaecho Itabashiku, Tokyo 173-0015, Japan
e-mail: t-horiuchi@toshima-hp.jp

T. Onouchi
Department of Collaborative Research, Teikyo University School of Medicine, Tokyo, Japan

T. Hosoi
Department of Advanced Medicine, National Center of Geriatrics and Gerontology, Obu, Japan

Introduction

Osteoporosis is caused by multiple factors, including environmental factors (such as calcium intake), exercise, and estrogen levels. The main source of estrogen in postmenopausal women is the aromatization of androgenic precursors, a reaction catalyzed by the cytochrome P450 (CYP) aromatase enzyme, encoded by *CYP19* located on chromosome 15q21.1. It has recently been reported that estrogen levels are genetically determined by aromatase activity (Olson et al. 2007; Haiman et al. 2007; Sowers et al. 2006). In addition, allelic variants of the aromatase gene have been associated with bone mineral density (BMD) and bone fractures (Hong et al. 2007; Masi et al. 2001; Somner et al. 2004). A/G polymorphisms in the 3' untranslated region (UTR) and the I.2 promoter (rs10046 and rs1062033; Rinancho et al. 2005) and an A/G polymorphism in the I.6 promoter rs4775936 (Enjuanes et al. 2006) of the aromatase gene have been studied in relation to osteoporosis and BMD, but the results remain controversial. In addition, an rs2470152 polymorphism in the aromatase gene has been shown to affect serum estrogen levels in Swedish men (Eriksson et al. 2009). Therefore, in order to analyze the association with the risk of vertebral fractures in postmenopausal women, we conducted a cross-sectional study of the interaction between *CYP19* gene polymorphisms and sex steroid hormone levels or risk of vertebral fractures in Japanese postmenopausal women. In this study, we focused on four markers (rs2470152, rs4775936, rs1062033, and rs10046) to clarify the association between polymorphisms in aromatase genes and vertebral fractures.

Materials and Methods

Study Subjects

Three hundred sets of genomic DNA and serum samples were provided from the collected samples of the Institute of Medical Sciences, Tokyo University, obtained for tailor-made medicine realization projects. These samples were collected from the various institutions that were members of these projects following the approval of the individual ethics committees. Ethical approval was obtained from the Ethics Committee of the Leading Project for Personalized Medicine in the Institute of Medical Science, University of Tokyo, and the Tokyo Metropolitan Geriatric Hospital. Another 300 DNA samples were collected from women for the purpose of analyzing the relationship between polymorphisms and the etiology of disease in the Japanese population. The samples were provided by the Leading Project for Personalized Medicine of the Ministry of Education, Culture, Sports, Science and Technology, Japan.

The samples were divided into three categories according to the *T* score of the measurement of lumbar spine BMD (L2-4 BMD) by dual energy X-ray absorptiometry (DXA) as defined by the World Health Organization: *T* scores of -1.0 and above were classified as normal BMD, scores of -2.5 to -1.0 were considered osteopenia, and scores below -2.5 were considered osteoporotic.

For assessment of vertebral fractures, anteroposterior and lateral X-ray examinations of the thoracic and lumbar spine were performed. Morphometrically,

a vertebral fracture was defined in terms of the ratio of the anterior height of vertebral body to the posterior height (below 0.75) or the ratio of the center height to the anterior or posterior height (below 0.8). In all cases, the vertebral fractures were evaluated by two groups of radiologists and geriatricians in each institute.

Sex Steroid Assay

The serum levels of testosterone (*T*) and estradiol (*E*₂) were measured by mass spectrophotometry (LC–MS/MS). Bioavailable testosterone and estrogen, which includes the free form and the albumin-binding form, were measured by LC–MS/MS (Arai et al. 2010). Serum samples were stored at -70°C until analyzed. For statistical analysis, the values were transformed into logarithmic form, since the values are exponential and the distributions of *T* and *E*₂ levels were skewed using the raw data.

Genotype Analysis

We examined four polymorphisms of *CYP19*: rs1062033, a G/C SNP located at around exon 1.2 (at position chromosome 15, 49335230); rs10046, a T/C SNP located in the 3' UTR (at position chr.15, 49290276); rs4775936, a C/T SNP located in the vicinity of exon 1.6 (at position chr.15, 49323314); and rs2470152, a T/C SNP located in intron 1 (at position chr.15, 49382254). These SNPs were identified by searching the National Center for Biotechnology Information (NCBI) database because they are analyzable by the readily available TaqMan assays used for disease association studies (Applied Biosystems). Polymorphisms in genomic DNA were measured by the TaqMan assay. Age, body mass index, and years since menopause were examined in three SNP genotypes among four *CYP19* markers.

Statistical Analyses

Chi-square analysis was used to compare the numbers of osteoporosis, osteopenia, and normal patients by *T* scores of L2-4 BMD with and without fractures. Similarly, each parameter was compared among the three genotypes in four *CYP19* markers using ANOVA. The correlation between estradiol levels and L2-4 BMD was shown using Pearson's coefficients. The associations between aromatase gene polymorphisms and vertebral fracture risk were compared by Chi-square analysis using SPSS software.

Results

Bone Density Data

There were significantly more women with fractures than without among patients with osteoporosis ($T < -2.5$; $P < 0.05$), and there was no significant increase in fractures among normal patients or those with osteopenia. There were no differences

in the log estradiol (Log E_2) or log testosterone (Log T) values between women with fractures and those without fractures (Table 1).

Relationship Between L2-4 BMD and Estrogen level

Log E_2 levels in postmenopausal women were significantly associated with L2-4 BMD ($r = 0.21$, $p = 0.03$; Fig. 1), whereas log T levels showed no association (data not shown).

Genotype Analysis

When we examined the correlation between the four polymorphisms (rs2470152, rs1062033, rs4775963, and rs10046) and vertebral fractures in postmenopausal women, we found a significant correlation for rs2470152 ($P = 0.04$) but not for the

Table 1 Bone mineral density of postmenopausal women with and without fractures

T score ^a & sex steroids	Women without fractures (137)	Women with fractures (138)	P
$T < -2.5$	18	37	0.015
$-2.5 \leq T < 1.0$	12	13	NS
$-1.0 \leq T$	4	5	NS
Log E_2 (pg/ml)	0.335 ± 0.383	0.327 ± 0.330	NS
Log T (ng/dl)	2.033 ± 0.367	2.067 ± 0.247	NS

^a Bone mineral density was measured in 89 of the 275 subjects

NS not significant

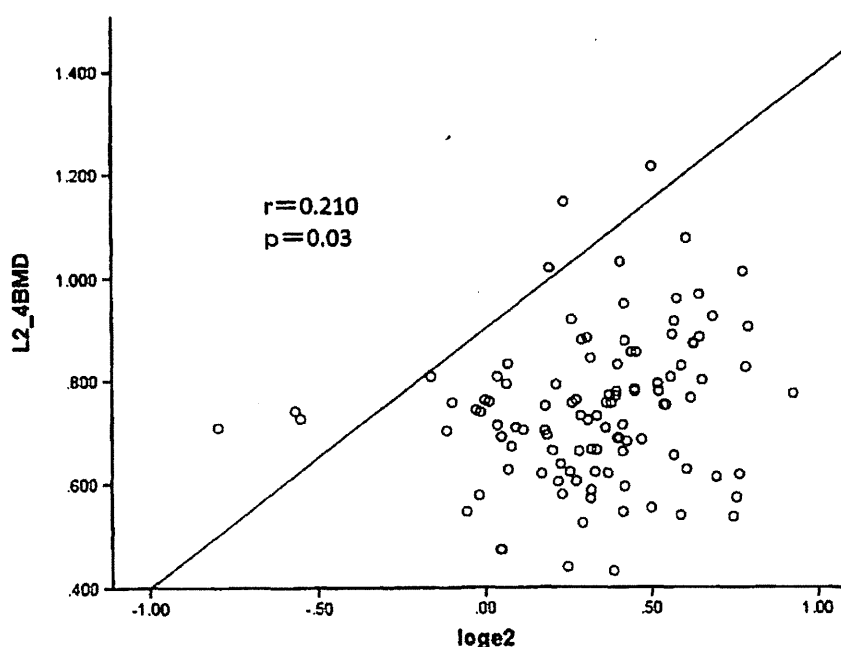

Fig. 1 Correlation between log E_2 and L2-4 BMD in postmenopausal women. Estrogen levels were significantly correlated with L2-4 BMD ($r = 0.21$, $p = 0.03$)

Table 2 Correlation of four *CYP19* SNPs with vertebral fractures

SNP	Genotype	Premenopause		<i>P</i>	Postmenopause		<i>P</i>
		Control (<i>n</i> = 19)	Case (<i>n</i> = 6)		Control (<i>n</i> = 136)	Case (<i>n</i> = 138)	
rs2470152	CC	9	1	0.408	44	47	0.040 ^a
	TC	8	4		56	71	
	TT	2	1		36	20	
rs4775936	CC	5	1	0.712	48	59	0.416
	CT	9	4		68	59	
	TT	5	1		20	20	
rs1062033	CC	4	1	0.693	47	56	0.507
	CG	9	4		64	62	
	GG	6	1		25	20	
rs10046	TT	7	1	0.550	31	26	0.324
	TC	8	4		67	62	
	CC	4	1		38	50	

^a Only rs2470152 polymorphisms of the aromatase gene showed a significant correlation with vertebral fractures (*P* = 0.04)

Table 3 Characteristics of postmenopausal Japanese women and three SNPs of rs2470152

Characteristic	Genotype			<i>P</i>
	CC	CT	TT	
Age (years)	72.8 ± 9.3	73.6 ± 8.3	74.3 ± 6.8	NS
Body mass index (kg/m ²)	22.4 ± 4.6	21.8 ± 4.5	21.1 ± 4.3	NS
Years since menopause	24.2 ± 9.5	24.3 ± 10.3	25.4 ± 11.6	NS
Log <i>E</i> ₂ (pg/ml)	0.302 ± 0.319	0.330 ± 0.280	0.307 ± 0.357	NS
Log <i>T</i> (ng/dl)	2.001 ± 0.347	2.067 ± 0.269	2.050 ± 0.313	NS
L2-4BMD (110)	0.753 ± 0.135	0.739 ± 0.157	0.729 ± 0.118	NS
LT score (89)	-2.6 ± 1.2	-2.6 ± 1.3	-3.3 ± 0.8	NS

NS not significant

other three polymorphisms (Table 2). There were no differences in age, body mass index, or years since menopause among the three SNP types in the four *CYP19* markers (Table 3).

Discussion

We examined the relationship between aromatase-related genes and vertebral fractures by analyzing *CYP19* gene polymorphisms in Japanese women. Among four markers, no differences were found in serum *T* and *E*₂ concentrations in the Japanese postmenopausal women. It is possible that local *E*₂ concentrations are

more important in local tissues rather than serum levels. Bone cells are able to express aromatase and other enzymes required for estrogen synthesis locally (Janssen et al. 1999; Shouzu and Simpson 1998; Watanabe et al. 2004), and aromatase activity in cultured osteoblasts is quantitatively similar to that in adipose stromal cells (Shouzu and Simpson 1998). Thus, estrogen synthesized in bone cells might be important in postmenopausal bone metabolism.

Eriksson et al. (2009) found that genetic variants of rs2470152 in aromatase are associated with E_2 levels, showing that G alleles were correlated with higher serum E_2 levels and BMD in Swedish men than other alleles. Our results, however, showed that the C allele of rs2470152 is associated with vertebral fractures, a finding that suggests that ethnicity, race, and sex differences might influence the results of SNP studies in osteoporosis. The SNP rs2470152 is located in the region of the I.4 promoter (Bulun and Simpson 1994), and it is interesting that the G→A transition of rs2470152 is likely to alter a potential binding site for the binding protein of the transcription factor cAMP response element. The major reason for the discrepancy between our results and those of the Swedish study may be gender differences. The Swedish study focused only on male cohorts. We could not detect any disequilibrium between rs2470152 and the other three markers viewed in HapMap.

CYP19 SNPs (rs10046) were found to be associated with differences in E_2 levels in the European Prospective Investigation of Cancer-Norfolk (EPIC-Norfolk) cohort study (Dunning et al. 2004). SNP rs10046 explains 1.6% of the variance in the $E_2:T$ ratio; however, this SNP is not associated with breast cancer risk (Dunning et al. 2004). The rs10046, a T/C SNP located in the 3' UTR, 19 nucleotides downstream from the translation terminus, has been reported to be associated with increased levels of aromatase mRNA expression in tumors (Gruber et al. 2002). In our study, rs10046 was correlated with neither serum E_2 levels nor vertebral fractures. The *CYP19* genotypes demonstrated higher mRNA levels at the rs1062033 locus in postmenopausal osteoporosis. *CYP19* is regulated in a different manner and in different tissues by a hormonally controlled promoter or adipose stromal cell promoter (Mahendroo et al. 1993; Harada et al. 1993). Genetic polymorphisms of *CYP19* might be involved in other processes, such as mRNA stabilization, transcription enhancement, or the post-translational regulation of expression. Neither SNP 1062033 nor rs4775936 was significantly correlated with either serum E_2 levels or vertebral fractures.

We could not detect lower levels of bioavailable serum E_2 by LC-MS/MS in rs2470152; however, another group has shown differences in E_2 levels as measured by RIA according to *CYP19* genotype in a study that included both premenopausal and postmenopausal women (Somner et al. 2004). The discrepancy between the two studies seems to be due to the assay systems used. Bioavailable estrogen levels in postmenopausal women are more relevant than total estrogen levels, which include E_2 bound by sex hormone-binding globulin (SHBG), for bone metabolism. Despite the absence of differences in estrogen levels among the various genotypes, we found that vertebral fracture rates are associated with the *CYP19* genotype in postmenopausal Japanese women in this study. There is much evidence for the role of aromatase activity in bone homeostasis (Miyaura et al. 2001; Oz et al. 2000), and, as previously described, the pharmacological inhibition of aromatase is also associated

with a decrease in BMD and increased risk of fractures (Eastell and Hannon 2005). This indicates that aromatase in local tissues plays roles, both physiologically and pathologically, in bone metabolism.

In conclusion, we provide statistical evidence that the C allele in rs2470152 of the *CYP19* gene is associated with an increased risk of vertebral fractures in postmenopausal Japanese women. Further studies are necessary to detect functional SNPs that induce differences in bone metabolism. Furthermore, we need more participants to detect differences in E_2 levels based on the *CYP19* SNPs of aromatase genes.

Acknowledgment This work was supported by the Japanese Osteoporotic Foundation with funds donated by Eli Lilly, Japan, in 2008.

References

- Arai S, Miyashiro Y, Shibata Y, Kashiwagi B, Tomaru Y, Kobayashi M, Watanabe Y, Honma S, Suzuki K (2010) New quantification method for estradiol in the prostatic tissues of benign prostatic hyperplasia using liquid chromatography–tandem mass spectrometry. *Steroids* 75:13–19
- Bulun SE, Simpson ER (1994) Competitive reverse transcription polymerase chain reaction analysis indicates that levels of aromatase cytochrome P450 transcripts in adipose tissue of buttocks, thigh and abdomen of women increase with advantage age. *J Clin Endocrinol Metab* 78:428–432
- Dunning AM, Dowsett M, Healey CS, Tee L, Luben NL, Folkard E, Novik KL, Kelemen L, Ogata S, Pharoah PDP, Easton DF, Day NE, Ponder BAJ (2004) Polymorphism associated with circulating sex hormone levels in postmenopausal women. *J Natl Cancer Inst* 96:936–945
- Eastell R, Hannon R (2005) Long-term effects of aromatase inhibitors on bone. *J Steroid Biochem Mol Biol* 95:151–154
- Enjuanes A, Garcia-Giralt N, Supervia A, Nogues X, Ruiz-Gaspas S, Bustamante M, Mellibovsky L, Grinverg D, Balcells S, Diez-Perez A (2006) A new SNP in a negative regulatory region of the *CYP19A1* gene is associated with lumbar spine BMD in postmenopausal women. *Bone* 38:738–743
- Eriksson AL, Lorentzon M, Vandenput L, Labrie F, Linderson M, Syvanen A, Orwoll ES, Cummings SR, Zmuda JM, Ljunggren O, Karlsson MK, Mellstrom D, Ohlsson C (2009) Genetic variations in sex steroid-related genes as predictors of serum estrogen levels in men. *J Clin Endocrinol Metab* 94:1033–1041
- Gruber CJ, Tschugguel W, Schneeberger C, Huber JC (2002) Mechanisms of disease: production and actions of estrogens. *N Engl J Med* 346:340–352
- Haiman CH, Dossus L, Setiawan VW, Stram DO, Dunning AM, Thomas G, Thun MJ, Albanes D, Altshuler D, Ardanaz E, Boeing H, Buring J, Burt N, Calle EE, Chanock S, Clavel-Chapelon F, Colditz GA, Cox DG, Freigelson HS, Hankinson SE, Hayes RB, Henderson BE, Hirshhorn JN, Hoover R, Hunter DJ, Kaaks R, Kolonel LN, Marchand LL, Lenner P, Lund E, Panico S, Peeters PH, Pike MC, Riboli E, Tjonnelland A, Travis R, Trichopoulos D, Wacholder S, Ziegler (2007) Genetic variation at the *CYP19A1* locus predicts circulating estrogen levels but not breast cancer risk in postmenopausal women. *67:1893-1897*
- Harada N, Utsumi T, Takagi Y (1993) Tissue-specific expression of the human aromatase cytochrome P-450 gene by alternative use of multiple exons 1 and promoters, and switching of tissue-specific exons 1 in carcinogenesis. *Proc Natl Acad Sci USA* 90:11312–11316
- Hong X, Hsu Y, Terwedow H, Arguelles LM, Tang G, Liu X, Zhang S, Xu X (2007) *CYP19A1* polymorphisms are associated with bone mineral density in Chinese men. *Hum Genet* 121:491–500
- Janssen JMMF, Bland R, Hewison M, Coughtrie MWH, Sharp S, Arts J, Pols HAP, van Leeuwen JPTM (1999) Estradiol formation by human osteoblasts via multiple pathways: Relation with osteoblast function. *J Cell Biochem* 75:528–537
- Mahendroo MS, Mendelson CR, Simpson ER (1993) Tissue-specific and hormonally controlled alternative promoters regulate aromatase cytochrome P450 gene expression in human adipose tissue. *J Biol Chem* 268:19463–19470

- Masi L, Becherini L, Gennari L, Amedei A, Colli E, Falchetti A, Farci M, Silvestri S, Gonnelli S, Brandi ML (2001) Polymorphism of the aromatase gene in postmenopausal Italian women: distribution and correlation with bone mass and fracture risk. *J Clin Endocrinol Metab* 86:2263–2269
- Miyaura C, Toda K, Inada M, Ohshiba T, Matsumoto C, Okada T, Ito M, Shizuta Y, Ito A (2001) Sex and age-related response to aromatase deficiency in bone. *Biochem Biophys Res Commun* 280:1062–1068
- Olson SH, Bandera EV, Orlow I (2007) Variants in estrogen biosynthesis genes, sex steroid hormone levels, and endometrial cancer: a HuGE review. *Am J Epidemiol* 165:235–245
- Oz OK, Zerwekh JE, Fisher C, Graves K, Nanu L, Millsaps R, Simpson ER (2000) Bone has a sexually dimorphic response to aromatase deficiency. *J Bone Miner Res* 15:507–514
- Rinancho JA, Zarrabeitia MT, Valero C, Sanudo C, Hernandez JL, Amado JA, Zarabeitia A, Gonzalez-Macias J (2005) Aromatase gene and osteoporosis relationship of ten polymorphic loci with bone mineral density. *Bone* 36:917–925
- Shouzu M, Simpson ER (1998) Aromatase expression of human osteoblast-like cells. *Mol Cell Endocrinol* 139:117–129
- Somner J, McLellan S, Cheung J, Mak YT, Frost ML, Knapp KM, Wierzbicki AS, Wheeler M, Fogelman I, Ralston SH, Hampson GN (2004) Polymorphisms in the P450c17 (17-hydroxylase/17, 20-Lyase) and P450 c19 (aromatase) genes: association with serum sex steroid concentrations and bone mineral density in postmenopausal women. *J Clin Endocrinol Metab* 89:344–351
- Sowers MR, Wilson AL, Kardia SR, Chu J, Ferrell R (2006) Aromatase gene (*CYP19*) polymorphisms and endogenous androgen concentrations in a multiracial/multiethnic, multisite study of women at midlife. *Am J Med* 119:S23–S30
- Watanabe M, Simpson ER, Pathirage N, Nakajin S, Clyne CD (2004) Aromatase expression in the human fetal osteoblastic cell line SV-HFO. *J Mol Endocrinol* 32:533–545



全国的データベースを用いた
骨粗鬆症性骨折の予防と治療に関する研究

細井孝之 黒田龍彦 中村利孝 白木正孝 太田博明
原田 敦 森 聖二郎 大橋靖雄 折茂 肇

 ライフサイエンス出版

TEL (03) 3664-7900 (代表)

【禁 無断転載・複製】

全国的データベースを用いた 骨粗鬆症性骨折の予防と治療に関する研究

細井孝之¹⁾ 黒田龍彦²⁾ 中村利孝³⁾ 白木正孝⁴⁾ 太田博明⁵⁾
原田 敦⁶⁾ 森 聖二郎⁷⁾ 大橋靖雄⁸⁾ 折茂 肇⁹⁾

1 研究の背景

高齢者における骨折は疼痛や変形によって日常生活活動度 (ADL) を低下させ、生活の質 (QOL) を悪化させる、いわゆる「寝たきり」の主要な原因のひとつである。さらに、高齢者の骨折は生命予後にも影響を与える重大な疾患である。高齢者の骨折で頻度の高いものとして、椎体骨折、前腕骨遠位端骨折、上腕近位部骨折、大腿骨近位部骨折などがあげられるが、これらを予防するためには、骨粗鬆症対策が欠かせない。骨粗鬆症は「骨強度の低下を特徴とし、骨折のリスクが増大しやすくなる骨格疾患」と定義され¹⁾、脆弱性骨折は本疾患の合併症として位置付けられる。

骨粗鬆症診療に関する全国的データの収集・解析を行うことにより、実際の診療現場での診断や治療の成果を解析することが欠かせない。このことを通じて、既存ガイドラインの客観的評価に役立つことも期待される。現在 1500～1600 億円ともいわれている骨粗鬆症治療薬に対する医療費の適正化に資する臨床研究は、社会的ニーズに即したものと考えられる。さらに骨折に関連する医療・介護費としては、薬剤費以外にも腰痛に対する外来・入院治療費、手術関連の医療費、リハビリテーションの費用、さらに長期療養にかかる費用も考えなければならず、これらの総額は 1 兆円にもものぼることが推定されている。また、骨折や転倒予防に対する

介入は全身の健康づくりにも寄与するものであることを考え合わせると、日常診療に基づくデータベースを用いた研究は骨折予防の総合的対策立案に重要な情報をもたらし、国民の保健・医療・福祉の全般的な向上にも結びつくことが期待される。

世界保健機構 (WHO) が作成した fracture risk assessment tool (FRAX[®]) は、前向き 10 年間の骨折発生確率 (主要骨粗鬆症性骨折と大腿骨近位部骨折について) を算定するツールである²⁾。これは地域住民に関する疫学データをもとに作成されたものであり、その臨床的意義を検証する研究が求められている。

2 研究目的

本研究では日常の骨粗鬆症診療におけるデータを全国規模で収集し、骨粗鬆症性骨折の発症要因、骨粗鬆症治療薬の選択に及ぼす因子、骨粗鬆症の薬物治療による骨折予防効果などについて検討することを目的とする。

3 研究計画・方法

1) 研究の概要

平成 18 年から 20 年の厚生科学研究長寿科学総合研究で構築された骨粗鬆症診療の全国的データベースを用いる³⁾。データベース研究は前向きコホート研究であり、原発性骨粗鬆症または骨量減少の女性を対象とする。2 年おき経過情報

¹⁾ 国立長寿医療研究センター臨床研究推進部, ²⁾ パブリックヘルスリサーチセンター, ³⁾ 産業医科大学整形外科, ⁴⁾ 成人病診療研究所, ⁵⁾ 国際医療福祉大学, ⁶⁾ 国立長寿医療研究センター, ⁷⁾ 東京都健康長寿医療センター, ⁸⁾ 東京大学公共健康科学, ⁹⁾ 公益財団法人骨粗鬆症財団; 研究協力者は論文末に記載