

(図 2: Clinical_annotation (ISO25720 GSNML より))

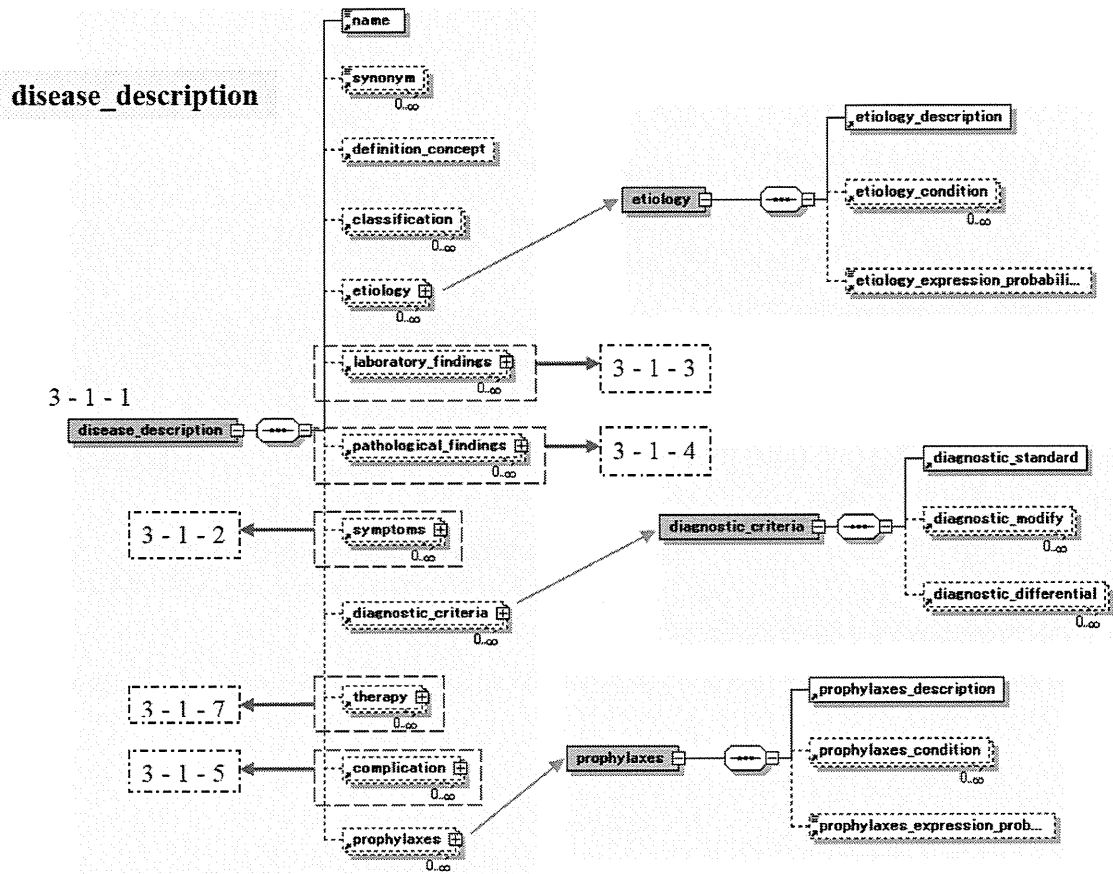

(図 3: Disease_description (ISO25720 GSVML より))

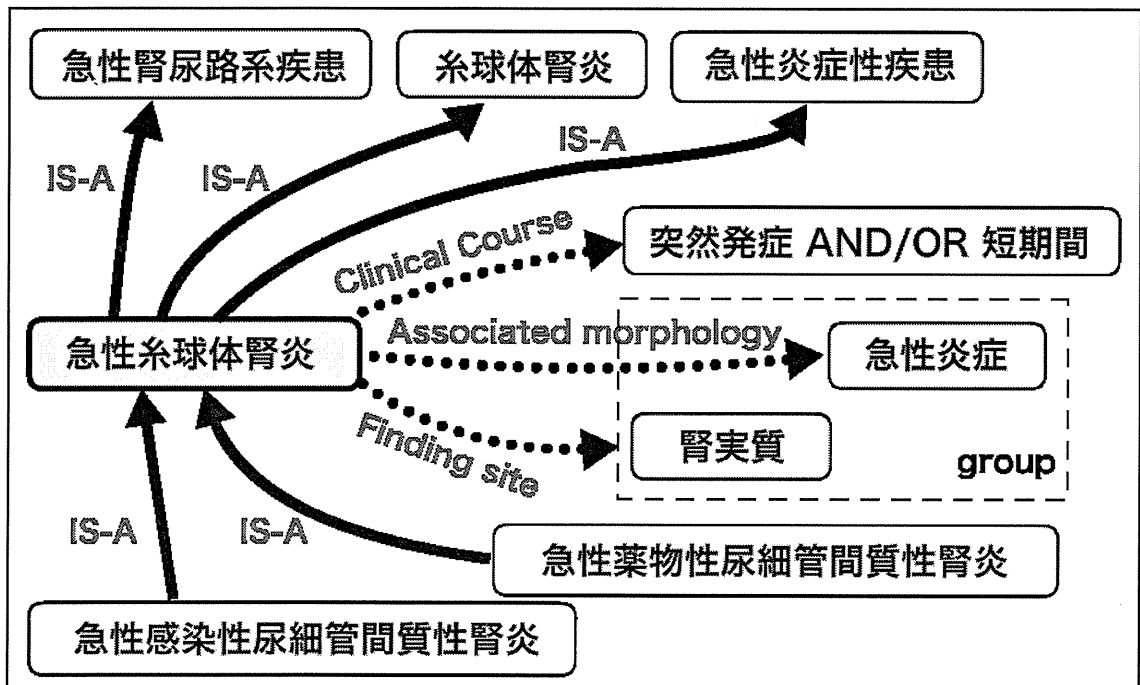

(図 4: SNOMED-CT における急性糸球体腎炎がもつ意味関係 (一部日本語に翻訳) 論文発表 (C) より抜粋)



図5 ICD11対応オミックスサブ情報モデル(iCOs α版)



図6 ICD11 Contents Model と iCOs

図7 ICD11 Omics SubModel beta (iCOSβ)

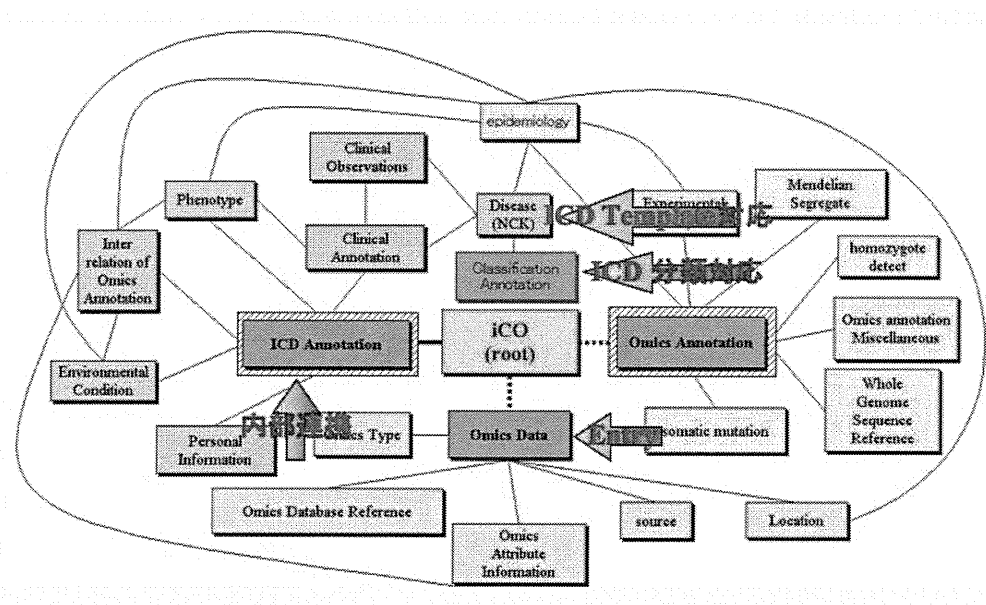

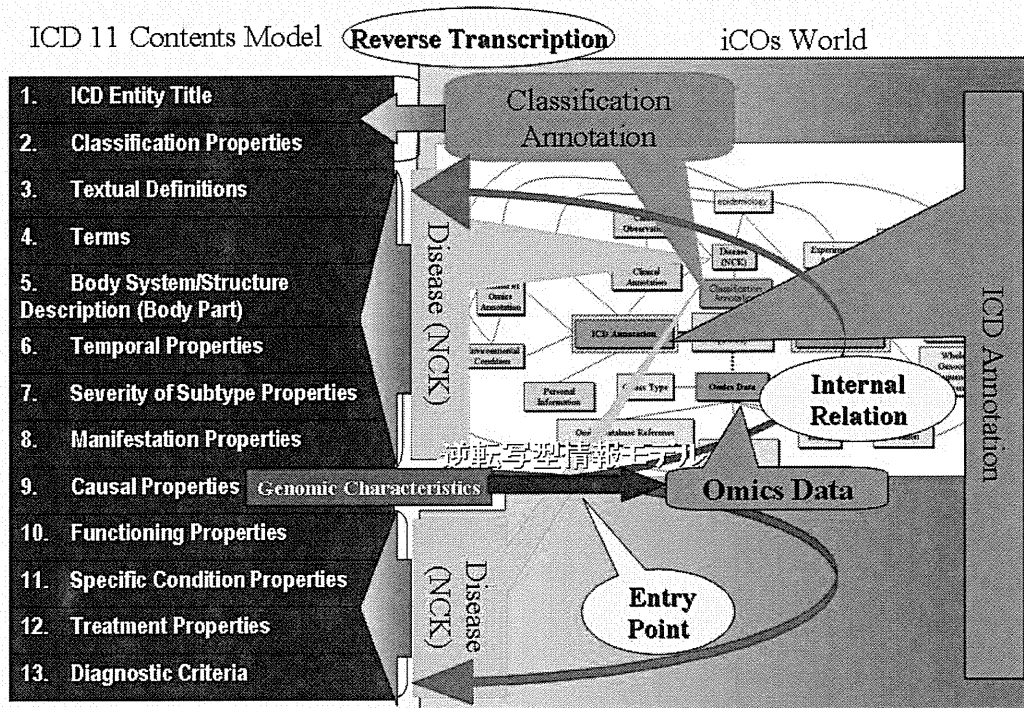
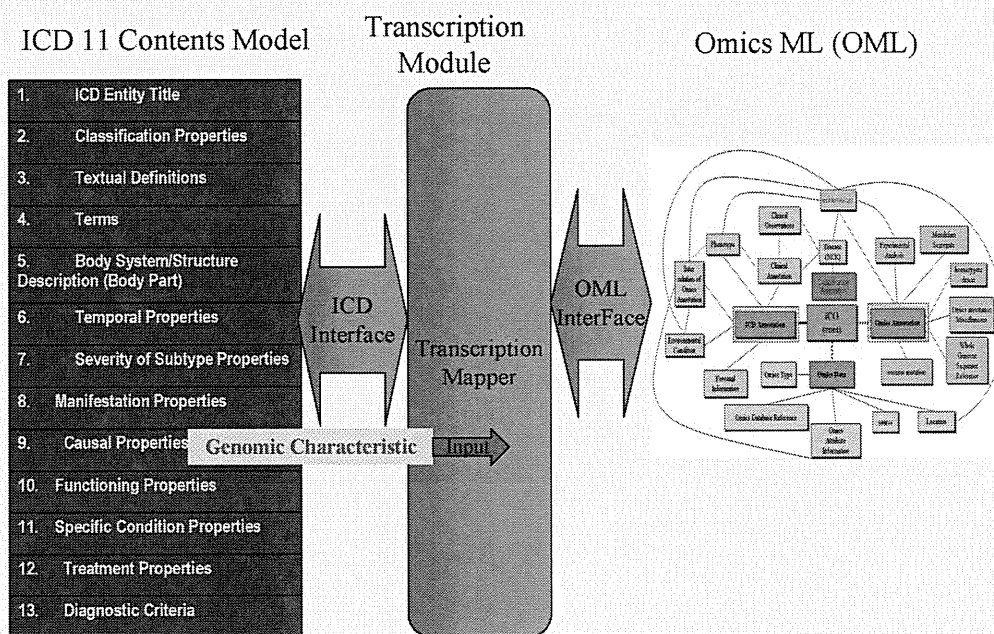
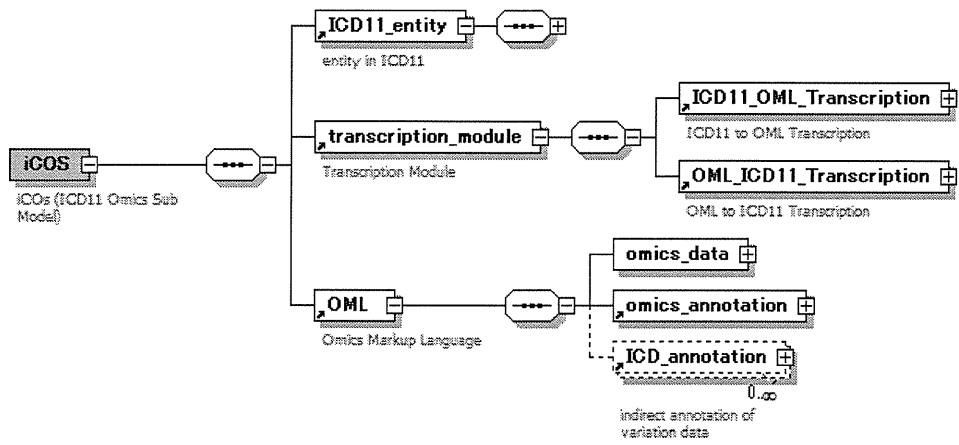

(图 8: iCOS 概略構成図)

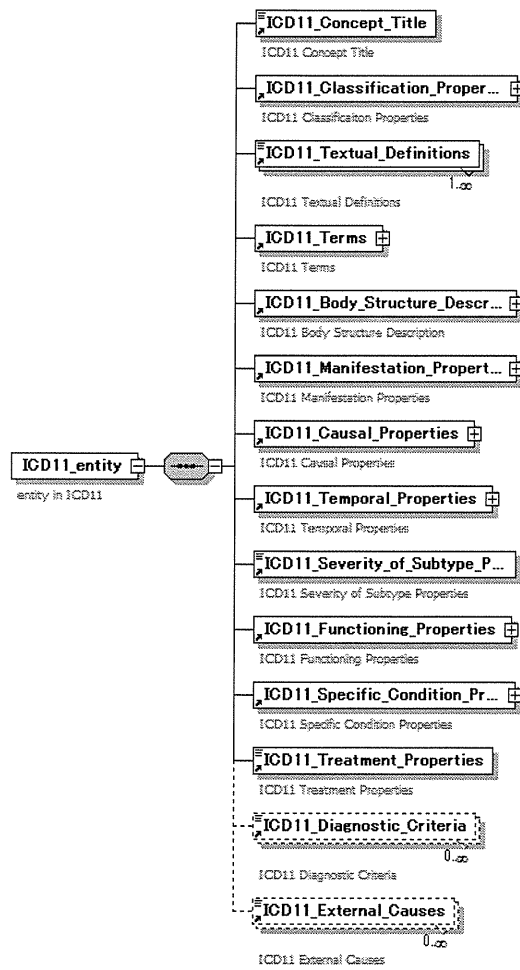

(图 9: ICD11 Entity)

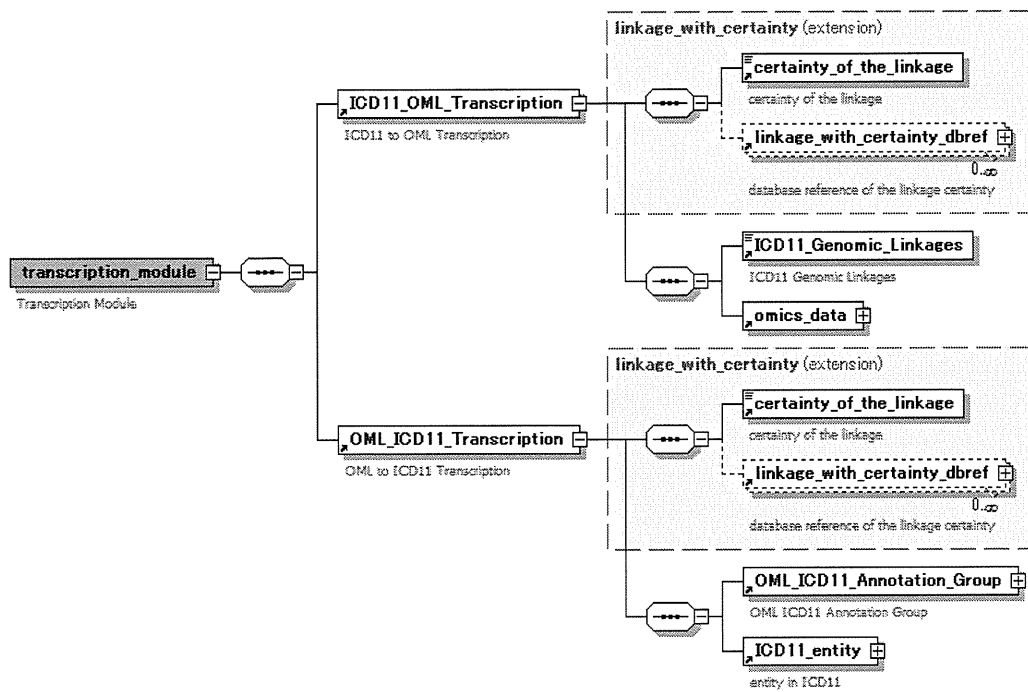

(图 10: Transcription Module)

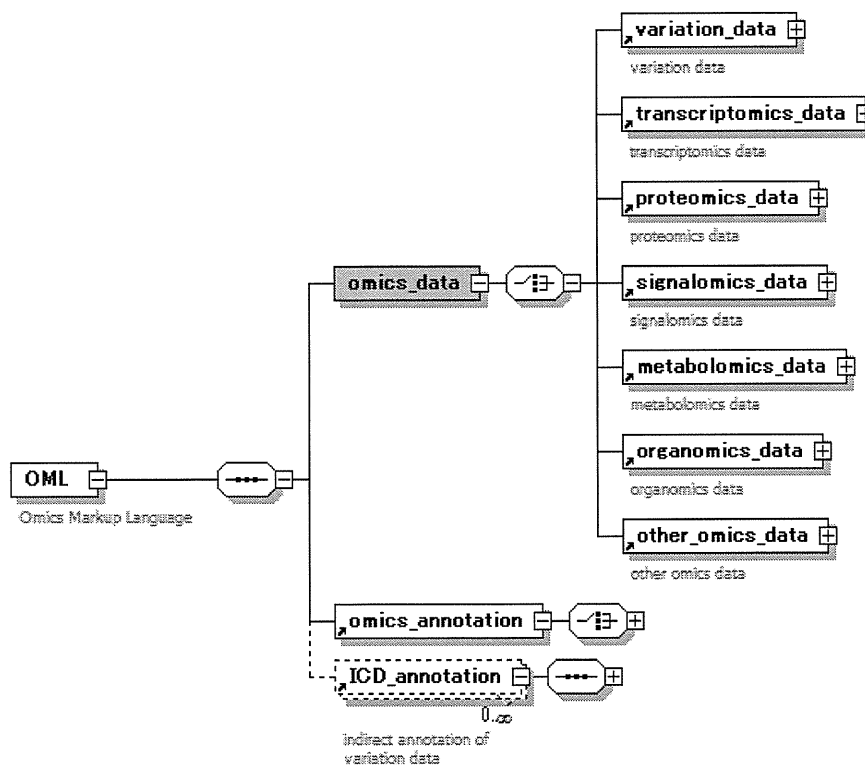

(图 11: OML Module)

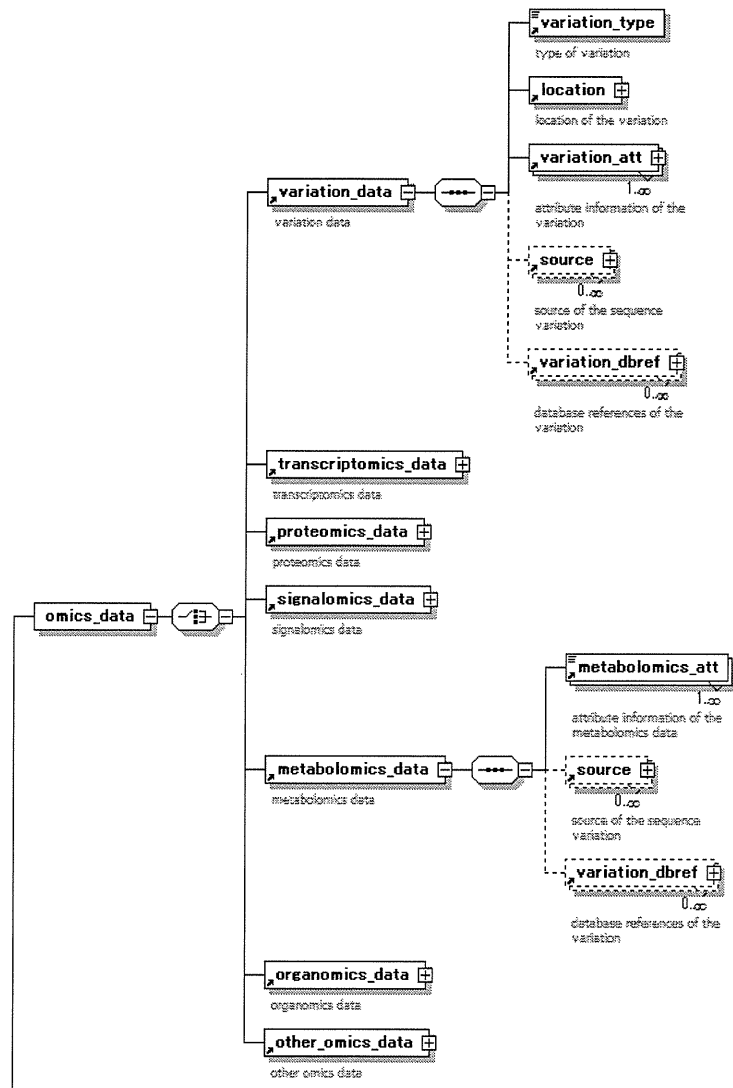

(図 12: オミックスデータの中の Variation Data とメタボロミクスデータ)

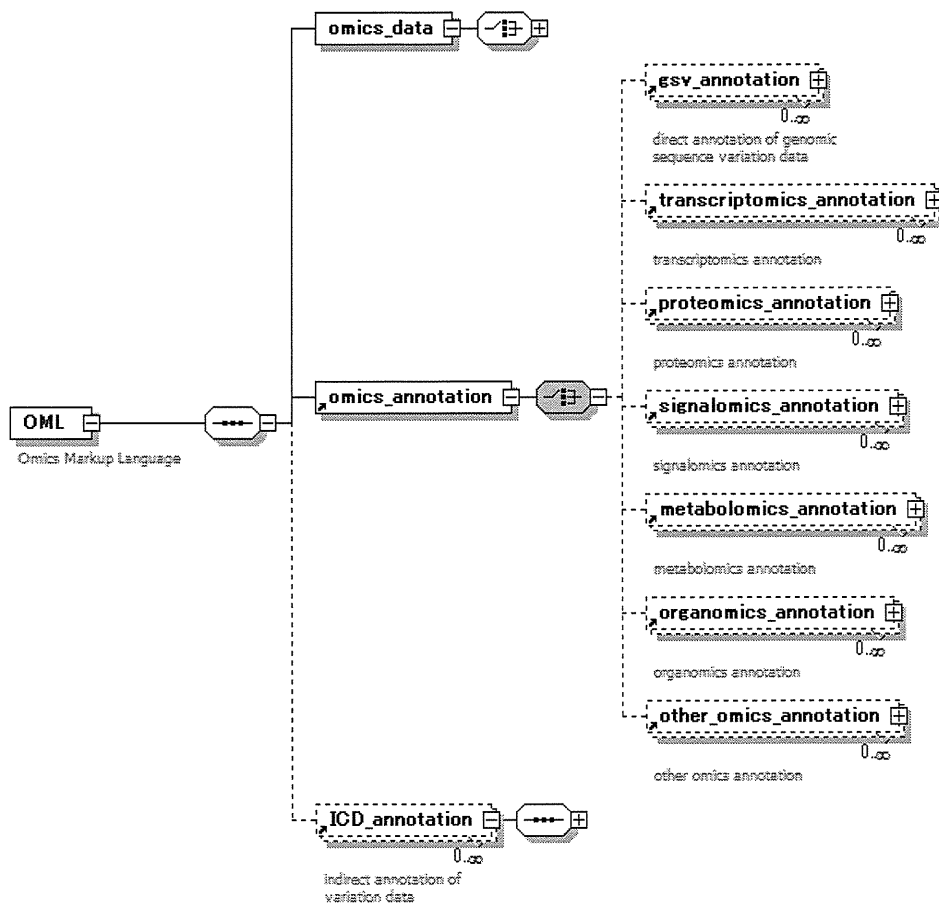

(図 13: OML の Omics Annotation 構造)

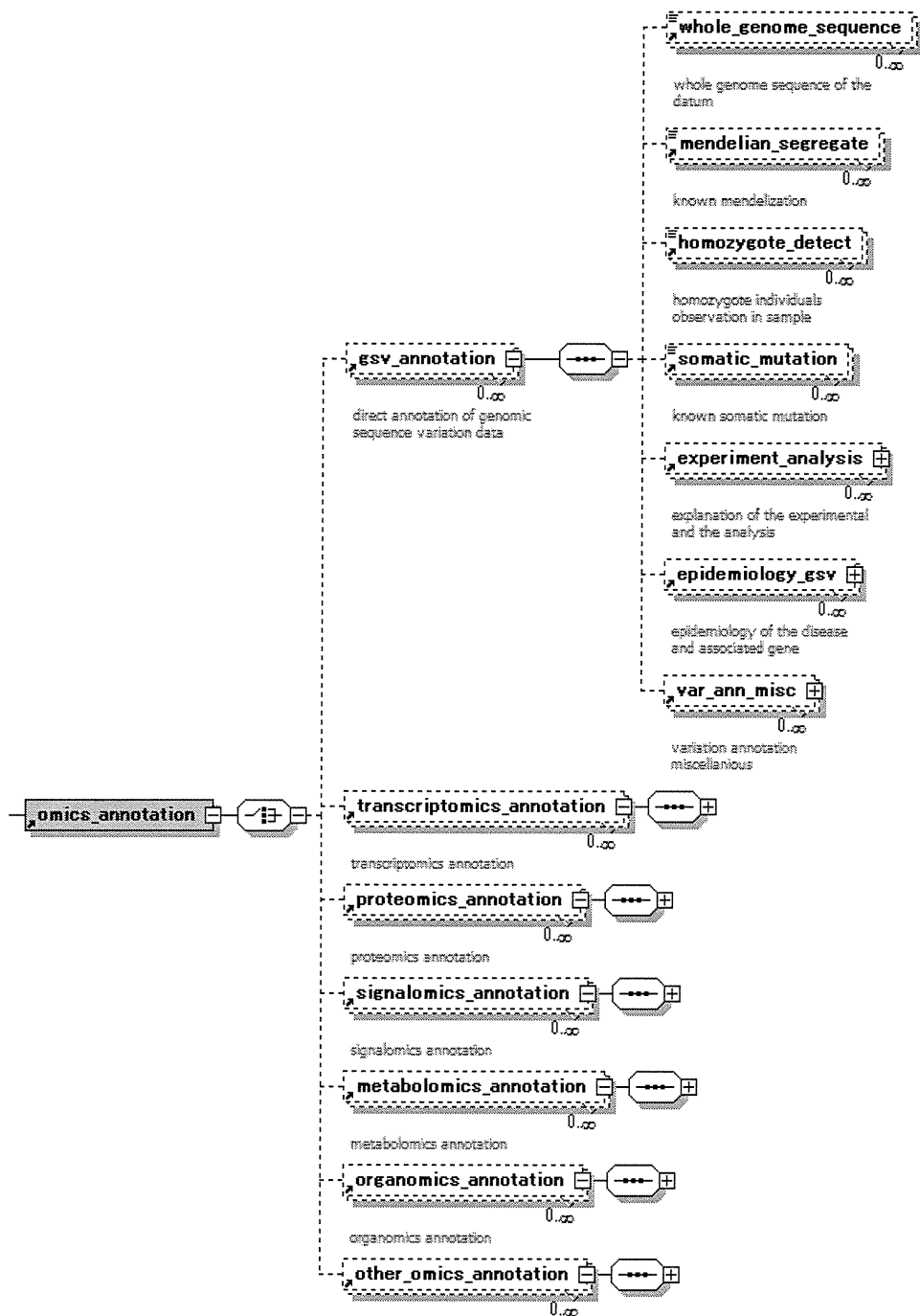

(図 14: Omics Annotation 情報 (Genomic Sequence Variation))

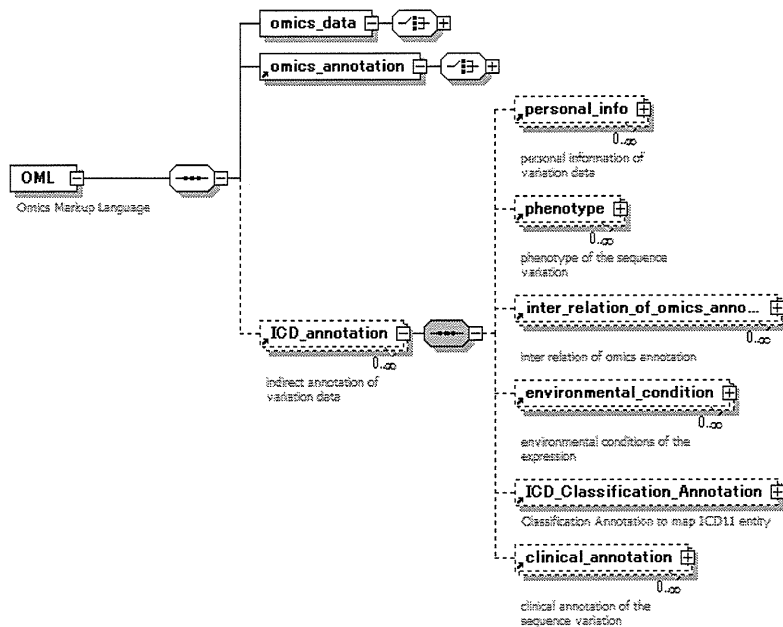

(図 15: ICD Annotation 構造)

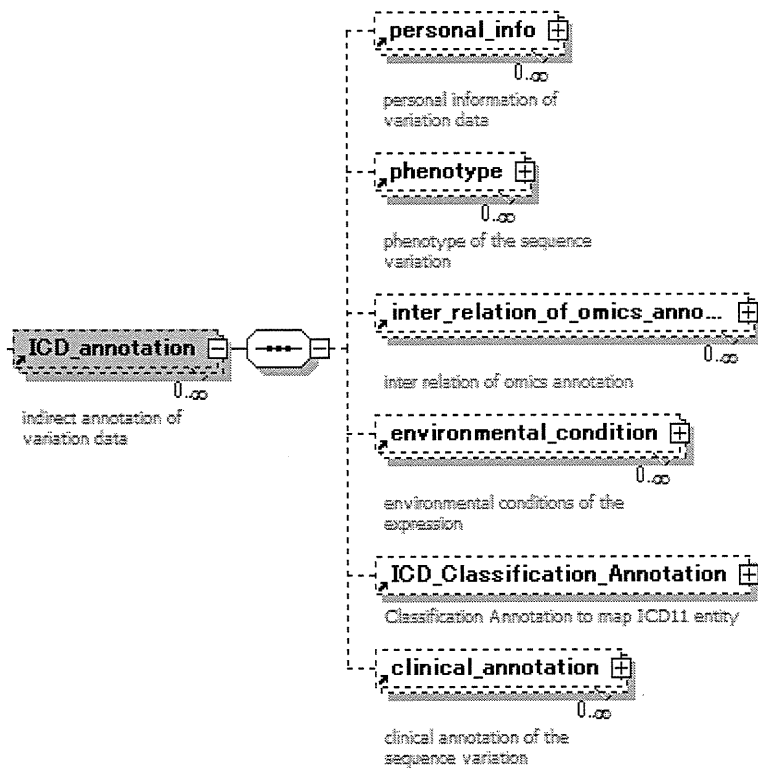

(図 16: ICD Annotation 構造 (Variation データの場合))

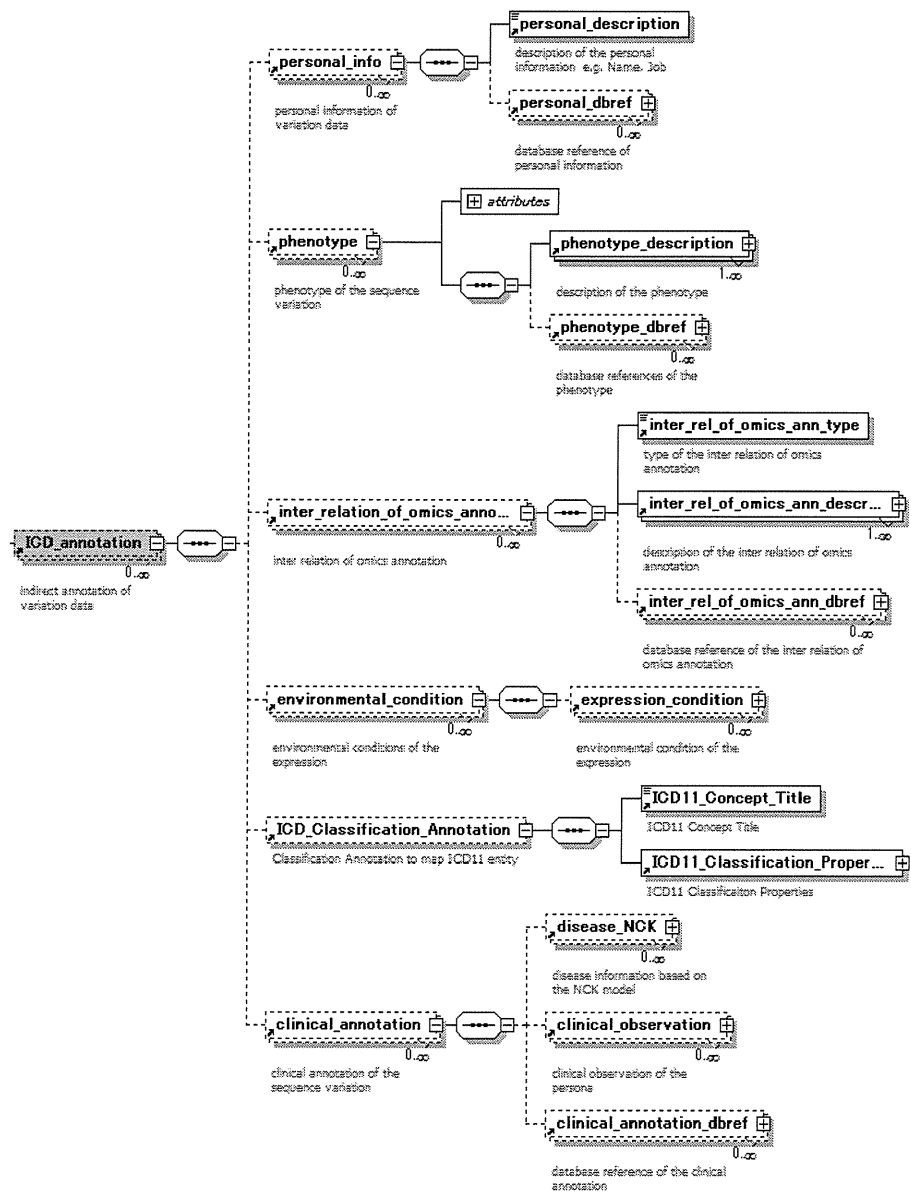

(図 17: ICD Annotation 詳細構造)

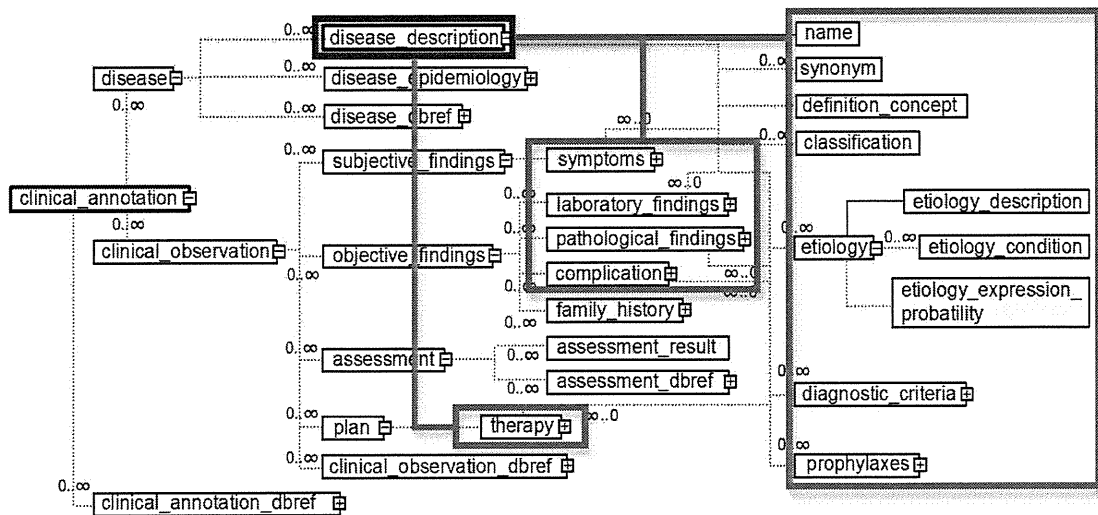

(図 18: Clinical Annotation 構造)

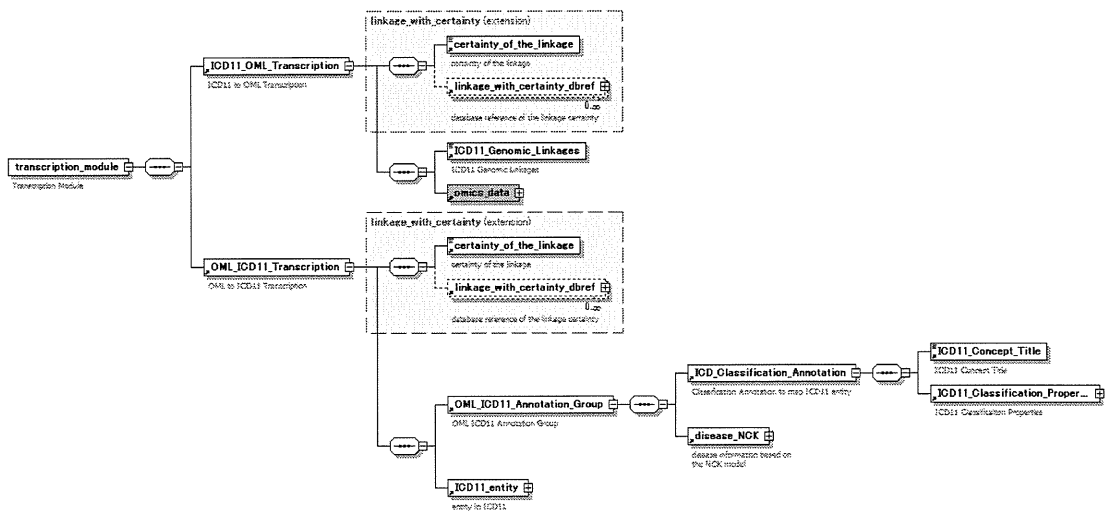

(図 19: Transcription Module 詳細構造)

III. 研究成果の刊行に関する一覧表

書籍

著者氏名	論文タイトル名	書籍名	出版社名	出版年	ページ
中谷 純	ゲノム・ポストゲノム	温泉の百科事典	丸善	in Press	in Press
中谷 純	地域医療連携ネットワークに関する標準化動向とセキュリティ対策	地域医療・福祉ネットワーク化白書 2012	シードプランニング	in Press	in Press
田中 博	地域医療福祉情報連携の現状と将来展望	地域医療・福祉ネットワーク化白書 2012	シードプランニング	in Press	in Press

雑誌

発表者氏名	論文タイトル名	発表誌名	巻号	ページ	出版年
Nakaya, J., Kimura, M., Hiroi, K., Ido, K., Yang, W., Tanaka, H	Genomic Sequence Variation Markup Language (GSVML)	International Journal of Medical Informatics (Int J Med Inform.)	79(2)	130-142	2010
Samson W. Tu, Olivier Bodenreider, Can Çelik, Christopher G. Chute, Sam Heard, Robert Jakob, Guoquian Jiang, Sukil Kim, Eric Miller, Mark M. Musen, Jun Nakaya, Jon Patrick, Alan Rector, Guillermo Reynoso, Jean Marie Rodrigues, Harold Solbrig, Kent A Spackman, Tania Tudorache, Stefanie Weber, Tevfik Bedirhan Üstün	A Content Model for the ICD-11 Revision	Journal of American Medical Informatics Association	In Submi ssion	In Submissi on	In Submissi on

発表者氏名	論文タイトル名	発表誌名	巻号	ページ	出版年
Michio Kimura, MD PhD, Jun Nakaya, MD PhD , Kazuhiko Ohe, MD PhD, Ryuichi Yamamoto, MD PhD, Mihoko Okada, PhD, Naoki Nakashima, MD PhD, Hideshige Hasegawa, Kazuyuki Nakayasu, Hiroshi Watanabe, MD, Shigeki Tani, PhD, Hiroshi Tanaka, PhD	A survey aimed at general citizens about their attitudes toward electronic medical data handling	Journal of American Medical Informatics Association	In submission	In submission	In submission
Jun Nakaya , Michio Kimura, Riichiro Mizoguchi, Kouji Kozaki, Kaei Hiroi , Keisuke Ido, and Hiroshi Tanaka	Semantics in the Japanese Integrated BioMedical Database	Journal of American Medical Informatics Association	In submission	In submission	In submission
Shigeki Tani PhD, Shinichi Higuchi, Goshi Fujimoto, Jun Nakaya MD, PhD , Michio Kimura MD, PhD	More powerful search engine invalidates anonymity guidelines for case reports	Methods of Information in Medicine (Methods Inf Med.)	In submission	In submission	In submission
Imai T , Kajino M, Sato M, Ohe K	Development of structured ICD-10 and its application to computer-assisted ICD coding	Studies in Health Technology and Informatics	160 (Pt 2)	1080-4	2010
Yamada E, Aramaki E, Imai T , Ohe K	Internal structure of a disease name and its application for ICD coding	Studies in Health Technology and Informatics	160 (Pt 2)	1010-4	2010
藤田伸輔, 今井 健	SNOMED-CT と ICD-11 に見る医学・医療分野の Ready to Use Ontology	人工知能学会誌	25(4)	501-508	2010

発表者氏名	論文タイトル名	発表誌名	巻号	ページ	出版年
Jun Nakaya, Michio Kimura, Riichiro Mizoguchi, Kouji Kozaki, Kaei Hiroi, Keisuke Ido, and Hiroshi Tanaka	Semantic Mechanisms in Clinical Omics Database.	InterOntology2012	-	pp 81-91	2012
今井健, 中谷純	ICD11 における オミックス情報 モデルの基礎検 討	医療情報学	31(Su pp1.)	81-86	2011

