

Table 1
Zeta potentials of various PEC prepared on a culture dish

	Culture	S-PEC	CM-PEC	P-PEC	SHA-PEC	HA-PEC
Zeta potential (mV)	-58.7	-28.0	34.5	24.9	-5.7	29.5

Table 2
The cell number and differentiation of NHOst cultured on various PEC films after 1 week

Samples	The cell number (percent against control)	ALP activity The cell number (ratio)	Ca amount The cell number ($\mu\text{g}/\text{ratio}$)
Collagen-coated dish	100.0 \pm 17.0	1.00 \pm 0.15	3.4 \pm 0.5
S-PEC	82.2 \pm 6.1	0.98 \pm 0.11	10.7 \pm 3.6
CM-PEC	6.0 \pm 2.6*	0.05 \pm 0.08*	27.4 \pm 3.0*
P-PEC	130.4 \pm 6.3	0.02 \pm 0.01*	2.5 \pm 0.8
SHA-PEC	71.4 \pm 22.1	1.35 \pm 0.48	2.1 \pm 1.0
HA-PEC	8.1 \pm 3.0*	0.52 \pm 0.31	38.3 \pm 12.3*
Chitosan	79.5 \pm 25.0	0.93 \pm 0.13	2.7 \pm 2.0

* $p < 0.01$ against collagen-coated dish.

with a carboxyl group, such as HA-PEC and CM-PEC, showed positive zeta potentials. In addition, P-PEC showed a positive potential less than that of HA-PEC. These data indicate that attachment of NHOst on surfaces with positive zeta potentials is reduced, suggesting the zeta potential of a PEC film partially controls cell attachment and morphology. Although all PEC were prepared by mixing anionic and cationic polysaccharides to neutralize their charge, zeta potential of each PEC film was ranged from -30 to 35 mV as shown in the table. This might indicate that not all anionic and cationic chemical groups were interacted to make PEC and their main chain composition and type of chemical groups may influence their side chain mobility, resulting in different surface zeta potential of each PEC. Details of surface properties of PEC films and their relationship to cell attachment will be reported in the near future.

After 1-week of incubation on various PEC films, the differentiation level of NHOst was estimated by measuring proliferation, alkaline phosphatase (ALP) activity and the amounts of calcium deposited. Table 2 shows the proliferation and ALP activity of NHOst cultured on various PEC films as well as the amounts of calcium deposited on the PEC. The proliferation of NHOst on the PEC is expressed as a percentage of proliferation of NHOst on a normal culture dish. The ALP activity was also calculated as a percentage of the control and normalized using the results of proliferation. In addition, the amount of calcium detected was normalized using the proliferation results as well. After a 1-week incubation, many dark spots, presumably calcium deposits, were observed on the collagen-coated dish and other PEC films (Fig. 2). When NHOst were

cultured on CM-PEC or HA-PEC, it was observed that the NHOst aggregates were covered by the calcium deposits. It was reported that a surface with carboxyl group could induce calcium deposition after its incubation in simulated body fluid [27]. However, when the PEC were incubated in the medium without NHOst, no calcium deposition was detected. In addition, zeta potential estimation suggests less carboxyl groups are appeared on a surface of the PEC. These indicate that calcium deposition occurred only on aggregated NHOst but not on surfaces lacking NHOst. Therefore, normalization is necessary to estimate the capacity of PEC films to induce NHOst differentiation, although the raw values of deposited calcium or ALP activity are low. In fact, CM-PEC or HA-PEC films show a capacity to induce NHOst differentiation comparable to the collagen-coated dish and other PEC films, judging from the normalized values of deposited calcium shown in the table, even though the ratio of NHOst number on them was only 6–8% of that on a collagen-coated dish. Their ALP activities were, however, much lower than those on the collagen-coated dish. Incubation of the PEC films without NHOst for 1 week resulted in no calcium deposition, irrespective of their composition, suggesting that the PEC films themselves had no effect on calcium deposition. Thus, enhancement of calcium deposition on the PEC films may be ascribed to enhancement of NHOst functions related to their differentiation even though their ALP activity was suppressed. The reason for this inconsistency observed between calcium deposition and ALP activity must be investigated further.

When sulfated polysaccharides were used to prepare PEC films, proliferation of NHOst on the PEC films was 70–80% of that on a collagen-coated dish, and ALP

activity was very similar to that on the collagen-coated dish. This suggests that sulfated polysaccharide PEC does not affect NHOst functions. Actually, there were no statistical differences in the amounts of calcium deposited between NHOst on the PEC and the collagen-coated dish although NHOst on S-PEC showed higher average calcium deposition. Thus, it is suggested that the PEC films made from sulfated polysaccharides are comparable substrates to a collagen-coated dish for cell culture. When compared to a normal culture dish, it has been reported that S-PEC can induce aggregation of cultured human fibroblasts and enhance their DNA synthesis in an earlier stage of cell culture by activation of the ERK pathway [28]. Since we used a collagen-coated dish as a control in this study, it is expected that the pathway of NHOst on the dish may be already activated through integrin molecules on the NHOst membrane. Therefore, the results in this study suggest the PEC from sulfated polysaccharides have a potential to proliferate and differentiate NHOst very similar to that of collagen.

To assess the effects of PEC films on cell function, gap junctional intercellular communication (GJIC), which is an important function of cells for maintenance of homeostasis [17], of NHOst on the films were measured. As shown in Fig. 4, GJIC of NHOst on PEC films did not show statistically significant differences compared to those grown on a collagen-coated dish. Although the GJIC of NHOst on CM-PEC showed a decrease after 1 day of incubation, it had recovered after 1 week. This result suggests that most PEC films have the potential to maintain homeostasis of attached cells although they showed different influences on the number and the

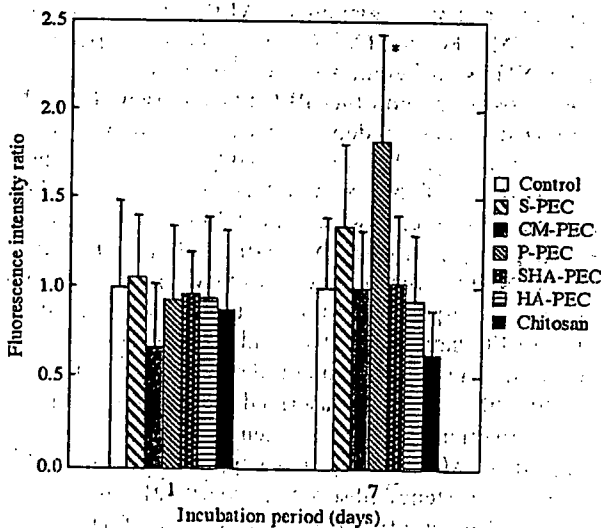

Fig. 4. Gap junctional intercellular communication activity of NHOst on various PEC films estimated by FRAP analysis technique. (* $p < 0.01$ against control).

differentiation of NHOst. On the other hand, NHOst on chitosan, which was used as the polycation for all PEC, showed suppression of GJIC after 1 week. This suggests that chitosan disturbs homeostasis maintenance of NHOst, but improve its biocompatibility by forming PEC films with other anionic polysaccharides. Therefore, PEC might be used as a biocompatible material for medical devices and tissue engineering scaffolds.

4. Conclusion

PEC films composed of various polysaccharides were prepared, and their effects on NHOst functions were evaluated. Attachment, morphology, growth and differentiation of NHOst were influenced by the composition of the PEC on which they were grown. NHOst attachment decreased and their aggregates were observed on PEC prepared from polysaccharides containing a carboxyl group (CM- and HA-PEC). ALP activity of NHOst was suppressed on these PEC films although calcium deposition was observed more frequently than on other PEC films. In addition, these PEC films strongly suppressed proliferation of NHOst. PEC prepared from phosphated chitin and chitosan (P-PEC) showed low ALP activity and calcium deposition, although the number of NHOst was highest after 1-week incubation. These indicate unsuitability of these three PEC for usage in tissue engineering. On the other hand, NHOst adhered to and proliferated well on PEC films when sulfated polysaccharides were used as the polyanion (S- and SHA-PEC). Moreover, these PEC films showed almost the same suitability as the collagen-coated dish in all cell functions studied, indicating that these PEC films, especially S-PEC can be used as a scaffold for bone regeneration. Further studies, especially in vivo studies, are needed to clarify the usefulness of PEC films for tissue engineering.

Acknowledgements

This work was partially supported by Health and Labour Sciences Research Grants for Research on Advanced Medical Technology and Risk Analysis Research on Food and Pharmaceuticals by Ministry of Health, Labour and Welfare, Health and Labour Sciences Research Grants for Research on Health Sciences focusing on Drug Innovation by the Japan Health Sciences Foundation, and Grant-in-Aid for 21st Century COE Program "Advanced Fiber Engineering" and Grant-in-Aid for Scientific Research (B), 2002 (14350495) by Ministry of Education, Science, Sports and Culture.

References

- [1] Adams JC, Watt FM. Regulation of development and differentiation by the extracellular matrix. *Development* 1993;117:1183–98.
- [2] Peterson WJ, Tachiki KH, Yamaguchi DT. Extracellular matrix alters the relationship between thymidine incorporation and proliferation of MC3T3-E1 cells during osteogenesis in vitro. *Cell Prolif* 2002;35:9–22.
- [3] Langer R, Vacanti JP. Tissue engineering. *Science* 1993;260:920–6.
- [4] Mooney DJ, Mikos AG. Growing new organs. *Sci Am* 1999;280:38–43.
- [5] Hori Y, Nakamura T, Matsumoto K, Kurokawa Y, Satomi S, Shimizu Y. Tissue engineering of the small intestine by acellular collagen sponge scaffold grafting. *Int J Artif Organs* 2001;24:50–4.
- [6] Yamamoto M, Takahashi Y, Tabata Y. Controlled release by biodegradable hydrogels enhances the ectopic bone formation of bone morphogenetic protein. *Biomaterials* 2003;24:4375–83.
- [7] Gamez E, Ikezaki K, Fukui M, Matsuda T. Photoconstructs of nerve guidance prosthesis using photoreactive gelatin as a scaffold. *Cell Transplant* 2003;12:481–90.
- [8] Lavik E, Teng YD, Snyder E, Langer R. Seeding neural stem cells on scaffolds of PGA, PLA, and their co-polymers. *Method Mol Biol* 2002;198:89–97.
- [9] Lieb E, Tessmar J, Hacker M, Fischbach C, Rose D, Blunk T, Mikos AG, Gopferich A, Schulz MB. Poly(D,L-lactic acid)-poly(ethylene glycol)-monomethyl ether diblock copolymers control adhesion and osteoblastic differentiation of marrow stromal cells. *Tissue Eng* 2003;9:71–84.
- [10] Shin M, Ishii O, Sueda T, Vacanti JP. Contractile cardiac grafts using a novel nanofibrous mesh. *Biomaterials* 2004;25:3717–25.
- [11] Alsberg E, Anderson KW, Albeiruti A, Rowley JA, Mooney DJ. Engineering growing tissues. *Proc Nat Acad Sci* 2002;99:12025–30.
- [12] Chang CH, Liu HC, Lin CC, Chou CH, Lin FH. Gelatin-chondroitin-hyaluronan tri-copolymer scaffold for cartilage tissue engineering. *Biomaterials* 2003;24:4853–8.
- [13] Tsuchida E, Abe K. Interactions between macromolecules in solution and intermacromolecular complexes. *Adv Polym Sci* 1982;45:1–119.
- [14] Hamano T, Teramoto A, Iizuka E, Abe K. Effects of polyelectrolyte complex (PEC) on human periodontal ligament fibroblasts (HPLF) function. I. Three-dimensional structure of HPLF cultured PEC. *J Biomed Mater Res* 1998;41:257–69.
- [15] Hamano T, Teramoto A, Iizuka E, Abe K. Effects of polyelectrolyte complex (PEC) on human periodontal ligament fibroblasts (HPLF) function. II. Enhancement of HPLF differentiation and aggregation on PEC by L-ascorbic acid and dexamethasone. *J Biomed Mater Res* 1998;41:270–7.
- [16] Hamano T, Chiba D, Nakatsuka K, Nagahata M, Teramoto A, Kondo Y, Hachimori A, Abe K. Evaluation of a polyelectrolyte complex (PEC) composed of chitin derivatives and chitosan, which promotes the rat calvarial osteoblast differentiation. *Polym Adv Technol* 2002;13:46–53.
- [17] Maio AD, Vaga VL, Contreras JE. Gap junctions, homeostasis, and injury. *J Cell Physiol* 2002;191:269–82.
- [18] Tsuchiya T, Hata H, Nakamura A. Studies on the tumor-promoting activity of biomaterials: inhibition of metabolic cooperation by polyetherurethane and silicone. *J Biomed Mater Res* 1995;29:113–9.
- [19] Tsuchiya T, Takahara A, Cooper SL, Nakamura A. Studies on the tumor-promoting activity of polyurethanes: depletion of inhibitory action of metabolic cooperation on the surface of a polyalkyleneurethane but not a polyetherurethane. *J Biomed Mater Res* 1995;29:335–41.
- [20] Nakaoka R, Tsuchiya T, Sakaguchi K, Nakamura A. Studies on in vitro evaluation for the biocompatibility of various biomaterials: inhibitory activity of various kinds of polymer microspheres on metabolic cooperation. *J Biomed Mater Res* 2001;279–84.
- [21] Nakaoka R, Tsuchiya T, Nakamura A. The inhibitory mechanism of gap junctional intercellular communication induced by polyethylene and the restorative effects by surface modification with various proteins. *J Biomed Mater Res* 2001;57:567–74.
- [22] Nagahata M, Tsuchiya T, Ishiguro T, Matsuda N, Nakatsuchi Y, Teramoto A, Hachimori A, Abe K. A novel function of N-cadherin and connexin 43: marked enhancement of alkaline phosphatase activity in rat calvarial osteoblast exposed to sulfated hyaluronan. *Biochem Biophys Res Commun* 2004;315:603–11.
- [23] Tamada Y, Ikada Y. Fibroblast growth on polymer surfaces and biosynthesis of collagen. *J Biomed Mater Res* 1994;28:783–9.
- [24] Ohyama M, Suzuki N, Yamaguchi Y, Maeno M, Otsuka K, Ito K. Effect of enamel matrix derivative on the differentiation of C2C12 cells. *J Periodontol* 2002;73:543–50.
- [25] Wade MH, Trosko JE, Schlindler M. A fluorescence photobleaching assay of gap junctional-mediated communication between human cells. *Science* 1986;232:525–8.
- [26] Kato S, Akagi T, Sugimura K, Kishida A, Akashi M. Evaluation of biological responses to polymeric biomaterials by RT-PCR analysis IV: study of c-myc, c-fos and p53 mRNA expression. *Biomaterials* 2000;21:521–7.
- [27] Tanahashi M, Matsuda T. Surface functional group dependence on apatite formation on self-assembled monolayers in a simulated body fluid. *J Biomed Mater Res* 1997;34:305–15.
- [28] Matsuda N, Horikawa M, Yoshida M, Watanabe M, Nagahata M, Teramoto A, Abe K. Enhanced DNA synthesis accompanied by constitutive phosphorylation of the ERK pathway in human fibroblasts cultured on a polyelectrolyte complex. *Biomaterials* 2003;24:4771–6.

Hydroxy apatite microspheres enhance gap junctional intercellular communication of human osteoblasts composed of connexin 43 and 45

Ryusuke Nakaoka, Saifuddin Ahmed, Toshie Tsuchiya

Division of Medical Devices, National Institute of Health Sciences, 1-18-1 Kamiyoga, Setagaya-ku, Tokyo 158-8501, Japan

Received 26 September 2004; revised 14 December 2004; accepted 14 December 2004

Published online 17 June 2005 in Wiley InterScience (www.interscience.wiley.com). DOI: 10.1002/jbm.a.30328

Abstract: The aseptic loosening of artificial joints with associated periprosthetic bone resorption may be partly due to the suppression of osteoblast function to form new bone by wear debris from the joint. To assess the effect of wear debris on osteoblasts, effects of model wear debris on gap junctional intercellular communication (GJIC) of normal human osteoblasts were estimated. The GJIC activity of the osteoblasts after a 1-day incubation with the microspheres was similar to that of normal osteoblasts. However, hydroxy apatite particles, which have been reported to enhance the differentiation of osteoblasts in contact with them, enhanced the GJIC function of the osteoblasts. From RT-PCR studies, not only connexin 43 but also connexin 45 is suggested to play a role in the GJIC of the osteoblasts in an early stage of

coculture with the microspheres, although it is still unclear how these connexins work and are regulated in the GJIC and differentiation. However, this study suggests that there is a relationship between the early levels of GJIC and the differentiation of the cells. Therefore, estimating the effect of biomaterials, even in the microsphere form, on the GJIC of model cells, with which the biomaterials may be in contact *in vivo*, can provide important information about their biocompatibility. © 2005 Wiley Periodicals, Inc. *J Biomed Mater Res* 74A: 181–186, 2005

Key words: gap junctional intercellular communication; human osteoblasts; microspheres; hydroxy apatite; connexin

INTRODUCTION

Biomaterials implanted into the harsh environment of the body cannot maintain their original shape, or even their desired function, sometimes resulting in undesirable side effects. One well-known example is the aseptic loosening of artificial joints observed in many patients who underwent a total joint replacement 5 to 25 years ago. It has already been reported that aseptic loosening with associated periprosthetic bone resorption is partly due to the activation of macrophages and osteoclasts by wear debris from the artificial joint.^{1–14} Macrophages stimulated by wear debris *in vitro* release significant amounts of inflammatory mediators such as interleukin-1, interleukin-6, prostaglandin E2, collagenase, and tumor necrosis factor.^{6–14} In addition, the biological effects of wear debris may depend on the type of material used as well

as the shape, size, and amount of the debris.^{4–11} Therefore, it is important to estimate the biocompatibility of biomaterials with not only their original shape but also possible transformed shapes after their usage.

During the last decade, we have been researching the inhibitory potential of many kinds of biomaterials on gap junctional intercellular communication (GJIC) as an index for their biocompatibility.^{15–18} GJIC is a function that plays an important role in maintaining cell and tissue homeostasis by exchanging low molecular weight molecules, which results in regulating cell growth, development, and differentiation of cells.^{19,20} Therefore, it is reasonable that disruption of this function is the cause of many kinds of diseases. In a previous report,¹⁸ we examined the inhibitory activity of polymer microspheres, which were used as model wear debris from biomedical polymer *in vivo*, on the GJIC of rodent-derived fibroblasts. We concluded that estimating the inhibitory activity of the microspheres on the GJIC might be useful for considering their side effects in the body. In other words, it may be possible to predict whether wear debris causes aseptic loosening of artificial joints by estimating their effect on GJIC function.

No benefit of any kind will be received either directly or indirectly by the authors

Correspondence to: R. Nakaoka; e-mail: nakoaka@nihs.go.jp

However, it must be noted that the effects of the microspheres may be different when the effects on the GJIC of human-derived cells are estimated. Osteoblasts have been reported to communicate with one another via GJIC function, and the function is believed to be critical to the coordinated cell behavior necessary in bone tissue development.^{21,22} Therefore, the question is raised whether wear debris has an inhibitory effect on the GJIC and the GJIC inhibition has a relation with the aseptic loosening of artificial joints. Because we have already observed some precoated polymer microspheres around 5 μm in diameter showed the potential to inhibit GJIC of fibroblasts contacting with them,²³ we estimated effects of various microspheres around 5 μm in diameter on GJIC function using normal human osteoblasts to discuss the relationship between the GJIC and the differentiation of osteoblasts. In this study, we employed fluorescence recovery after photobleaching (FRAP) analysis for estimating the GJIC function,¹⁷ and assessed the potential effect of many kinds of microspheres on the GJIC.

MATERIALS AND METHODS

Microspheres

Monodispersed polystyrene (PS) microspheres (5 μm in diameter) were purchased from Japan Synthetic Rubber Co., Ltd. (Tokyo, Japan). Low-density polyethylene (PE) microspheres were generously supplied by Sumitomo Seika chemicals Co., Ltd. (Tokyo, Japan). Alumina (Al_2O_3) microspheres were obtained from the Association of Powder Process Industry and Engineering. Sintered hydroxy apatite microspheres (HA, 7.2 μm in diameter) were prepared and supplied by Ube Material Industries, Ltd. A Multisizer II (Coulter Electronics Inc., Hialeah, FL) was used to determine the average diameter of PE and alumina microspheres: 6.4 and 5.1 μm , respectively. Microspheres were sterilized by dispersing them in a 70% ethanol solution, followed by centrifugation in sterile conditions to remove the ethanol solution. The microspheres were dispersed in sterile methanol for cell differentiation tests at specified concentrations. The suspension of microspheres in methanol was added to 35-mm type I collagen-coated cell culture dishes (Asahi techno glass, Chiba, Japan), and the plates dried overnight at room temperature. The obtained microsphere-coated dishes (100 μg /dish) were subjected to the assays.

Cell culture

Normal human osteoblasts (NHOst) were purchased from BioWhittaker Inc. (Walkersville, MD). The standard culture of NHOst was performed using alpha minimum essential medium (Gibco) containing 20% fetal calf serum (FCS) (Kokusai Shiyaku Co., Ltd., Tokyo, Japan). The cells were

maintained in incubators under standard conditions (37°C, 5% CO_2 -95%-air, saturated humidity). All assays were performed using alpha minimum essential medium containing 20% FCS, supplemented with 10 mM beta-glycerophosphate. NHOst (1×10^5 cells/dish/2.5 mL medium) were cultured on microsphere-coated dishes for estimating the effect of the microspheres interacted from the bottom of the cells. To estimate the effect of microspheres on cells adhered to the culture plates, the NHOst cells were cultured with microsphere-containing medium (100 μg /2.5 mL medium) after they had adhered to the collagen-coated dishes. The test cells were cultured while changing the medium three times when the measurement of GJIC was performed after a 7-day incubation.

Measurement of GJIC activities

NHOst cultured with microspheres were subjected to fluorescence recovery after photobleaching (FRAP) analysis to estimate the inhibitory activity of these microspheres toward the GJIC. FRAP analysis was carried out according to an original procedure by Wade et al.,²⁴ with some modifications.¹⁷ Briefly, NHOst were plated on microsphere-coated dishes and incubated for 1 or 7 days. After a wash with phosphate buffer saline (PBS) containing MgCl_2 and CaCl_2 [PBS(+)], the cells were incubated for 5 min at room temperature in PBS(+) containing 5,6-carboxyfluorescein diacetate (7 $\mu\text{g}/\text{mL}$, excitation 488 nm and emission 515 nm). After the washing off of excess extracellular dye with PBS(+), the cells in the test dishes in PBS(+) were subjected to the FRAP analysis. In the control experiment, cells were inoculated on an untreated glass bottom dish and treated with the same procedure as the tested cells. Cells in contact with test microspheres and at least two other cells were subjected to FRAP analysis under an Ultima-Z confocal microscope (Meridian Instrument, Okemos, MI) with a 10 \times objective lens at room temperature. The cells were photobleached with a 488-nm beam and the recovery of fluorescence intensity was subsequently monitored at 1-min intervals for a total period of 4 min. The data obtained from more than seven independent cells were expressed as the average of fluorescence recovery rate in comparison to the rate obtained from NHOst cultured without microspheres.

Effect of microspheres on calcium deposition by NHOst

The amount of calcium deposited during a 7-day incubation of the cells were evaluated as follows: NHOst were cocultured with either precoated or added microspheres in 24-well collagen-coated culture plates (Asahi techno glass, Chiba, Japan) for 1 week (2×10^4 cells/20 μg microspheres/well/500 μL medium). After the cells were fixed in formaldehyde, 0.5 mL of 0.1 M HCl was added to each well after washing the cells with PBS. The amounts of calcium dissolved in HCl were estimated using a Calcium detecting kit (Calcium-C test Wako, Wako, Osaka, Japan) according to the manufacturer's direction.

RT-PCR for estimating expression of connexins

According to the method reported by Ichikawa et al.,²⁵ RT-PCR was performed to detect the expression of connexin mRNA in NHOst. After culturing NHOst with microspheres for a scheduled time, total RNA was extracted from the NHOst using TRIZOL[®] reagent (Invitrogen Corp., Carlsbad, CA) according to the manufacturer's instructions. After dissolving the RNA in diethylpyrocarbonate-treated water, the total RNA concentration was measured spectrophotometrically using Genequant (Amarsham Biosciences Corp., Piscataway, NJ). RNA samples were adjusted to a minimum concentration among collected samples in each experiment and reversibly transcribed to cDNA using Superscript[™] II (Invitrogen Corp.). For PCR amplification of human connexin 45, Takara Ex-Taq[™] (Takara Shuzo Co., Ltd., Shiga, Japan) was used with Ex-Taq[™] buffer consisting of 20 pmol each of two human connexin-45 specific primers (forward 5'GTGGCAACTCCCTCTGTGAT3' and reverse 5'GGATCCTCAAGTCCCTCCT3'). For PCR amplification of human connexin 26, 32, and 43, Takara LA-Taq[™] (Takara Shuzo Co., Ltd.) was used with Ex-Taq[™] buffer consisting of 6 pmol each of the human connexin-specific primers (for connexin 26, forward 5'ATGGATTGGGGCACGC3' and reverse 5'TTAAACTGGCTTTTTTGACTTCCC3'. For connexin 32, forward 5'ATGAAGTGGACAGGTTTGTACACCTTGCTC3' and reverse 5'TCAGCAGGCCGAGCAGCGG3'. For connexin 43, forward 5'ATGGGTGACTGGAGCGCCTTAGGC3' and reverse 5'CTAGATCTCCAGGTCATCAGGCCG3'). The PCR profile for connexin 45 involved pretreatment at 95°C for 2 min, followed by 35 cycles of denaturation at 95°C for 45 s, annealing at 54°C for 45 s, and extension at 72°C for 90 s. The PCR profile for connexin 26, 32, and 43 (35 times) was as follows: pretreatment at 95°C for 2 min, denaturation at 95°C for 30 s, annealing at 54°C for 30 s, and extension at 72°C for 120 s. Reaction products were analyzed by electrophoresis in 1.5% (w/v) agarose gel, followed by staining of

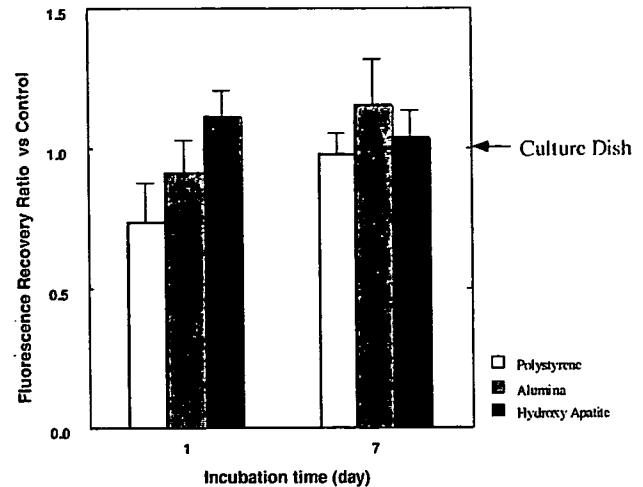

Figure 2. Effect of added microspheres on gap junctional intercellular communication of NHOst estimated from fluorescence recovery rates of target cells. The recovery rates of the cells on untreated culture dishes on days 1 and 7 were used as standards of all obtained data, respectively.

the products by SYBR[®] Green I (Takara Shuzo Co., Ltd.) and detection of a 566-bp (connexin 45), 671-bp (connexin 26), 852-bp (connexin 32), and 1149-bp (connexin 43) band, respectively. For the standardization of connexin cDNA, PCR amplification of glyceraldehyde-3-phosphate dehydrogenase (GAPDH) mRNA in each sample was performed using GAPDH-specific primers (forward 5'CCCATCACCATCTTCCAGGAGCGAGA3' and reverse 5'TAAGTAGGACAA-CAAGGAGGTCTGACGACGC3'; product size 578-bp). All reactions included negative controls without cDNA.

Statistical analysis

All data were expressed as the mean value ± the standard error of the means of the obtained data and treated statistically with Student's *t* test.

RESULTS

Figure 1 shows effects of various microspheres on GJIC of NHOst in contact with the microspheres for 1 and 7 days. The microspheres were precoated on 35-mm culture dishes before cell seeding. When the NHOst were cultured with precoated PS, PE, and alumina microspheres, their GJIC level was similar to that in NHOst cultured on a normal culture dish. On the other hand, the GJIC level was 1.5 times that of NHOst on the normal dish when they were cultured with precoated hydroxy apatite microspheres. After 7 days, the GJIC of NHOst in contact with microspheres became similar to that of normal NHOst, irrespective of the type of microsphere. The change in GJIC of NHOst in contact with added microspheres is shown in Figure 2. As seen in Figure 1, hy-

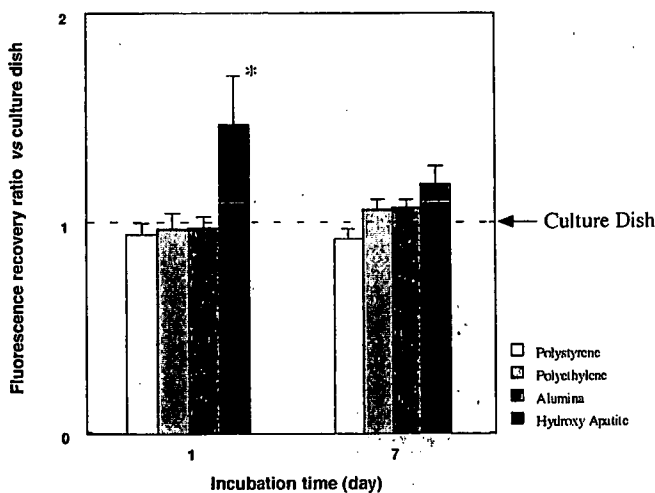

Figure 1. Effect of precoated microspheres on gap junctional intercellular communication of NHOst estimated from fluorescence recovery rates of target cells. The recovery rates of the cells on untreated culture dishes on days 1 and 7 were used as standards of all obtained data, respectively. (**p* < 0.01 against culture dish).

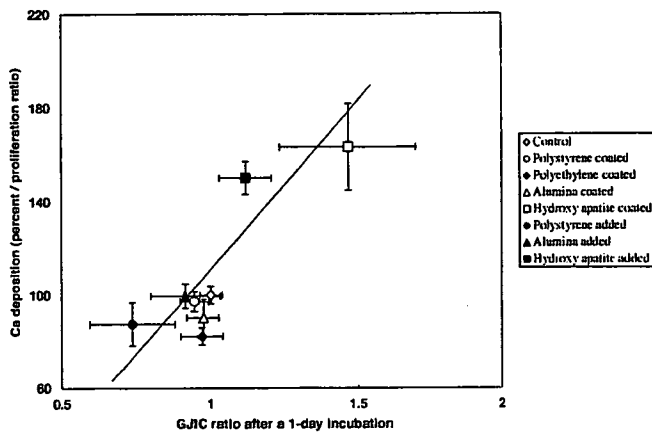

Figure 3. Relationship between GJIC on day 1 and calcium deposition ratio after 7-day coculture of NHOst with various microspheres ($r^2 = 0.74$).

droxy apatite microspheres enhanced their GJIC after a 1-day culture compared to cells on a normal plate. The degree of enhancement of GJIC is, however, smaller than that seen in NHOst in Figure 1, and no significant difference was observed between NHOst in contact with the hydroxy apatite microspheres and those cultured without microspheres. In addition, Figure 2 indicates that addition of PS microspheres into a culture of NHOst inhibited GJIC.

To consider the effects of tested microspheres on not only GJIC but also the differentiation of NHOst, changes in the amount of calcium deposited after a 1-week coculture of NHOst with various microspheres were estimated. From Figure 3, it is suggested that there is the possible relation between the GJIC of NHOst cocultured with microspheres for 1 day and

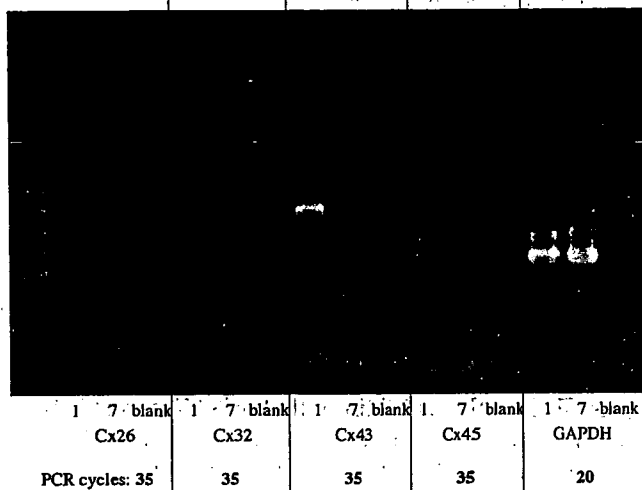

Figure 4. Expression of mRNA of various connexins (Cx) in NHOst cultured for 1 and 7 days. The number of NHOst cultured on 35-mm collagen-coated culture dishes was 2×10^5 . RT-PCR cycles of each lane are expressed at the bottom of the figure.

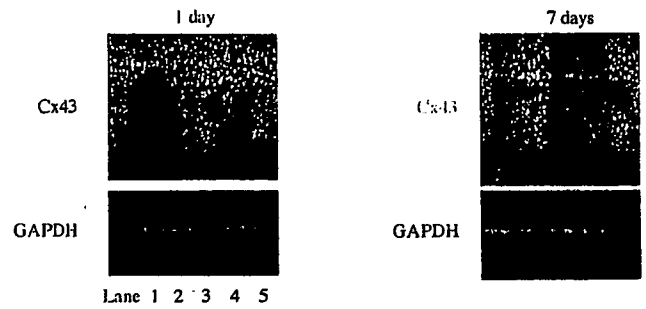

Figure 5. Expression of connexin 43 (Cx 43) mRNA in NHOst cultured with various precoated microspheres. The number of PCR cycles for connexin 43 and GAPDH is 35 and 20, respectively. Lane 1: without microspheres; lane 2: with PS microspheres; lane 3: with PE microspheres; lane 4: with alumina microspheres; lane 5: with HA microspheres.

the amount of calcium deposited after a 1-week coculture with the same microspheres.

To clarify which connexins exist in NHOst, we performed RT-PCR to detect mRNA of connexin 26, 32, 43, and 45 in NHOst cultured on a normal culture dish. Figure 4 shows the result of RT-PCR to amplify the mRNA from whole RNA collected from NHOst cultured for 1 and 7 days. As shown in the figure, only connexin 43 and 45 were detected in NHOst. When cells were cultured for 7 days, connexin 43 was detected at a lower level than that detected after the 1-day culture, while connexin 45 was not detected.

Figures 5 and 6 show the results of RT-PCR to amplify mRNA of connexin 43 and 45 in NHOst cultured with various precoated microspheres. The NHOst cultured with microspheres did not express mRNA of connexin 43, except those with PE microspheres. After 7 days, the expression was suppressed in the normal NHOst while the expression was observed in NHOst cultured with microspheres, irrespective of kind of the microsphere. On the other hand, mRNA expression of connexin 45 was suppressed after a 1-day culture of NHOst only with alumina microspheres, followed by a decrease in expression of the mRNA after their 7-day culture.

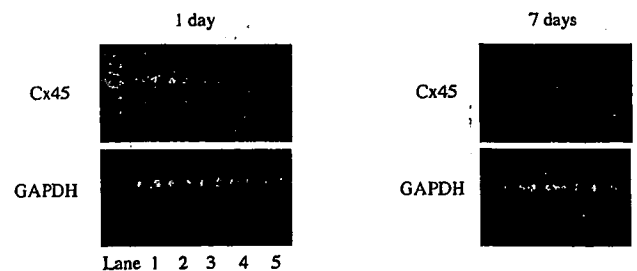

Figure 6. Expression of connexin 45 (Cx 45) mRNA in NHOst cultured with various precoated microspheres. The number of PCR cycles for connexin 45 and GAPDH is 40 and 20, respectively. Lane 1: without microspheres; lane 2: with PS microspheres; lane 3: with PE microspheres; lane 4: with alumina microspheres; lane 5: with HA microspheres.

DISCUSSION

As shown in Figure 3, normal human osteoblasts (NHOst) in contact with microspheres showed different levels of calcium deposition only after a 1-week culture, suggesting composition of the microspheres affects NHOst differentiation level. The differentiation was suppressed by the contact with PS, PE, and alumina microspheres, while HA microspheres showed the potential to enhance the differentiation. It has been reported that GJIC plays an important role in not only the homeostasis of cells but also their differentiation.¹⁹⁻²² In addition, GJIC is affected by the microsphere's composition, as has been reported using a fibroblast cell line.¹⁸ Therefore, the results shown in Figures 1 and 2 suggest that the enhanced differentiation of NHOst relates to GJIC enhancement on a 1-day culture in contact with HA microspheres, especially the precoated microspheres. In addition, on coculture with other microspheres, GJIC was slightly suppressed at 1 day, although no significant difference compared to control NHOst was observed. We have already studied effects of the microspheres on NHOst differentiation, and enhancement of calcium deposition by coculture with the hydroxy apatite microspheres was observed. Figure 3 suggests a relationship between the calcium deposition and GJIC on day 1. This also indicates that GJIC of the NHOst, in contact with materials in the microsphere form, in the early stage may be one factor affecting their differentiation.

It has been reported that GJIC of cells derived from human osteoblasts is mainly composed of connexin 43 and 45.^{22,26,27} In this study, it is also indicated that GJIC of NHOst is composed of connexin 43 and 45 (Fig. 4). Therefore, it is possible that changes in the level of their GJIC is ascribed to the change in mRNA expression level of connexin 43 and 45 and their expression ratio. From Figures 5 and 6, mRNA of connexin 43 was expressed only in normal NHOst and those cultured with PE microspheres, while it was slightly expressed in NHOst cocultured with HA. On the other hand, mRNA of connexin 45 was expressed in NHOst in all conditions, except those cocultured with alumina microspheres. Because HA was observed to enhance GJIC of NHOst, this suggests that connexin 45 may play a role in GJIC at an early stage. This also suggests that a higher level of connexin 45 than that of connexin 43 may be important in the enhancement of GJIC. However, although the mRNA expression of neither connexin 43 nor 45 was observed in NHOst cocultured with alumina microspheres, their GJIC was similar to that of normal NHOst. Moreover, it has reported that gap junctions formed by connexin 43 are more permeable to negatively charged dyes such as lucifer yellow, calcein, and carboxyfluorescein used in this study, more than those formed by

connexin 45, and an increase of connexin 43 expression and GJIC function parallel osteoblast differentiation.^{22,28} These are inconsistent with our findings and indicate that not high expression, but a rapid decrease of connexin 45 mRNA is probably very important for GJIC change and differentiation of the osteoblasts. Therefore, even though connexin 45 may play an important role in the early stage of GJIC in NHOst, it is probable that another connexins or other mechanisms of GJIC play a role in the GJIC of NHOst.

Because many proteins are involved in GJIC formation,²⁸ other mechanisms or proteins may be important in the GJIC change induced by the contact with the microspheres. It has reported that cadherins, which are important proteins for form tight junction between cells, control connexin 43-mediated GJIC.^{29,30} In addition, a microtubule network inside a cell has been reported to play an important role as guidance for delivery of connexons, which are composed of six connexin molecules, to the cell membrane to make gap junctions.³¹ Usually, surface characteristics of materials affect cell attachment as well as cell morphology, suggesting signal cascades of cell attachment and cytoskeleton rearrangement in the cell were influenced by the characteristics. Therefore, it is probable that a surface characteristic of the microspheres affect these molecules in NHOst, resulting in changes of GJIC activities. Further studies on changes in not only connexin molecules but also other molecules such as cadherin, actin, and microtubule in NHOst, is necessary to clarify the mechanism of GJIC. In the future, we will study the above, and find another molecules participating in the GJIC of NHOst and the mechanisms regulating the connexins in NHOst.

In conclusion, the GJIC level of NHOst changes on contact with microspheres, and is affected by the composition of the microspheres. The GJIC level in the early stage might be important in the differentiation control of NHOst and the level may be controlled partly by expression of connexin 43, connexin 45, and unclarified connexins in addition to other mechanisms regulating GJIC function. Detecting a biomaterial's effect on the GJIC of human cells may be one useful method for estimating its biocompatibility.

The authors appreciate the support of Health and Labor Sciences Research Grants for Research on Advanced Medical Technology, Research on Health Sciences focusing on Drug Innovation, and Risk Analysis Research on Food and Pharmaceuticals, Ministry of Health, Labour and Welfare.

References

1. Willert HG, Semlitsch M. Reactions of the articular capsule to wear products of artificial joint prosthesis. *J Biomed Mater Res* 1977;11:157-164.

2. Savio JA III, Overcamp LM, Black J. Size and shape of biomaterial wear debris. *Clin Mater* 1994;15:101-147.
3. Wang W, Ferguson DJP, Quinn JMW, Simpson AHRW, Athanasou NA. Osteoclasts are capable of particle phagocytosis and bone resorption. *J Pathol* 1997;182:92-98.
4. Goodman SB, Fornasier VL, Lee J, Kei J. The histological effects on the implantation of different sizes of polyethylene particles in the rabbit tibia. *J Biomed Mater Res* 1990;24:517-524.
5. Kubo T, Sawada K, Hirakawa K, Shimizu C, Takamatsu T, Hirasawa Y. Histiocyte reaction in rabbit femurs to UHMWPE, metal, and ceramic particles in different sizes. *J Biomed Mater Res* 1999;45:363-369.
6. Shanbhag AS, Jacobs JJ, Black J, Galante JO, Glant TT. Macrophages/particle interactions: Effect of size, composition and surface area. *J Biomed Mater Res* 1994;28:81-90.
7. Kim KJ, Itoh T, Tanahashi M, Kumegawa M. Activation of osteoclasts-mediated bone resorption by the supernatant from a rabbit synovial cell line in response to polyethylene particles. *J Biomed Mater Res* 1996;32:3-9.
8. Voronov I, Santerre JP, Hinek A, Callahan JW, Sandhu J, Boynton EL. Macrophage phagocytosis of polyethylene particles in vitro. *J Biomed Mater Res* 1998;39:40-51.
9. Catelas I, Huk OL, Petit A, Zukor DJ, Marchand R, Yahia L. Flow cytometric analysis of macrophage response to ceramic and polyethylene particles: Effects of size, concentration, and composition. *J Biomed Mater Res* 1998;41:600-607.
10. Green TR, Fisher J, Stone MH, Wroblewski BM, Ingham E. Polyethylene particles of a "critical size" are necessary for the induction of cytokines by macrophages in vitro. *Biomaterials* 1998;19:2297-2302.
11. Green TR, Fisher J, Matthews JB, Stone MH, Ingham E. Effect of size and dose on bone resorption activity of macrophages by in vitro clinically relevant ultra high molecular weight polyethylene particles. *J Biomed Mater Res (Appl Biomater)* 2000;53:490-497.
12. Takei I, Takagi M, Santavirta S, Ida H, Hamasaki M, Ishii M, Fukushima S, Ogino T, Konttinen YT. Matrix metalloproteinases and tissue inhibitors of metalloproteinases in joint fluid of the patients with loose artificial hip joints. *J Biomed Mater Res* 1999;45:175-183.
13. Trindade MCD, Schurman DJ, Maloney WJ, Goodman SB, Smith RL. G-protein activity requirement for polymethylmethacrylate and titanium particle-induced fibroblast interleukin-6 and monocyte chemoattractant protein-1 release in vitro. *J Biomed Mater Res* 2000;51:360-368.
14. Sacomen D, Smith RL, Song Y, Fornasier V, Goodman SB. Effects of polyethylene particles on tissue surrounding knee arthroplasties in rabbits. *J Biomed Mater Res (Appl Biomater)* 1998;43:123-130.
15. Tsuchiya T, Hata H, Nakamura A. Studies on the tumor-promoting activity of biomaterials: Inhibition of metabolic cooperation by polyetherurethane and silicone. *J Biomed Mater Res* 1995;29:113-119.
16. Nakaoka R, Tsuchiya T, Kato K, Ikada Y, Nakamura A. Studies on tumor-promoting activity of polyethylene: Inhibitory activity of metabolic cooperation on polyethylene surfaces is markedly decreased by surface modification with collagen but not with RGDS peptide. *J Biomed Mater Res* 1997;35:391-397.
17. Nakaoka R, Tsuchiya T, Nakamura A. The inhibitory mechanism of gap junctional intercellular communication induced by polyethylene and the restorative effects by surface modification with various proteins. *J Biomed Mater Res* 2001;57:567-574.
18. Nakaoka R, Sakaguchi K, Tsuchiya T, Nakamura A. Studies on in vitro evaluation for the biocompatibility of various biomaterials: Inhibitory activity of various kinds of polymer microspheres on metabolic cooperation. *J Biomed Mater Res* 2001;57:279-284.
19. Mensil M, Krutovskikh V, Omori Y, Yamasaki H. Role of blocked gap junctional communication in non-genotoxic carcinogenesis. *Toxicol Lett* 1995;82/83:701-706.
20. Yamasaki H. Role of disrupted gap junctional intercellular communication in detection and characterization of carcinogens. *Mutat Res* 1996;365:91-105.
21. Sawada MS, Mano H, Hanada K, Kakudo S, Kameda T, Miyazawa K, Nakamaru Y, Yuasa S, Mori Y, Kumegawa M, Hakeda Y. Down-regulation of gap junctional intercellular communication between osteoblastic MC3T3-E1 cells by basic fibroblast growth factor and a phorbol ester (12-O-tetradecanoylphorbol-13-acetate). *J Bone Miner Res* 1997;12:1165-1173.
22. Lecanda F, Towler DA, Ziambaras K, Cheng SL, Koval M, Steinberg TH, Civitelli R. Gap junctional communication modulates gene expression in osteoblastic cells. *Mol Biol Cell* 1998;9:2249-2258.
23. Nakaoka R, Tsuchiya T. Biocompatibility of various kinds of polymer microspheres estimated from their effect on gap junctional intercellular communication of fibroblasts. *Mater Trans* 2002;43:3122-3127.
24. Wade MH, Trosko JE, Steindler M. A fluorescence photobleaching assay of gap junctional-mediated communication between human cells. *Science* 1986;232:525-528.
25. Ichikawa R, Tsuchiya T. A strategy for the suppression of tumorigenesis induced by biomaterials: Restoration of transformed phenotype of polyetherurethane-induced tumor cells by Cx43 transfection. *Cytotechnology* 2002;39:1-8.
26. Donahue HJ, Li Z, Zhou Z, Yellowley CE. Differentiation of human fetal osteoblastic cells and gap junctional intercellular communication. *Am J Physiol Cell Physiol* 2000;278:C315-C322.
27. Laing JG, Manley-Markowski RN, Koval M, Civitelli R, Steinberg TH. Connexin45 interacts with zonula occludens-1 and connexin43 in osteoblastic cells. *J Biol Chem* 2001;276:23051-23055.
28. Duffy SH, Delmar M, Spray DC. Formation of the gap junction nexus: Binding partners for connexins. *J Pathol Paris* 2002;96:243-249.
29. Jongen WMF, Fitzgerald DJ, Asamoto M, Piccoli C, Slaga TJ, Gros D, Takeichi M, Yamasaki H. Regulation of connexin 43-mediated gap junctional intercellular communication by Ca²⁺ in mouse epidermal cells is controlled by E-cadherin. *J Cell Biol* 1991;114:545-555.
30. Meyer RA, Laird DW, Revel JP, Johnson RG. Inhibition of gap junction and adherens junction assembly by connexin and A-CAM antibodies. *J Cell Biol* 1992;119:179-189.
31. Lauf U, Giepmans BNG, Lopez P, Braconnot S, Chen SC, Falk MM. Dynamic trafficking and delivery of connexins to the plasma membrane and accretion to gap junctions in living cells. *Proc Natl Acad Sci USA* 2002;99:10446-10451.

F.Watari T.Akazawa M.Uo T.Akasaka

Archives of BioCeramics Research

Volume 5



Asian BioCeramics Symposium 2005

Sapporo, JAPAN

***In vitro* study on the osteogenesis of normal human osteoblasts cultured on the discs of various kinds of calcium phosphate ceramics**

Masato Tamai^{1, a}, Ryusuke Nakaoka^{1, b} and Toshie Tsuchiya^{1, c}

¹Division of Medical Devices, National Institute of Health Science

1-18-1 Kamiyoga, Setagaya-ku, Tokyo 158-8501 Japan

^am-tamai@nihs.go.jp, ^bnakaoka@nihs.go.jp, ^ctsuchiya@nihs.go.jp

Keywords: Calcium phosphate ceramics, osteogenesis, cytotoxicity,

Abstract. We estimated effects of various CP ceramics on the properties of normal human osteoblasts (NHOst) as well as a viability of V79 fibroblasts. In the present study, five kinds of CP ceramics, namely, hydroxyapatite (HAp) fluorapatite (FAp), α -tricalcium phosphate (α -TCP), β -tricalcium phosphate (β -TCP) and tetracalcium phosphate (TTCP), were tested. Cytotoxicity test was carried out using V79 fibroblasts by colony assay system. The amounts differentiation level of NHOst was estimated from alkaline phosphatase (ALP) activity and osteocalcin. From the results of colony assay, FAp and α -TCP showed strong cytotoxicities on V79 cells. The results from the proliferation studies of NHOst with CP ceramics were consistent with the results of colony assay. In addition, the ALP activities of NHOst with CP ceramics after 1 week culture were significantly suppressed in comparison with that of NHOst alone. The osteocalcin amounts produced from NHOst cultured on β -TCP was the highest among five kinds of CP ceramics.

Introduction

Calcium phosphate (CP) ceramics have been studied to utilize as the scaffolds for repairing bone defects. For instance, hydroxyapatite ($\text{Ca}_{10}(\text{PO}_4)_6(\text{OH})_2$, HAp) or β -tricalcium phosphate ($\beta\text{-Ca}_3(\text{PO}_4)_2$, β -TCP), can be biologically bonded to natural bones and their porous materials are effective for restoration of bone defects [1]. Fluoroapatite ($\text{Ca}_{10}(\text{PO}_4)_6\text{F}_2$, FAp) has been reported to have a potential of novel bone repairing materials with high stability *in vivo*, since solubility of FAp is lower than that of HAp [2]. In addition, CP cement is also promising for bone repair and it is well known that α -tricalcium phosphate ($\alpha\text{-Ca}_3(\text{PO}_4)_2$, α -TCP) or tetracalcium phosphate ($\text{Ca}_4(\text{PO}_4)_2\text{O}$, TTCP) are starting materials for the harden reaction of the bone cement [3].

To develop biomaterials for utilizing for bone tissue, various properties, e.g. biological, physical or chemical property, should be satisfied. Among them, biological safety and osteogenesis properties, e.g. proliferation and differentiation of the osteoblasts, should be important factors to provided to the biomaterials. However, understandings of the biological interaction between osteoblasts and various CP ceramics are few, since the interaction has not been studied under the same experimental condition in detail. Therefore, we estimated effects of various CP ceramics on the properties of normal human osteoblasts (NHOst) as well as a viability of V79 fibroblasts in this study.

Materials and Methods

Materials

Cytotoxicity and osteogenesis of NHOst on five kinds of CP ceramics, namely, HAp, FAp, α -TCP, β -TCP and TTCP (Wako chem. Co. Ltd., Tokyo, Japan), were evaluated. 0.25g of CP powders was put into stainless mold and uniaxially pressed at 30MPa for 1 min to form pellets. The dimensions of the obtained CP pellet were 1mm in thickness and 12mm in diameter. CP pellets were sterilized by the autoclave 121°C for 20 min.

Cytotoxicity test on CP ceramics

Cytotoxicity test was carried out using Chinese hamster V79 lung fibroblasts by the colony assay system. V79 cells were maintained in Eagle's minimum essential medium (Nissui Pharmaceutical Co. Ltd.) with 10% fetal calf serum (FCS, Intergen company) and incubated at 37 °C in a humidified atmosphere with 5% CO₂.

The method of cell seeding was shown below; At first, each CP pellets were placed in each culture wells of 24 well culture plates (Corning Co. Ltd.) and 300µl of culture medium was added into each well. Next, 50 cells/300µl of culture medium was added into each well and incubated for 4 h at 37°C. Finally, 400µl of culture medium was added and incubated at 37 °C in a humidified atmosphere with 5 % CO₂ for 7days.

In order to investigate the cell adhesive property on the CP ceramics, the culture medium was changed after cultivations for 4 h and incubated for 7days. The removed culture medium was transferred to another well of the plate and incubated for 7days as well.

Cytotoxicity of extracts from CP ceramics was also investigated in this study. Suspensions of CP ceramics in the culture medium (100mg/mL) were stirred at 37°C for 3days in 150rpm. The suspensions were centrifuged and the supernatants were collected to use as test extracts. The cytotoxicity test was carried out culturing 50 V79 cells in 1ml of the extracts and incubated at 37 °C for 7days.

After 7days, the cells were fixed in methanol and the number of the V79 colonies was counted after staining cells with 5%-Giemsa solution. In addition, the pH of the medium after 7-days culture was measured to estimate effect of the pH of the medium on the cytotoxicity test.

Osteogenesis evaluation of NHOst cultured on CP ceramics

NHOst were purchased from BioWhittaker Inc.(Walkersville,MD). The NHOst were maintained in alpha minimum essential medium (αMEM, Gibco, Grand Island, NY) containing 10%-FCS. incubators at 37 °C in a humidified atmosphere with 5% CO₂. All assays were performed using αMEM containing 10%-FCS supplemented with 10mM beta-glycerophosphate. Similar to the method of the cytotoxicity test, each CP pellets were placed in 24-well culture plates (Corning Co. Ltd.) and 300µl of culture medium was added into each well, followed by addition of 1ml of cell suspension (4×10^4 cells/ml) into each well.

Proliferation of NHOst cells cultured on various kinds of CP ceramics was estimated by Tetracolor One assay (Seikagaku Co., Ltd. Tokyo, Japan), which incorporates an oxidation reduction indicator based on detection of metabolic activity. After 7-days incubation, 2%-TetraColor One/αMEM solution was added to each well, followed by 2h incubation. The absorbance of the supernatant at 450nm was estimated using µQuant spectrophotometer (Bio-tek Instrument, Inc., Winooski, VT). After estimating the proliferation, the cells were washed by phosphate-buffered saline (PBS(-)), followed by addition of 1ml of 0.1M glycine buffer (pH=10.5) containing 10mM MgCl₂, 0.1mM ZnCl₂ and 4mM p-nitrophenylphosphate sodium salt. After incubating at room temperature for 5min, the absorbance of 405 nm of glycine buffer was detected using µQuant spectrophotometer to evaluated alkaline phosphatase (ALP) activity of the test cells. The amount of Osteocalcin produced by NHOst was evaluated using Gla-type Osteocalcin EIT kit (Takara. Co., Ltd.). The structural change of CP before and after autoclave sterilization or culture were investigated by powder X-ray diffraction (XRD) analysis and scanning electron microscopy(SEM). XRD analysis was carried out (Rigaku Co., Ltd. / RINT 2000) with the CuK_α radiation at 40kV, 50mA. SEM observations were performed (JEOL / JSM-5800LV) with an accelerating voltage of 25kV.

Results

Cytotoxicity of various CP ceramics

The results of the cytotoxicity test of CPs are summarized in table 1. Notably, the colonies were hardly formed on FAp and α -TCP pellets and the ratios of the colony formation against V79-alone culture were 22.6% and 0.0%, respectively. In addition, the ratios of the colony formation on the HAp, β -TCP and TTCP pellets were 58.1%, 57.3% and 78.4%, respectively. From these results, it is suggested that V79 cells were viable and adhered on the pellet after for 4h after seeding despite of the type of CP ceramics, irrespective of the type of CP ceramics. On the other hand, the cytotoxicity test of extracts from CPs revealed that the tendency of their cytotoxicity was almost the same as that of the respective CP pellets themselves (table1).

Proliferation and differentiation of NHOst cultured on CP ceramics

The effects of various kinds of CP ceramics on the osteogenesis of NHOst are represented in table2. The effects of the CPs on proliferation were consistent with those on the colony formation. Similar to the cytotoxicity test, the proliferation of NHOst was inhibited on FAp and α -TCP pellets. ALP activities of NHOst on CP ceramics after 7-days culture were significantly suppressed in comparison with that of NHOst alone. On the other hand, the osteocalcin amounts produced from NHOst were influenced by the type of CP ceramics. NHOst on β -TCP showed the highest Osteocalcin production among five kinds of CP ceramics.

4. Discussion

The fact that less formation of colonies was observed on FAp and α -TCP pellets suggests that they are strongly cytotoxic. It is suggested that the differences in the colony formation on various CP pellets are ascribed to difference in extract properties from the CP related with the composition or crystal structure (table1). In addition, proliferation of NHOst also was inhibited on FAp and α -TCP. The pH values of culture medium after incubation for 7 days are shown in table1. As shown in the table, the pH of culture medium after incubation with FAp pellets is almost the same as that of HAp, while the pH of the α -TCP medium is much lower than other CP ceramics. In order to considering the reason of the low pH of the culture medium with α -TCP pellet, a surface structural change of α -TCP before and after incubation was analyzed by SEM. SEM images of α -TCP after extraction treatment are shown in Fig.1.

Table1. Cytotoxicity test of various CP ceramics.

Samples	Composition	Formation of colony		pH of medium after culturing	Ca concentration ¹⁾ /ppm
		On pellets /%	Extraction / %		
V79 alone	-	100.0±4.5	100.0±13.9	7.12	-
HAp	Ca ₁₀ (PO ₄) ₆ (OH) ₂	58.1±12.8	84.6±15.1	7.24	0.19
FAp	Ca ₁₀ (PO ₄) ₆ F ₂	22.6±20.9**	26.9±8.6*	7.20	0.17
α -TCP	α -Ca ₃ (PO ₄) ₂	0.0*	7.6±5.1*	6.76	72.62
β -TCP	β -Ca ₃ (PO ₄) ₂	57.3±6.9	81.1±19.3	7.40	1.27
TTCP	Ca ₄ (PO ₄) ₂ O	78.2±5.0	93.7±6.8	7.65	0.58

* p <0.01 against V79 alone, ** p <0.05 against V79 alone, 1)The Ca ions concentration was extracted Ca ions from CP-ceramics in PBS(-), which were measured by inductivity coupled plasma-atomic emission spectroscopy.

Table2. Osteogenesis of NHOst cultured on various kinds of CP ceramics.

Samples	Proliferation / %	Differentiation level	
		ALP activity / %	Osteocalcin / %
NHOst alone	100±7.9	100±4.4	100±46.2
HAp	63.2±3.5	20.4±1.8*	81.1±31.0
FAp	42.9±19.5	1.24±0.3*	47.2±20.7
α -TCP	18.3±2.5	17.9±3.8*	110.7±18.8
β -TCP	56.0±4.7	6.3±3.2*	177.1±78.4**
TTCP	82.3±27.3	17.5±4.6*	114.8±4.0

* p <0.01 against NHOst alone, ** p <0.01 against HAp

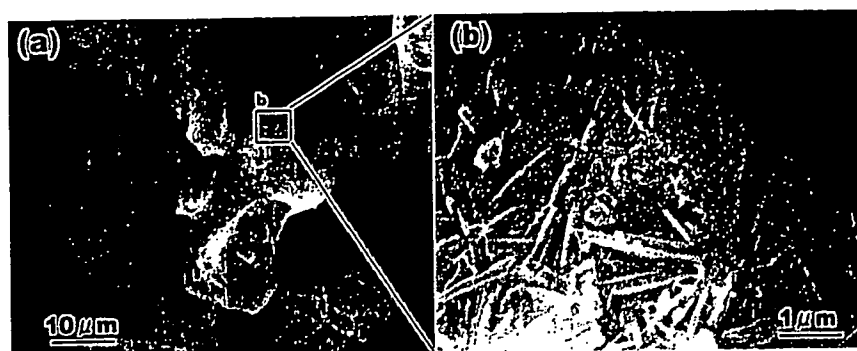
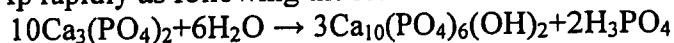

Fig.1. SEM images of α -TCP after extract treatment. (a) whole image and (b) enlarged image of the area enclosed by a rectangle in (a)

Before the extraction, a particle size of α -TCP was about $10\mu\text{m}$ and its surface was smooth. However, as shown in Fig.1, whisker-like precipitates of $1\text{-}2\mu\text{m}$ in length and $2\text{-}300\text{nm}$ in width are observed at the surface of α -TCP after the extraction, although there is no change in its particle size. It is well known that slightly water-soluble calcium phosphates convert to HAp in aqueous solution with high pH value. Since the solubility of α -TCP is higher than that of other calcium phosphates, the α -TCP converts to HAp rapidly as following the reaction.



According to the report of this conversion [4], HAp produced by the above reaction has whisker-like morphology. Therefore, the whisker-like precipitates can be regarded as HAp, so that it is considered that the above conversion occurs at the surface of the α -TCP during incubation. In this case, phosphoric acid is produced as a byproduct in the conversion reaction and the phosphoric acid caused the decrease in the pH of solution. Morita and co-workers [5] have reported that low pH itself could be clastogenic to mammalian cells and the pH of 50% V79 cell survival was 6.5 for 24h incubation. Therefore, it is suggested that the cytotoxicity of α -TCP was mainly due to the pH decreasing resulting from an increase of the phosphoric acid ion produced by the hydrolysis conversion from α -TCP to HAp.

On the other hand, FAp has the same crystal structure of HAp but the hydroxyl ions in HAp substituted by fluorine ions. Since difference of the colony formation on various CP ceramics would be due to eluted substances from CP as described above, the cytotoxicity of FAp would be due to eluted fluoride ions from FAp.

Effects of CP ceramics on osteogenesis function of NHOst are shown in table2. As shown in the table, ALP activities of NHOst were significantly suppressed on CP ceramics irrespective of their type and the amount of osteocalcin on β -TCP was the highest among five kinds of CP ceramics. Since it is well known that osteocalcin express in matured stage of differentiation level of NHOst, these results suggest that maturation of NHOst proceeds on β -TCP. The differences of maturation of NHOst on various kinds of CP ceramics may be related with the amount of extracted Ca^{2+} and/or PO_4^{3-} ions.

References

- [1] Y. Ito, N. Tanaka, Y. Fujimoto, Y. Yasunaga, O. Ishida, M. Agung, M. and Ochi, J. Biomed. Mater. Res: Vol.69A(3) (2004) p454
- [2] K. Cheng K, W. Weng, H. Qu, P. Du, G. Shen, G. Han, J. Yang and M. J. Ferreira: J.Biomed. Mater. Res. B, Vol.69(1) (2004) p33
- [3] M. E. Ooms, J. G. C. Wolke, J. C. P. M. Waerden and J. A. Jansen, Trabecular, J.Biomed. Mater. Res. Vol.61 (2002) p9
- [4] M.Tamai, T.Isshiki, K.Nishio, M.Nakamura, A.Nakahira and H.Endoh: J. Mater. Res. Vol.18 (2003), p.2633
- [5] T.Morita, T.Nagaki, I.Fukuda and K.Okumura: Muta. Res. Vol.268 (1992), p.297



The response of normal human osteoblasts to anionic polysaccharide polyelectrolyte complexes

Misao Nagahata^{a,b,1}, Ryusuke Nakaoka^{a,1,*}, Akira Teramoto^b,
Koji Abe^b, Toshie Tsuchiya^a

^aDivision of Medical Devices, National Institute of Health Sciences, 1-81-1 Kamiyoga, Setagaya-ku, Tokyo 158-8501, Japan

^bDepartment of Functional Polymer Science, Faculty of Textile Science and Technology, Shinshu University, Ueda 386-8567, Japan

Received 10 September 2004; accepted 7 January 2005

Abstract

Polyelectrolyte complexes (PEC) were prepared from chitosan as the polycation and several synthesized functional anion polysaccharides, and their effects on cell attachment, morphology, proliferation and differentiation were estimated using normal human osteoblasts (NH₂Ost). After a 1-week incubation, PEC made from polysaccharides having carboxyl groups as polyanions showed low viability of NH₂Ost on it although the NH₂Ost on it showed an enhancement in their differentiation level. On the other hand, NH₂Ost on PEC made from sulfated or phosphated polysaccharides showed similar attachment and morphology to those on the collagen-coated dish. When the number of NH₂Ost was estimated after 1 week, the number on the PEC was ranged from 70% to 130% of those on the collagen-coated dish, indicating few effects of these PEC on cell proliferation. In addition, NH₂Ost on PEC films made from sulfated polysaccharides differentiated to a level very similar to that observed on the collagen-coated dish, indicating that these PEC films maintain the normal potential of NH₂Ost to both proliferate and differentiate. Measurement of gap junctional intercellular communication of NH₂Ost on PEC revealed that PEC did not inhibit communication, suggesting that PEC films have few effects on cell homeostasis. Thus, PEC made from the sulfated polysaccharide may be a useful material as a new scaffold for bone regeneration.

© 2005 Elsevier Ltd. All rights reserved.

Keywords: Polyelectrolyte complex; Normal human osteoblasts; Cell proliferation; Cell differentiation; Gap junctional intercellular communication

1. Introduction

The extracellular matrix (ECM) provides an essential three-dimensional (3D) environment for cells to construct several kinds of tissues. The ECM, consisting of numerous kinds of molecules such as proteins, polysaccharides and proteoglycans regulates the behavior of surrounding cells to form tissues and organs precisely [1,2]. For tissue regeneration trials using *in vitro*

techniques, therefore, it is indispensable to develop a synthetic ECM scaffold that functions similarly to the native ECM. For more than a decade, engineering of new tissues by using selective cell transplantation on polymer scaffolds as an artificial ECM instead of tissue transplantation to other living bodies has been studied [3,4]. Recently, many studies on developing a scaffold for tissue regeneration have been done using ECM proteins such as collagen and gelatin [5–7], biodegradable synthetic polymers [8–10] and polysaccharides [11,12]. Because proteins derived from human tissues have many problems such as antigenicity or potential for infection, a biocompatible synthetic polymer or polysaccharide may be preferable for tissue regeneration.

*Corresponding author. Division of Medical Devices, National Institute of Health Sciences, 1-18-1 Kamiyoga, Setagaya-ku, Tokyo 158-8501, Japan. Tel.: +81 3 3700 9264; fax: +81 3 3707 6950.

E-mail addresses: nagahata@nihs.go.jp (M. Nagahata), nakaoka@nihs.go.jp (R. Nakaoka).

¹These authors contributed equally to this work.

A polyelectrolyte complex (PEC) is a compound made from an electrically neutralized molecular complex of polyanions and polycations [13]. PEC can be prepared in various forms such as a film (2D) and a hydrogel, a microcapsule or a sponge (3D), which can be used as a scaffold in tissue regeneration studies. The effects of PEC films composed of polysaccharides on cell behavior have been studied, and we have already reported that PEC can stimulate differentiation of osteoblasts and periodontal ligament fibroblasts [14–16]. These studies suggest that PEC can be used as a biomaterial for repairing or regenerating tissues. In addition, because the PEC are composed of polysaccharides, PEC is expected not to elicit immune responses against it and to have better biocompatibility with the human body, although this is yet to be proved. Therefore, it is necessary to study the interactions between PEC and cells, especially human-derived, to clarify the usefulness of PEC as a biomaterial.

In this study, normal human osteoblasts (NHOst) were cultured on various PEC prepared on a tissue culture plate from chitosan as the polycation and modified chitins or hyaluronan as the polyanion. It should be generally agreed that estimating not only functional advantages but also safety and biocompatibility of biomaterials is important to develop them for clinical use, but the latter is not always studied. Therefore, we measured changes in gap junctional

intercellular communication (GJIC) as well as the cell number and differentiation. GJIC is very important function for almost all cells to maintain their homeostasis [17]. During this decade, we have studied the effects of model biomaterials on the GJIC of cells cultured on them and suggested a possibility that changes in the GJIC can be used as an index of biocompatibility of biomaterials [18–21]. Therefore, we measured changes in GJIC of NHOst on PEC in order to estimate the biocompatibility of PEC from their effects on these cell functions.

2. Materials and methods

2.1. Chemicals

Fig. 1 shows the chemical structures of the polyanions and the polycation. Chitosan as the cationic polysaccharide and carboxymethylated chitin [CM-Chitin: degree of substitution (DS) = 1.0 (1.0 anionic site/saccharide ring)] were purchased from Katokichi Co., Ltd. (Kagawa, Japan). Sulfated chitin (S-Chitin: DS = 1.5), phosphated chitin (P-Chitin: DS = 1.6), hyaluronan (HA), and sulfated hyaluronan (SHA: DS = 1.05) were prepared as previously reported [14–16,22].

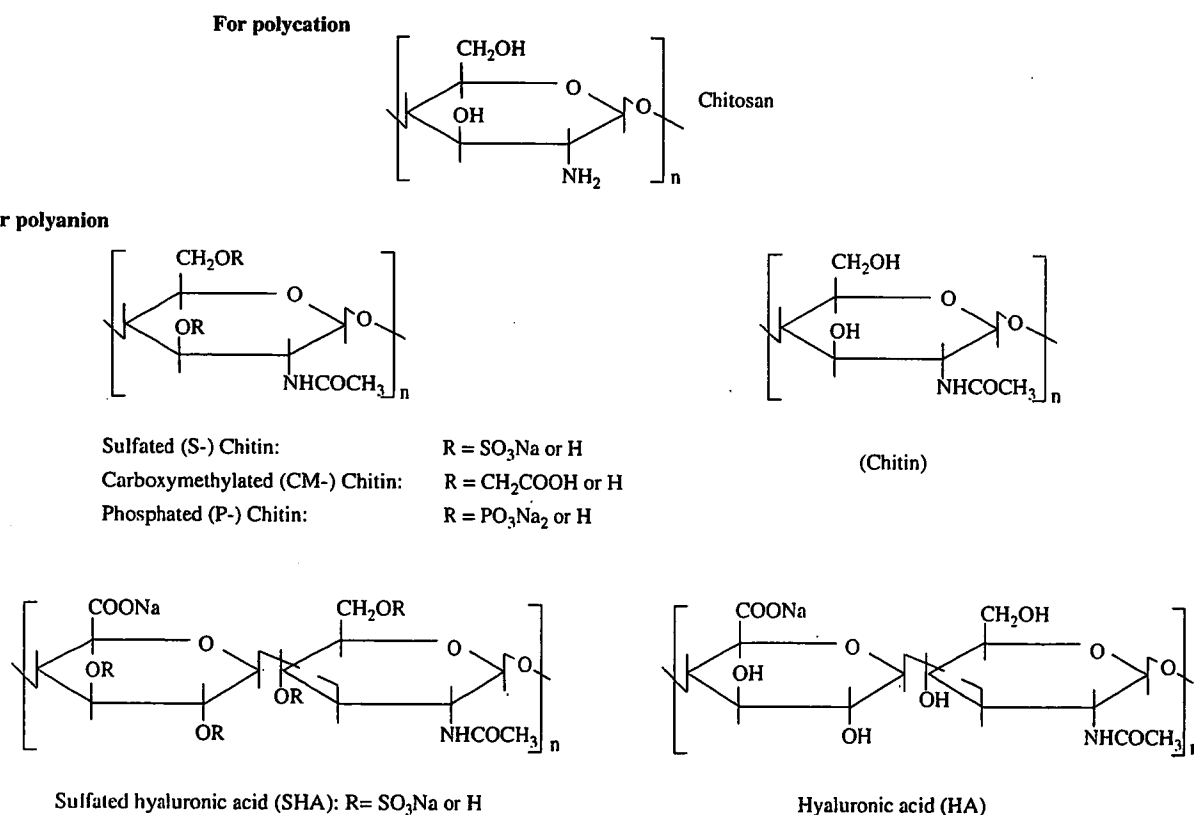

Fig. 1. Polymers for polyelectrolyte complex (PEC) in this study.

2.2. Preparation of PEC and PEC-coated dishes

Polyanions were dissolved individually in distilled water (final concentration = 5×10^{-4} mol of ionic sites/l), and the pH of the solutions was adjusted to 7.4 by adding aqueous HCl or NaOH. Chitosan was dissolved in aqueous 0.5% acetic acid solution and the pH adjusted to 6.0. The ratio of the solutions of polyanions and polycation was adjusted in each combination to neutralize the charge balance of PEC. This mixed solution (1 ml/35 mm tissue culture dish) was allowed to stand overnight at room temperature. After removing the supernatant solution, the dish was dried and annealed at 65 °C in an oven. Then, the dishes were washed with distilled water and oven-dried again to form the PEC-coated dish. This dish was sterilized for 3 min in a microwave oven. Water contact angles of PEC films were measured with the sessile drop method [23], and their zeta potentials were measured by Otsuka Electronics Co., Ltd. (Osaka, Japan).

2.3. Cell culture

NH0st were purchased from BioWhittaker Inc. (Walkersville, MD). The standard culture of NH0st was performed using alpha minimum essential medium (Gibco, Grand Island, NY) containing 20% fetal calf serum (FCS) (Kokusai Shiyaku Co., Ltd., Tokyo Japan). The cells were maintained in incubators under standard conditions (37 °C, 5% CO₂–95% air, saturated humidity). All assays were performed using alpha minimum essential medium containing 20% FCS, supplemented with 10 mM beta-glycerophosphate. NH0st cells (1×10^5 cells/dish/2.5 ml medium) were cultured on PEC-coated dishes to evaluate the effects of their interaction with PEC. In each experiment, the medium was changed three times before GJIC of the cells was measured and their differentiation level was evaluated after a 1-week incubation.

2.4. Estimation of differentiation level of NH0st cultured on PEC films

The proliferation of NH0st cells cultured on PEC films was estimated by Tetracolor One assay (Seikagaku Co., Tokyo, Japan), which incorporates an oxidation-reduction indicator based on detection of metabolic activity. After a 1-week incubation, 20 µl of Tetracolor One solution was added to each test dish, followed by a further 2 h incubation. The absorbance of the supernatant at 450 nm was estimated by µQuant spectrophotometer (Bio-tek Instruments, Inc., Winooski, VT). Estimation of alkaline phosphatase (ALP) activity was performed according to an original procedure by Ohyama et al. [24]. After estimating the proliferation of the NH0st cells cultured on PEC films, the cells were

washed by phosphate-buffered saline (PBS(-)), followed by addition of 1 ml of 0.1 M glycine buffer (pH 10.5) containing 10 mM MgCl₂, 0.1 mM ZnCl₂ and 4 mM *p*-nitrophenylphosphate sodium salt. After incubating the cells at room temperature for 7 min, the absorbance of the glycine buffer was detected at 405 nm using µQuant to evaluate the ALP activity of the test cells. The amounts of calcium deposited by the cell during a 1-week incubation were evaluated as follows: after fixing the cells in PBS(-) containing 3% formaldehyde and washing the cells with PBS(-), 0.5 ml of 0.1 M HCl was added to each well. The amounts of calcium dissolved in HCl were estimated using a calcium detecting kit (Calcium-C test Wako, Wako, Osaka, Japan) according to manufacturer's instruction.

2.5. Measurements of GJIC activity

NH0st cultured on PEC films were subjected to fluorescence recovery after photobleaching (FRAP) analysis to estimate the inhibitory activity of these films on the GJIC. FRAP analysis was carried out according to the procedure of Wade et al. [25] with some modifications [21]. Briefly, NH0st were plated on PEC-coated dishes and incubated for 1 or 7 days. The cells were incubated for 5 min at room temperature in PBS(-) containing Ca²⁺ and Mg²⁺ (PBS(+)) and a fluorescent dye, 5,6-carboxyfluorescein diacetate. After washing off excess extracellular dye with PBS(+), the cells in PBS(+) contacting at least two other cells were subjected to FRAP analysis under a Ultima-Z confocal microscope (Meridian Instruments, Okemos, MI) with a 10 × objective lens at room temperature. The cells were photobleached with a 488 nm beam, and recovery of fluorescence intensity was subsequently monitored at 1-min intervals for a total of 4 min. The data obtained from more than seven independent cells were expressed as the average ratio of the fluorescence recovery rate to the rate obtained from NH0st cultured on a collagen-coated dish.

2.6. Statistic analysis

All data were expressed as mean values ± standard deviation of the obtained data. The Fisher–Tukey criterion was used to control for multiple comparisons and to compute the least significant difference between means.

3. Results and discussion

When NH0st were cultured on five kinds of PEC films, their morphology and attachment to the film differed with the composition of the PEC. Fig. 2 shows the morphologies of the NH0st adhering to PEC films.

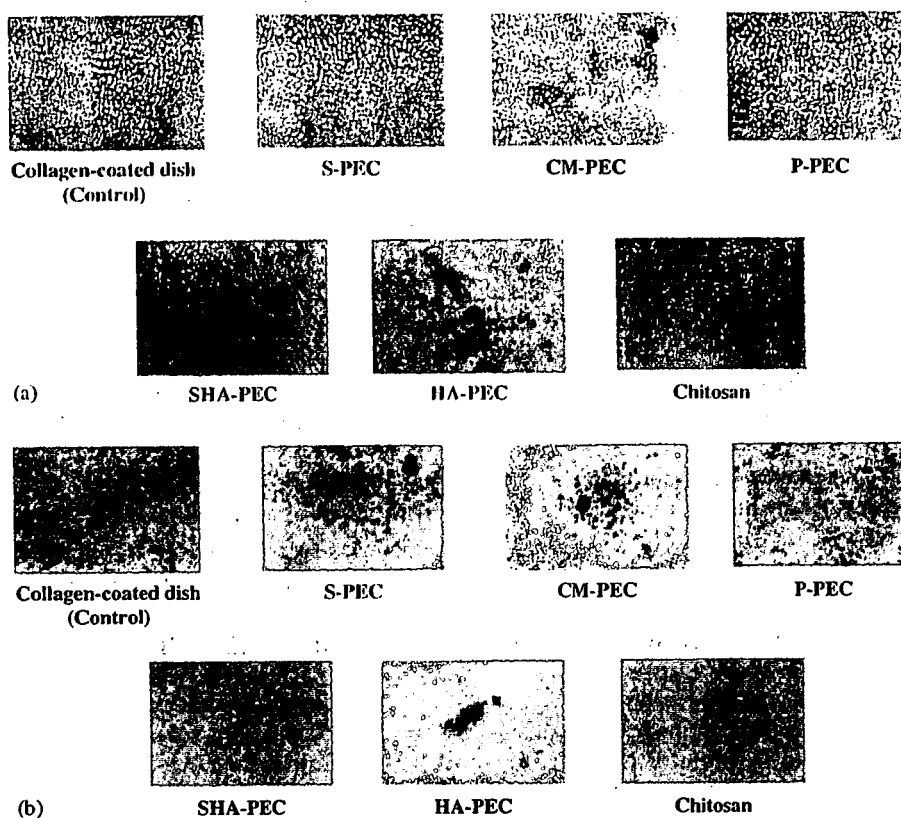

Fig. 2. Light micrographs of normal human osteoblasts (NHOst) on various PEC films after a 2-day incubation: (a) and 1-week incubation, (b). (Original magnification: $\times 100$).

After 2-day incubation, the NHOst on PEC composed of chitosan and either sulfated chitin (S-PEC) or sulfated hyaluronan (SHA-PEC) showed morphologies similar to those on a normal culture plate. When cells were cultured on PEC of chitosan and phosphated chitin (P-PEC), some of them formed small aggregates, while the rest showed morphologies similar to those on S-PEC and SHA-PEC. On the other hand, NHOst cultured on PEC from chitosan and either carboxymethyl chitin (CM-PEC) or hyaluronan (HA-PEC) did not adhere well and showed aggregation. Similar morphologies of the cells on the PEC were observed after 1 day of incubation (data not shown). Even after 1 week of incubation, the morphologies and attachment of the cells on the PEC films did not change (Fig. 2). Only cells grown on cationic polysaccharide chitosan-coated culture dishes preserved morphology of very similar to NHOst grown on collagen-coated cultured dishes, indicating that these morphological differences are ascribable to differences in the anionic polysaccharides of which the PEC is composed.

It has been reported that cell attachment, morphology, and response are influenced by physico-chemical properties of the material surface [23,26]. To clarify what properties of PEC control the attachment and morphology of the cell, the contact angle and zeta

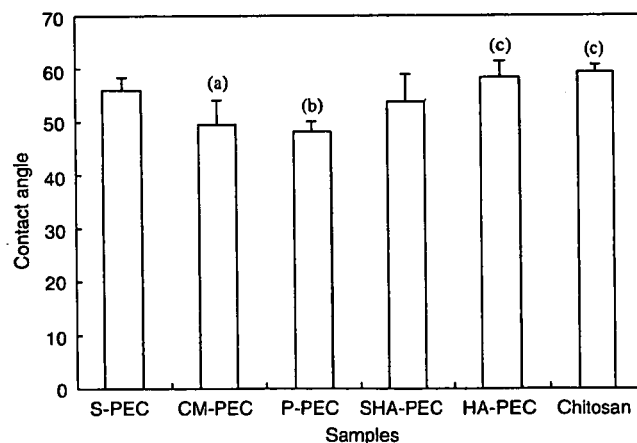

Fig. 3. Contact angles of PEC films studied: (a) $p < 0.05$ against S-PEC, (b) $p < 0.01$ against S-PEC, (c) $p < 0.01$ against both CM-PEC and P-PEC.

potential of PEC films were estimated. Although their compositions are different, large differences in their contact angles were not observed (Fig. 3). On the other hand, a measurement of zeta potentials of the PEC showed interesting results (Table 1). The measurement revealed that S-PEC and SHA-PEC have negative zeta potentials, whereas PEC films made of polysaccharides

Table 1
Zeta potentials of various PEC prepared on a culture dish

	Culture	S-PEC	CM-PEC	P-PEC	SHA-PEC	HA-PEC
Zeta potential (mV)	-58.7	-28.0	34.5	24.9	-5.7	29.5

Table 2
The cell number and differentiation of NHOst cultured on various PEC films after 1 week

Samples	The cell number (percent against control)	$\frac{\text{ALP activity}}{\text{The cell number}}$ (ratio)	$\frac{\text{Ca amount}}{\text{The cell number}}$ ($\mu\text{g}/\text{ratio}$)
Collagen-coated dish	100.0 \pm 17.0	1.00 \pm 0.15	3.4 \pm 0.5
S-PEC	82.2 \pm 6.1	0.98 \pm 0.11	10.7 \pm 3.6
CM-PEC	6.0 \pm 2.6*	0.05 \pm 0.08*	27.4 \pm 3.0*
P-PEC	130.4 \pm 6.3	0.02 \pm 0.01*	2.5 \pm 0.8
SHA-PEC	71.4 \pm 22.1	1.35 \pm 0.48	2.1 \pm 1.0
HA-PEC	8.1 \pm 3.0*	0.52 \pm 0.31	38.3 \pm 12.3*
Chitosan	79.5 \pm 25.0	0.93 \pm 0.13	2.7 \pm 2.0

* $p < 0.01$ against collagen-coated dish.

with a carboxyl group, such as HA-PEC and CM-PEC, showed positive zeta potentials. In addition, P-PEC showed a positive potential less than that of HA-PEC. These data indicate that attachment of NHOst on surfaces with positive zeta potentials is reduced, suggesting the zeta potential of a PEC film partially controls cell attachment and morphology. Although all PEC were prepared by mixing anionic and cationic polysaccharides to neutralize their charge, zeta potential of each PEC film was ranged from -30 to 35 mV as shown in the table. This might indicate that not all anionic and cationic chemical groups were interacted to make PEC and their main chain composition and type of chemical groups may influence their side chain mobility, resulting in different surface zeta potential of each PEC. Details of surface properties of PEC films and their relationship to cell attachment will be reported in the near future.

After 1-week of incubation on various PEC films, the differentiation level of NHOst was estimated by measuring proliferation, alkaline phosphatase (ALP) activity and the amounts of calcium deposited. Table 2 shows the proliferation and ALP activity of NHOst cultured on various PEC films as well as the amounts of calcium deposited on the PEC. The proliferation of NHOst on the PEC is expressed as a percentage of proliferation of NHOst on a normal culture dish. The ALP activity was also calculated as a percentage of the control and normalized using the results of proliferation. In addition, the amount of calcium detected was normalized using the proliferation results as well. After a 1-week incubation, many dark spots, presumably calcium deposits, were observed on the collagen-coated dish and other PEC films (Fig. 2). When NHOst were

cultured on CM-PEC or HA-PEC, it was observed that the NHOst aggregates were covered by the calcium deposits. It was reported that a surface with carboxyl group could induce calcium deposition after its incubation in simulated body fluid [27]. However, when the PEC were incubated in the medium without NHOst, no calcium deposition was detected. In addition, zeta potential estimation suggests less carboxyl groups are appeared on a surface of the PEC. These indicate that calcium deposition occurred only on aggregated NHOst but not on surfaces lacking NHOst. Therefore, normalization is necessary to estimate the capacity of PEC films to induce NHOst differentiation, although the raw values of deposited calcium or ALP activity are low. In fact, CM-PEC or HA-PEC films show a capacity to induce NHOst differentiation comparable to the collagen-coated dish and other PEC films, judging from the normalized values of deposited calcium shown in the table, even though the ratio of NHOst number on them was only 6–8% of that on a collagen-coated dish. Their ALP activities were, however, much lower than those on the collagen-coated dish. Incubation of the PEC films without NHOst for 1 week resulted in no calcium deposition, irrespective of their composition, suggesting that the PEC films themselves had no effect on calcium deposition. Thus, enhancement of calcium deposition on the PEC films may be ascribed to enhancement of NHOst functions related to their differentiation even though their ALP activity was suppressed. The reason for this inconsistency observed between calcium deposition and ALP activity must be investigated further.

When sulfated polysaccharides were used to prepare PEC films, proliferation of NHOst on the PEC films was 70–80% of that on a collagen-coated dish, and ALP

activity was very similar to that on the collagen-coated dish. This suggests that sulfated polysaccharide PEC does not affect NHOst functions. Actually, there were no statistical differences in the amounts of calcium deposited between NHOst on the PEC and the collagen-coated dish although NHOst on S-PEC showed higher average calcium deposition. Thus, it is suggested that the PEC films made from sulfated polysaccharides are comparable substrates to a collagen-coated dish for cell culture. When compared to a normal culture dish, it has been reported that S-PEC can induce aggregation of cultured human fibroblasts and enhance their DNA synthesis in an earlier stage of cell culture by activation of the ERK pathway [28]. Since we used a collagen-coated dish as a control in this study, it is expected that the pathway of NHOst on the dish may be already activated through integrin molecules on the NHOst membrane. Therefore, the results in this study suggest the PEC from sulfated polysaccharides have a potential to proliferate and differentiate NHOst very similar to that of collagen.

To assess the effects of PEC films on cell function, gap junctional intercellular communication (GJIC), which is an important function of cells for maintenance of homeostasis [17], of NHOst on the films were measured. As shown in Fig. 4, GJIC of NHOst on PEC films did not show statistically significant differences compared to those grown on a collagen-coated dish. Although the GJIC of NHOst on CM-PEC showed a decrease after 1 day of incubation, it had recovered after 1 week. This result suggests that most PEC films have the potential to maintain homeostasis of attached cells although they showed different influences on the number and the

differentiation of NHOst. On the other hand, NHOst on chitosan, which was used as the polycation for all PEC, showed suppression of GJIC after 1 week. This suggests that chitosan disturbs homeostasis maintenance of NHOst, but improve its biocompatibility by forming PEC films with other anionic polysaccharides. Therefore, PEC might be used as a biocompatible material for medical devices and tissue engineering scaffolds.

4. Conclusion

PEC films composed of various polysaccharides were prepared, and their effects on NHOst functions were evaluated. Attachment, morphology, growth and differentiation of NHOst were influenced by the composition of the PEC on which they were grown. NHOst attachment decreased and their aggregates were observed on PEC prepared from polysaccharides containing a carboxyl group (CM- and HA-PEC). ALP activity of NHOst was suppressed on these PEC films although calcium deposition was observed more frequently than on other PEC films. In addition, these PEC films strongly suppressed proliferation of NHOst. PEC prepared from phosphated chitin and chitosan (P-PEC) showed low ALP activity and calcium deposition, although the number of NHOst was highest after 1-week incubation. These indicate unsuitability of these three PEC for usage in tissue engineering. On the other hand, NHOst adhered to and proliferated well on PEC films when sulfated polysaccharides were used as the polyanion (S- and SHA-PEC). Moreover, these PEC films showed almost the same suitability as the collagen-coated dish in all cell functions studied, indicating that these PEC films, especially S-PEC can be used as a scaffold for bone regeneration. Further studies, especially in vivo studies, are needed to clarify the usefulness of PEC films for tissue engineering.

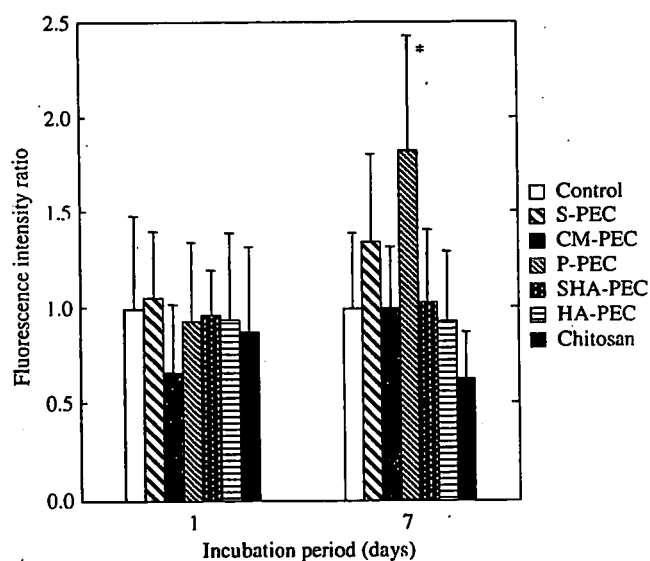

Fig. 4. Gap junctional intercellular communication activity of NHOst on various PEC films estimated by FRAP analysis technique. (* $p < 0.01$ against control).

Acknowledgements

This work was partially supported by Health and Labour Sciences Research Grants for Research on Advanced Medical Technology and Risk Analysis Research on Food and Pharmaceuticals by Ministry of Health, Labour and Welfare, Health and Labour Sciences Research Grants for Research on Health Sciences focusing on Drug Innovation by the Japan Health Sciences Foundation, and Grant-in-Aid for 21st Century COE Program "Advanced Fiber Engineering" and Grant-in-Aid for Scientific Research (B), 2002 (14350495) by Ministry of Education, Science, Sports and Culture.