

図A群

在院日数、総点数、包括範囲総点数、包括範囲一日点数

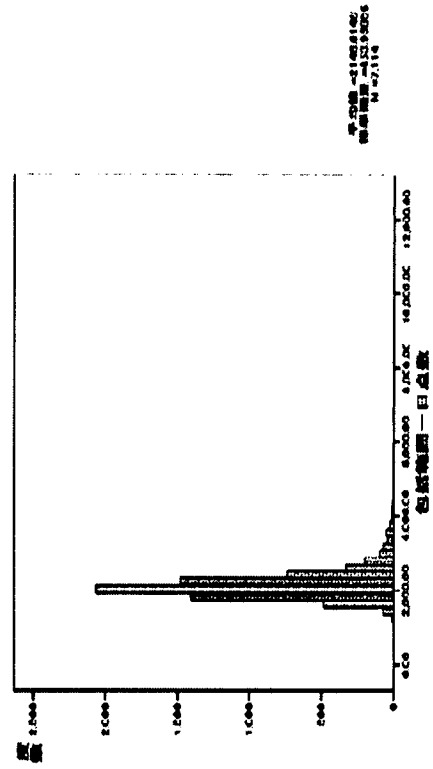

図B群(基本DPC)

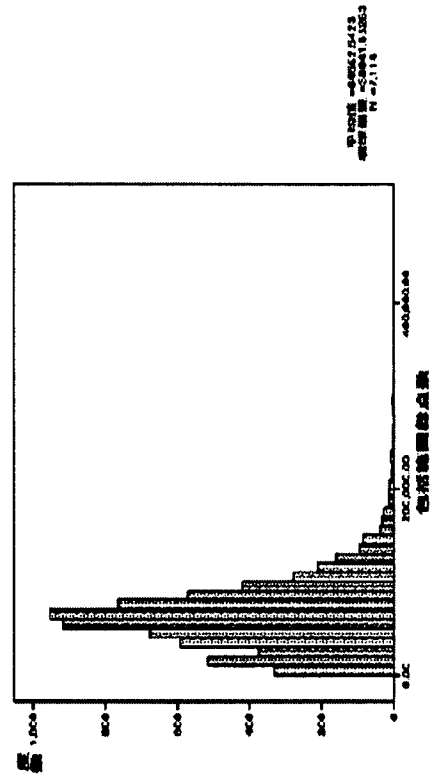
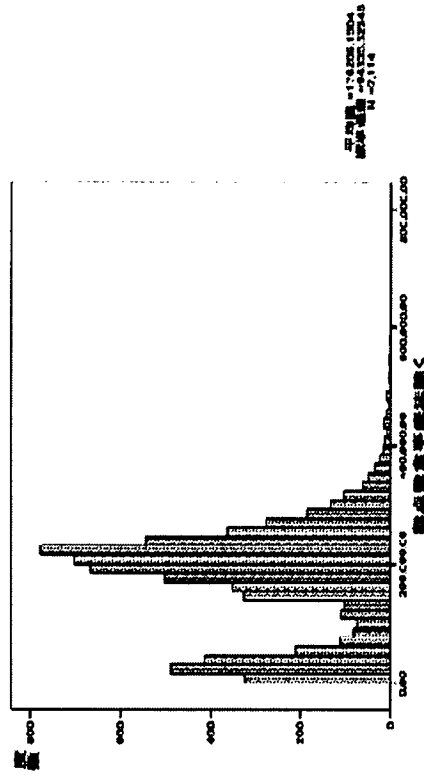
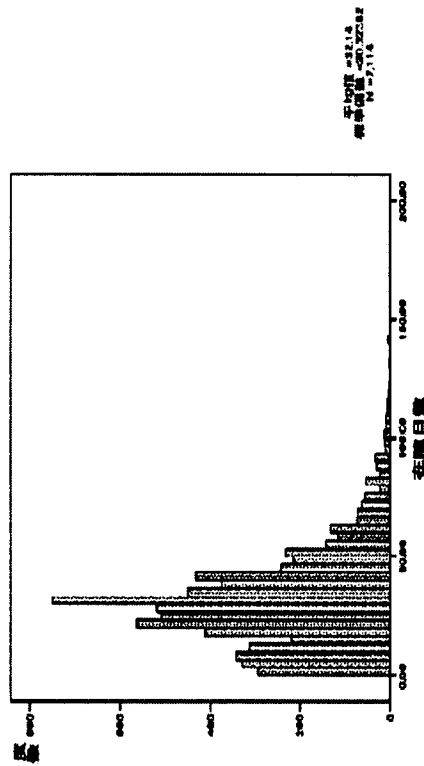
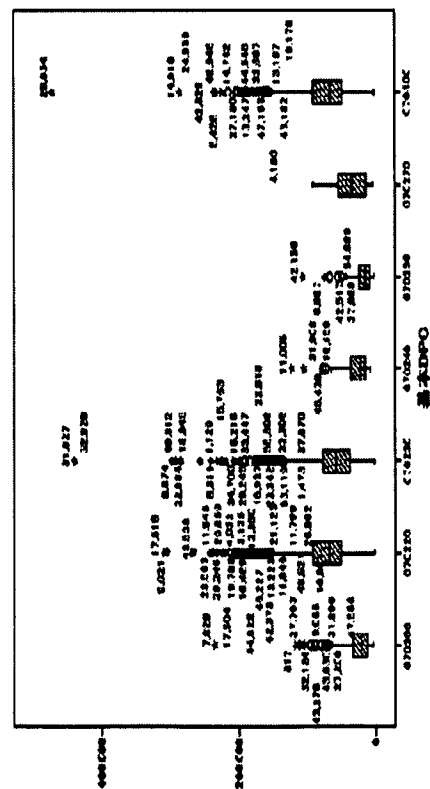
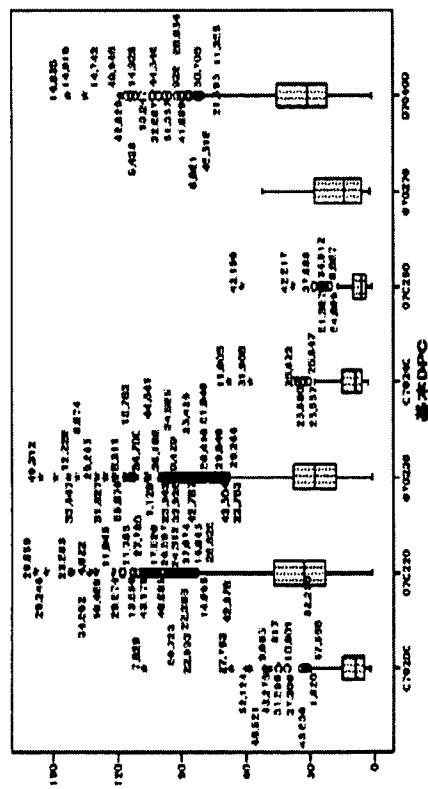
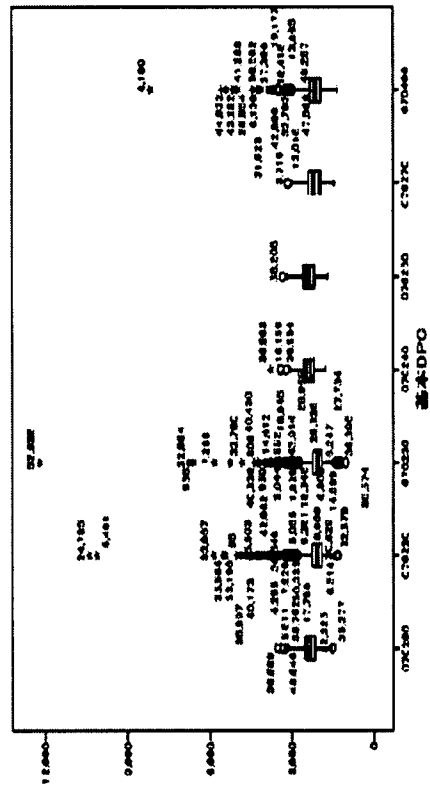
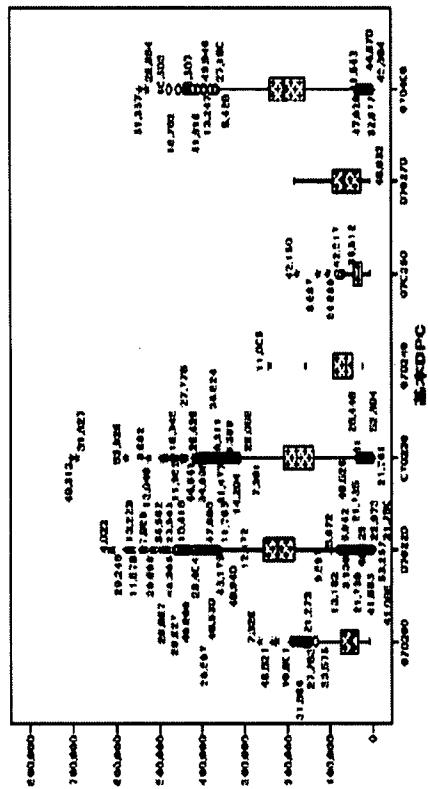

図B群(年度)

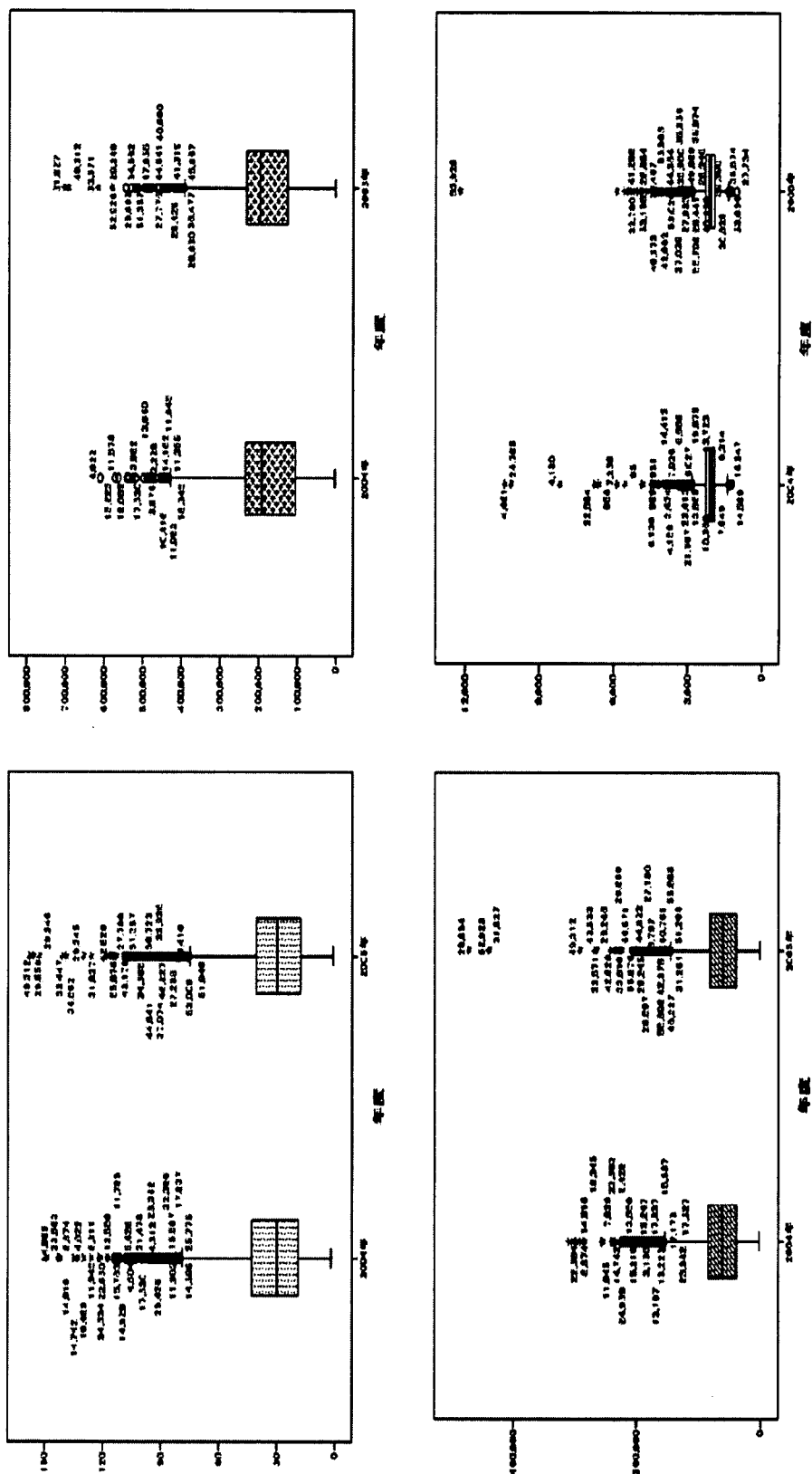

図B群(年齢)

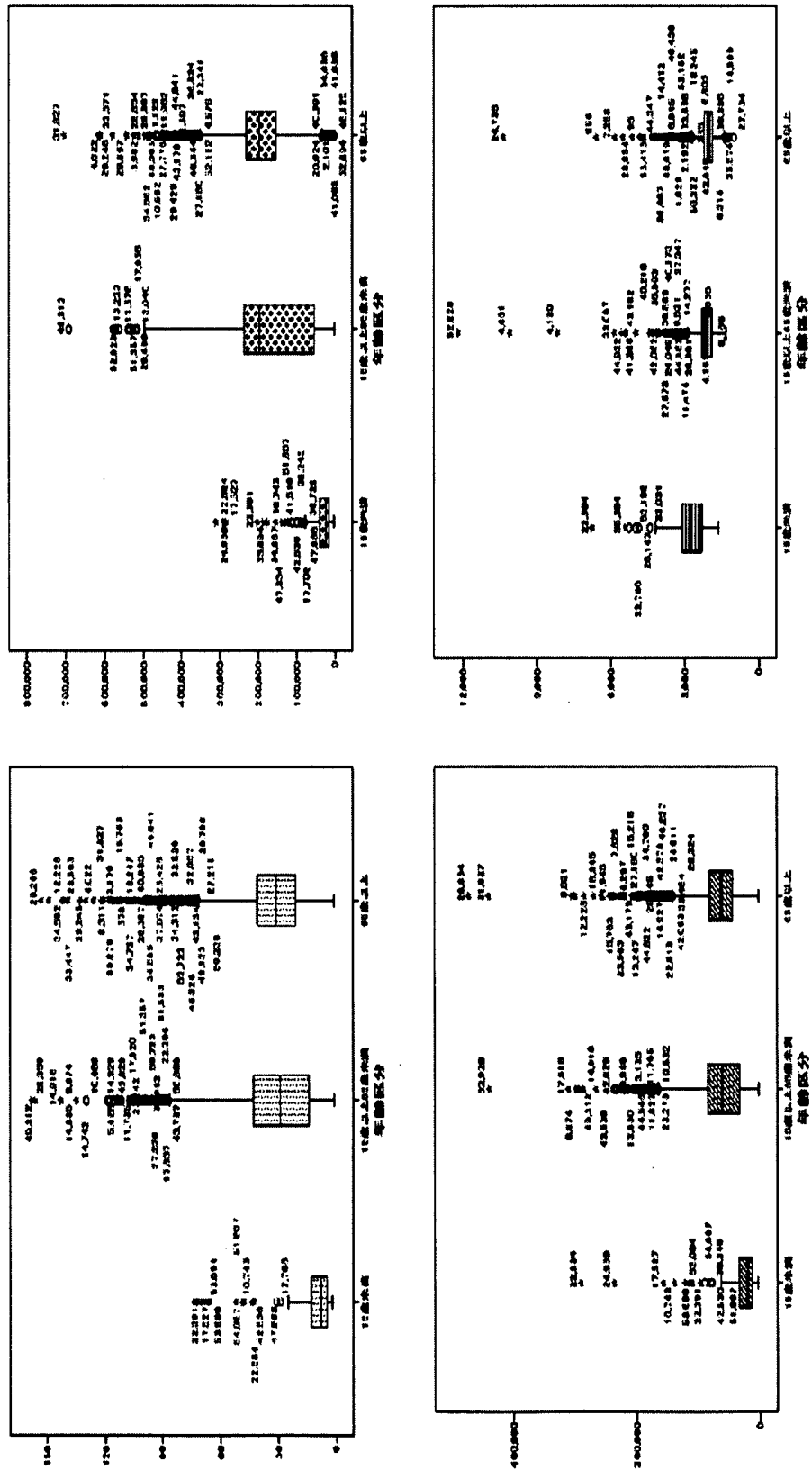

図B群(性別)

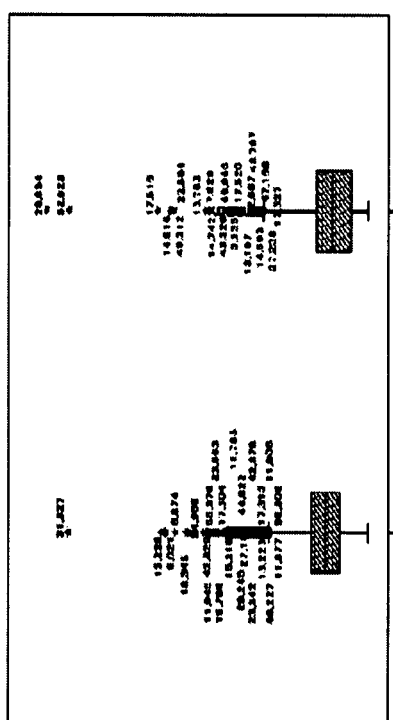
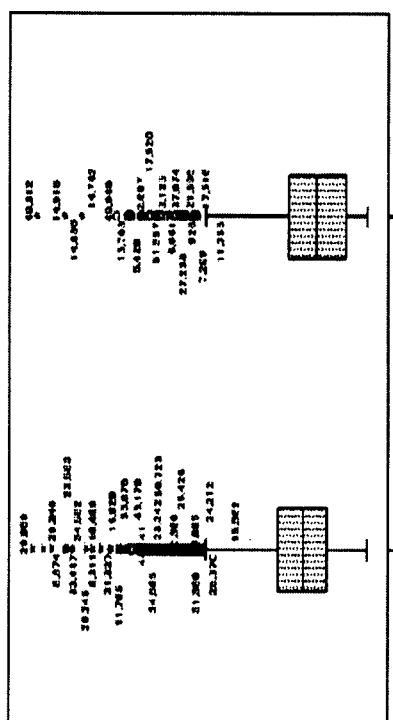
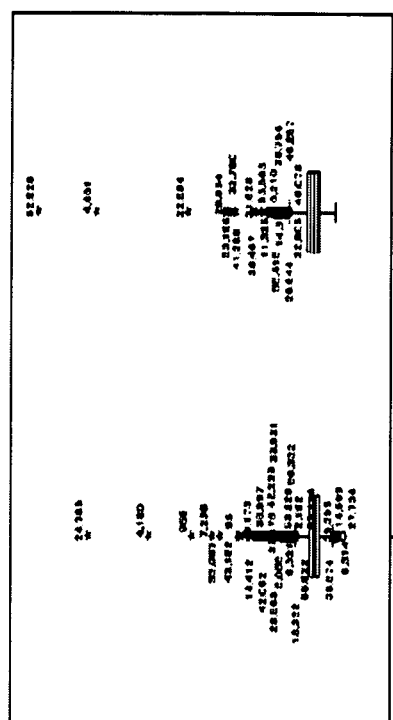
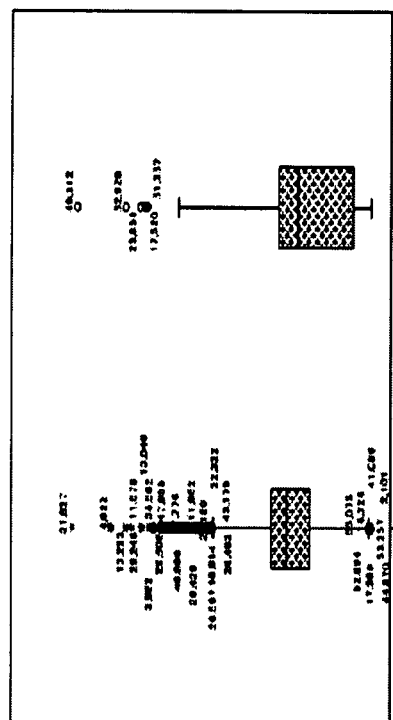

図B群(施設地域)

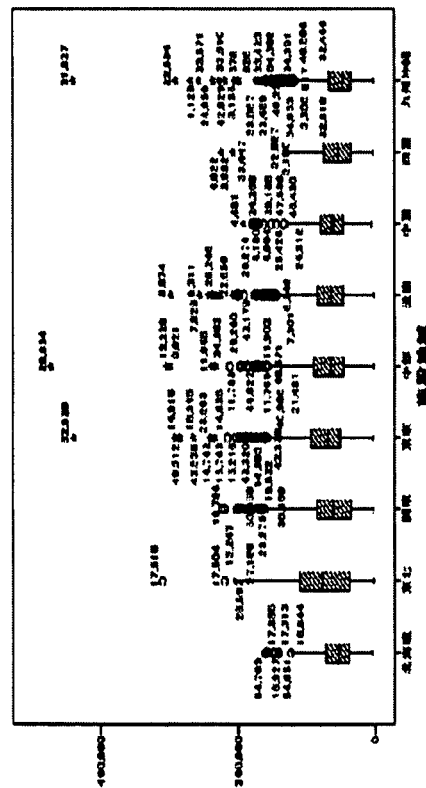
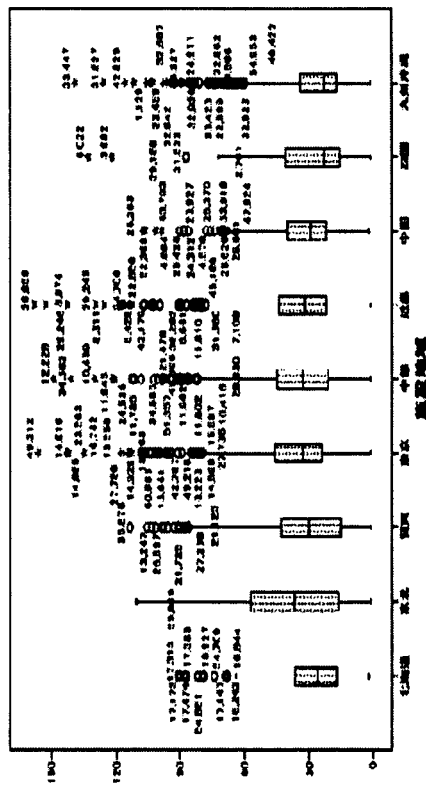
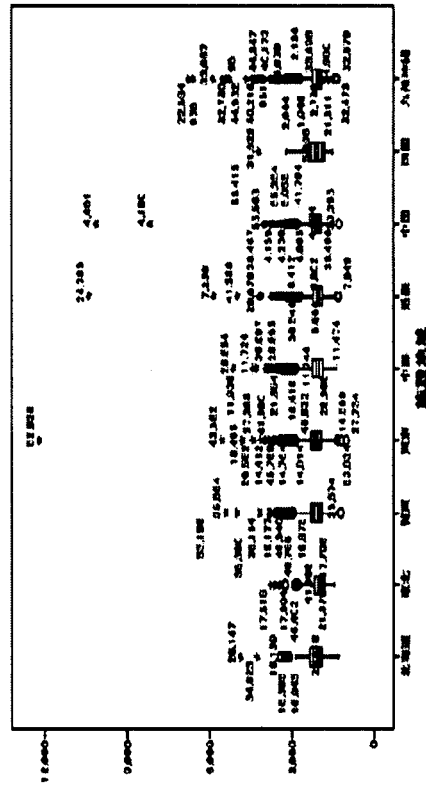
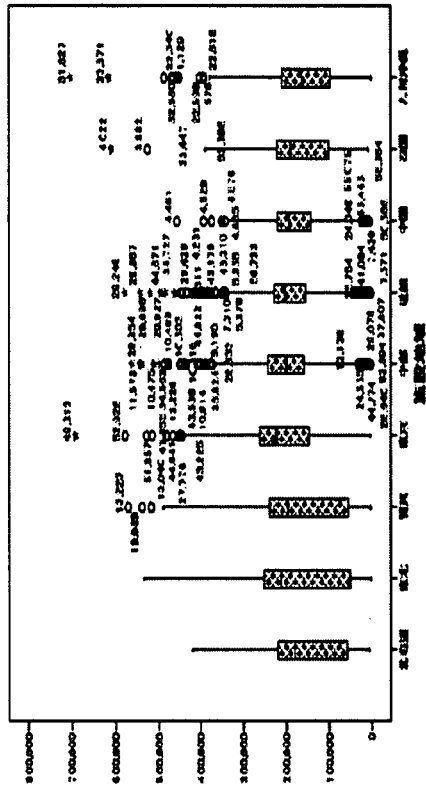

図B群(DPC病院)

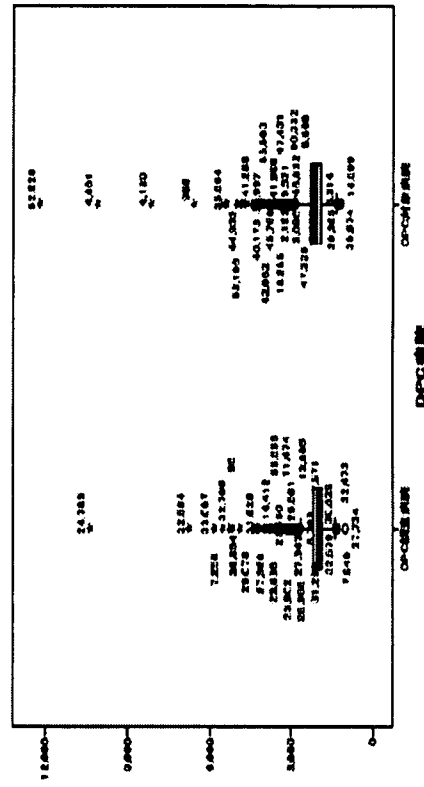
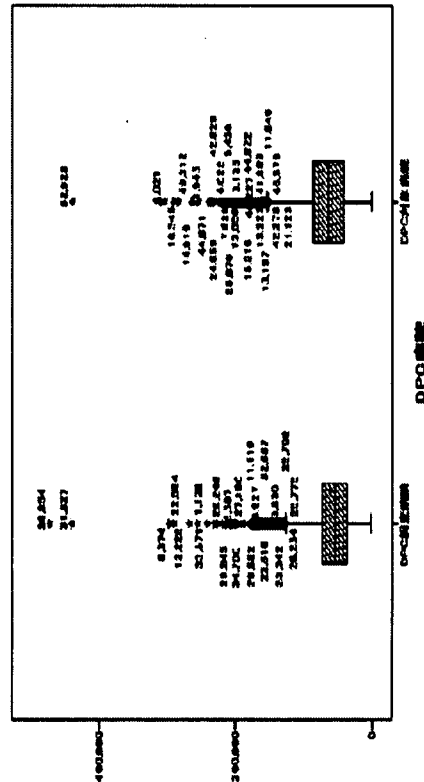
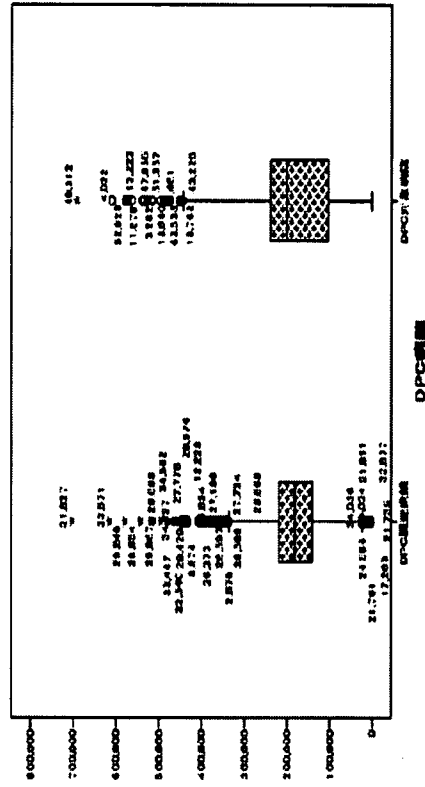
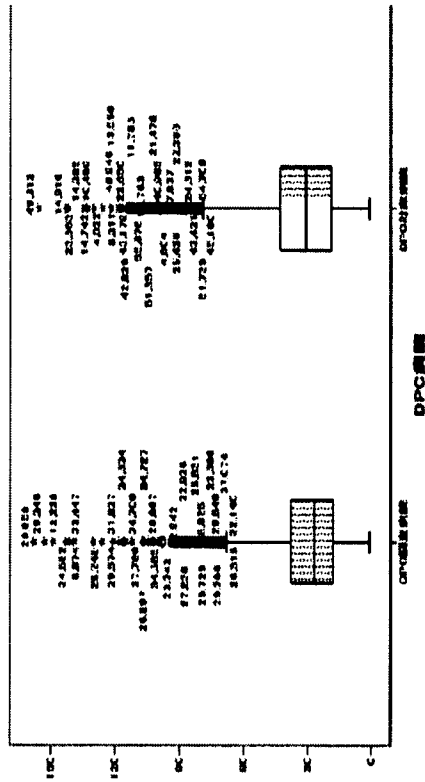

図B群(施設機能)

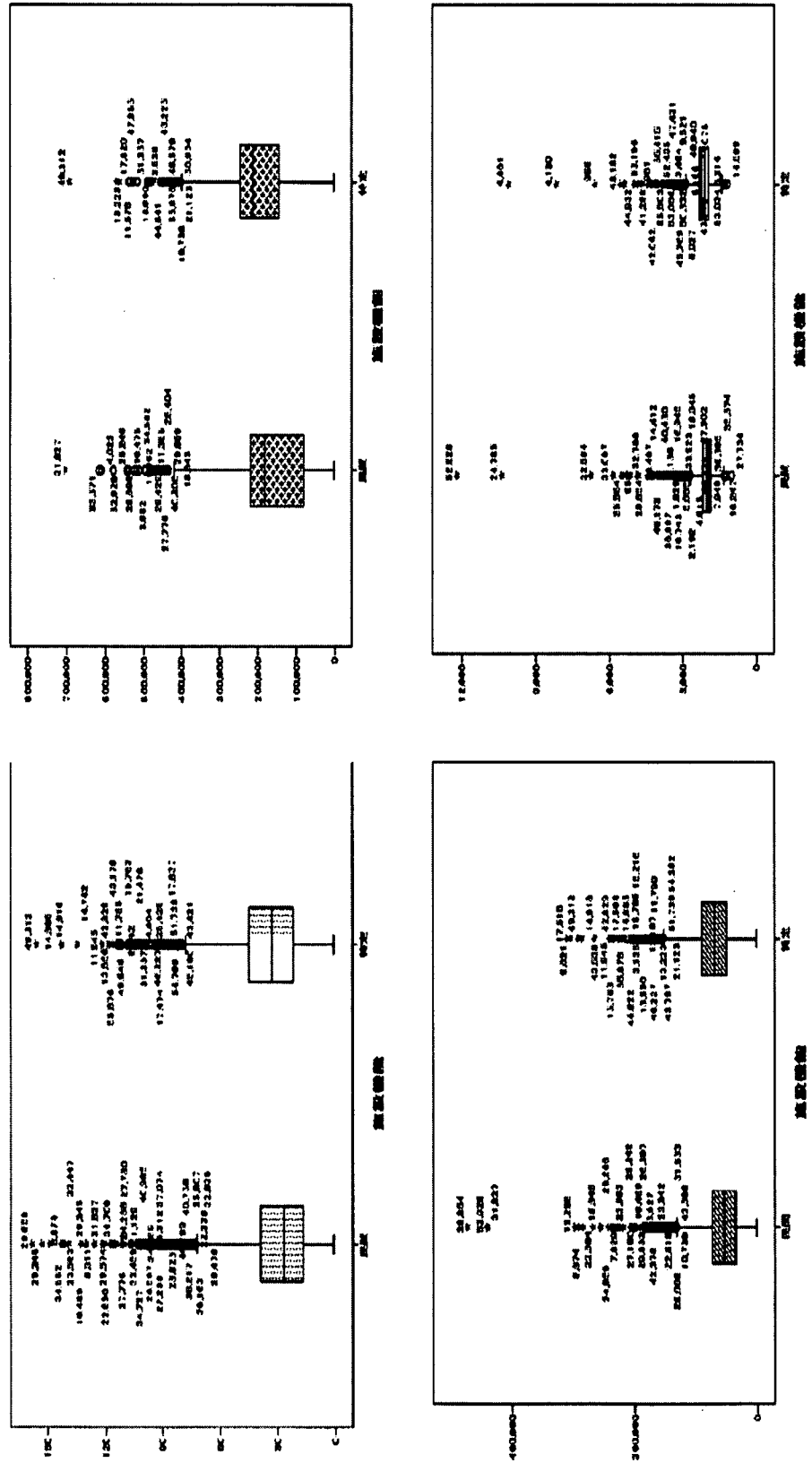

図B群(救急車搬送)

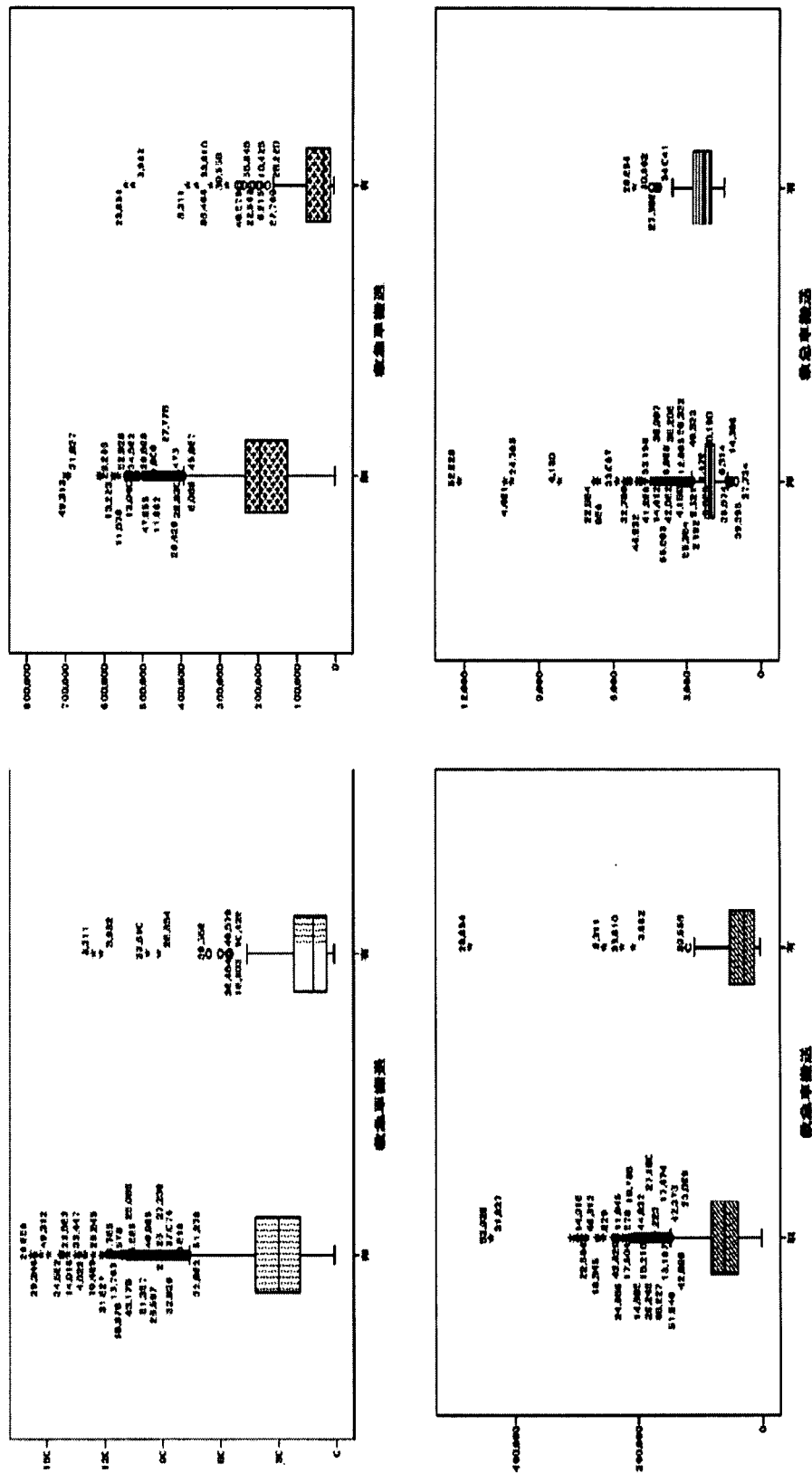

図B群(ADL)

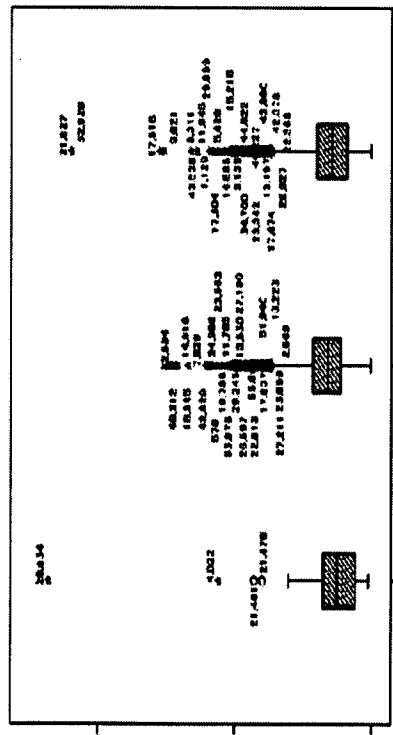
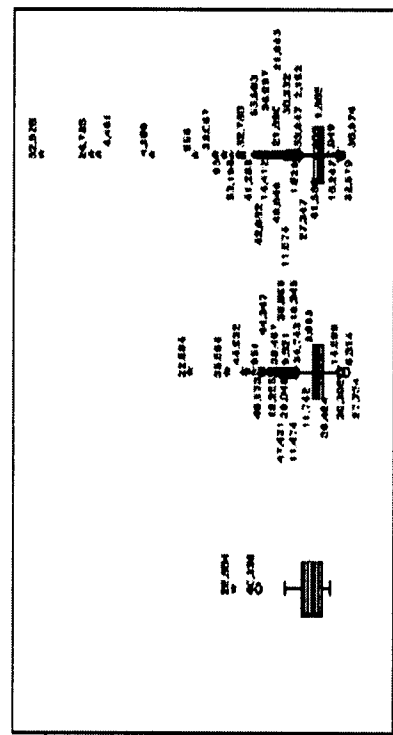
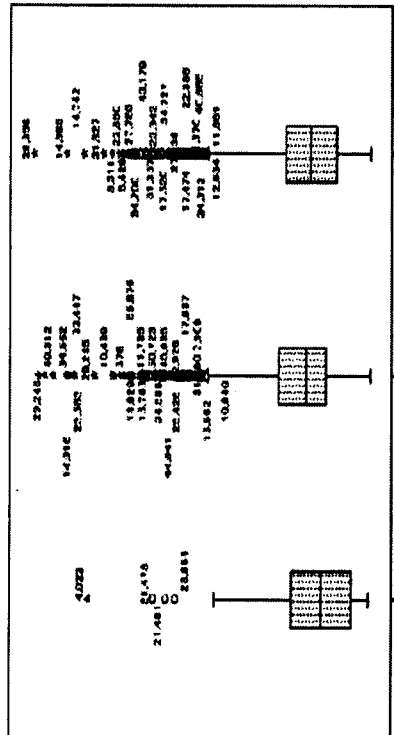
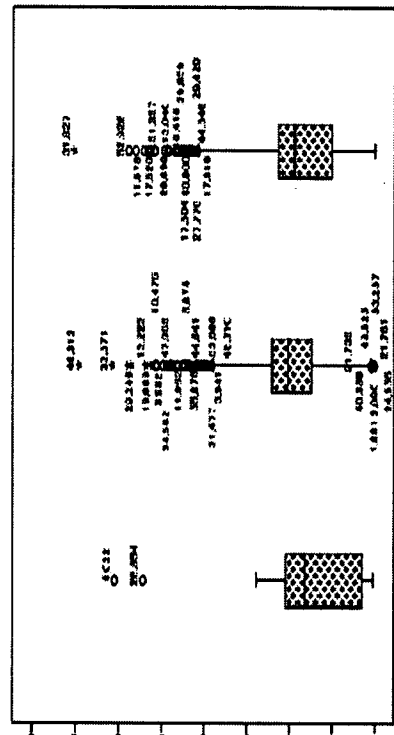

図B群(手術)

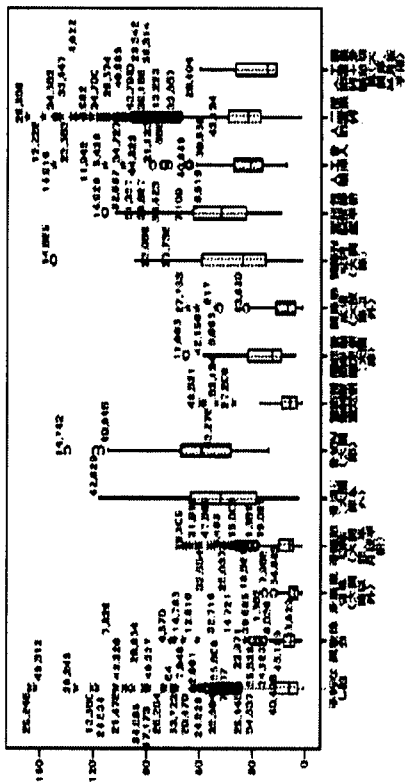

手術(手術)

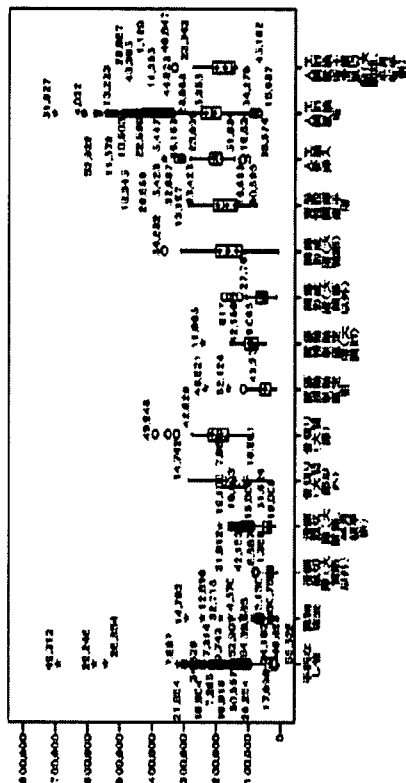

手術(手術)

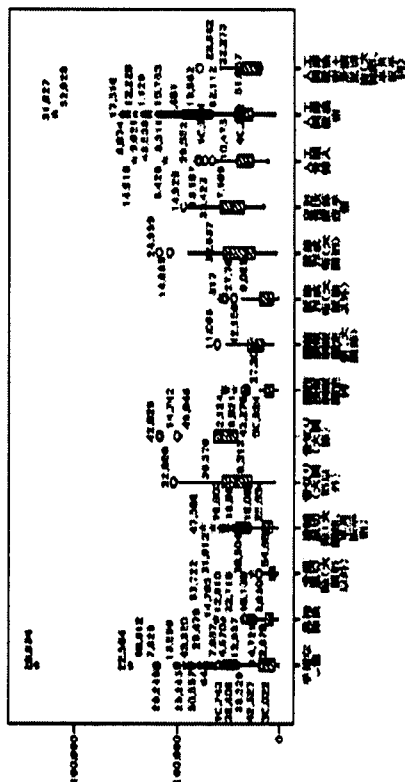

手術(手術)

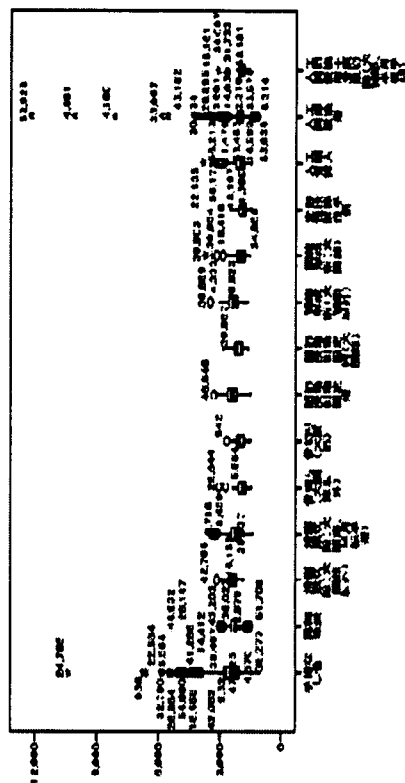

手術(手術)

図B群(手術)

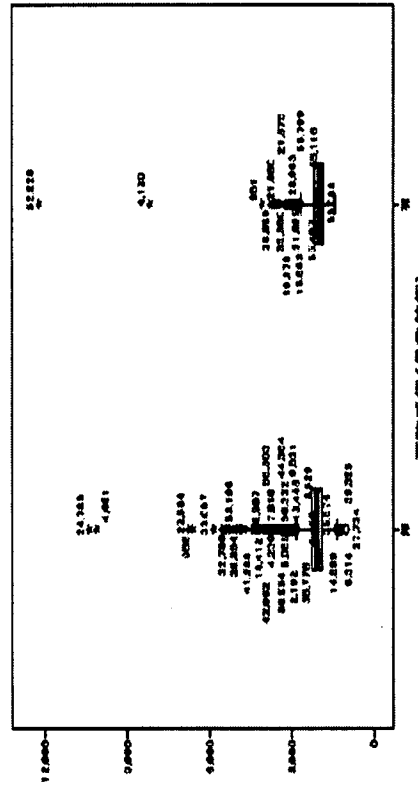
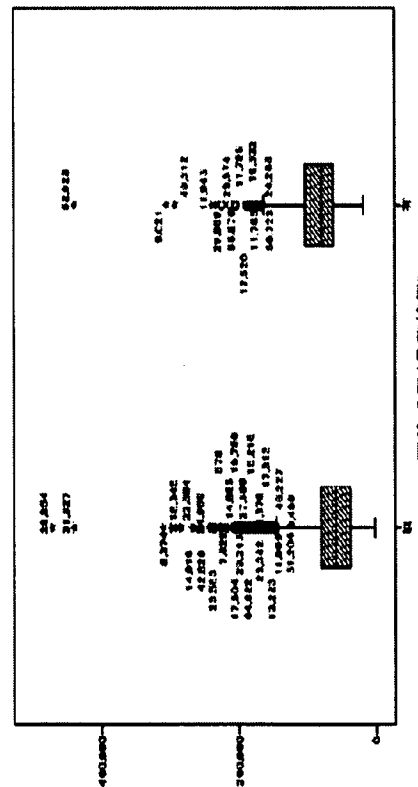
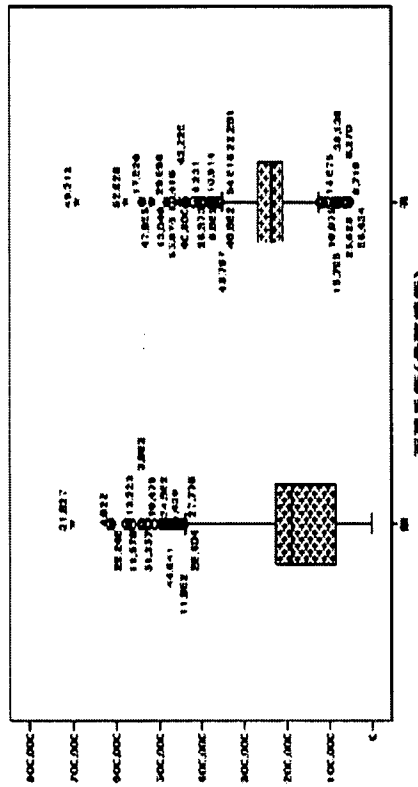
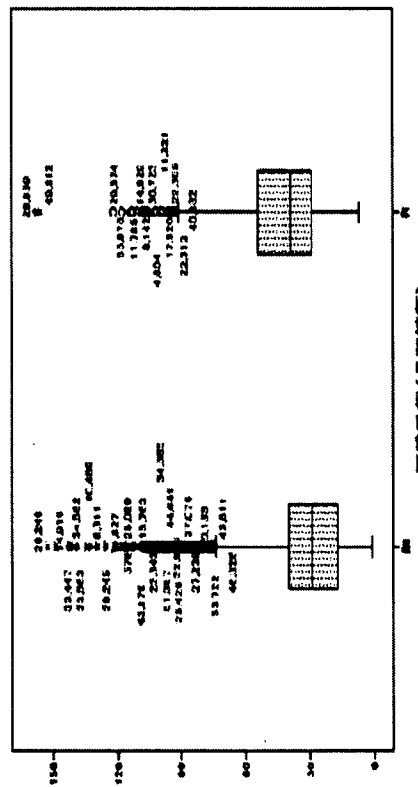

図B群(中心静脈)

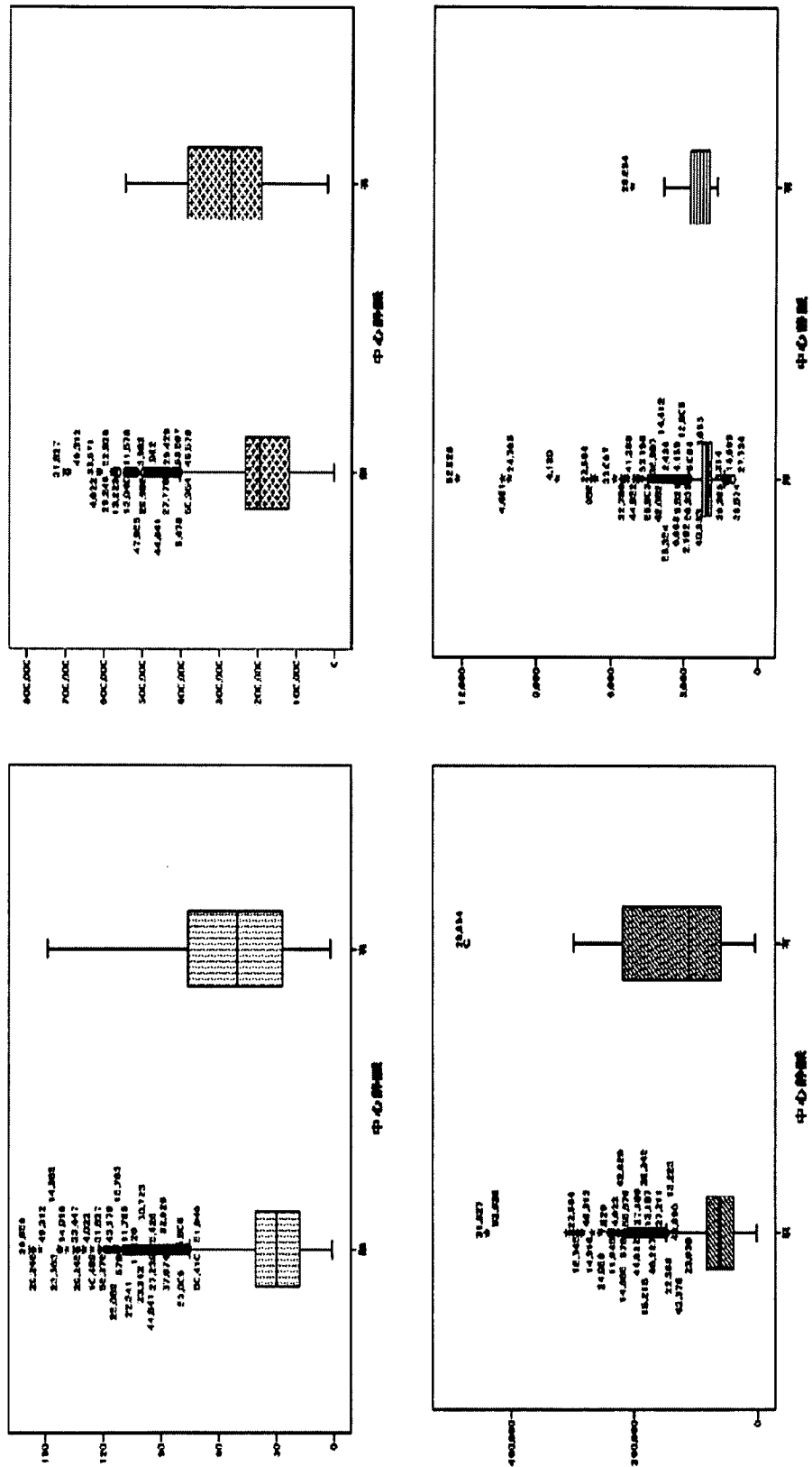

図B群(血液透析浄化)

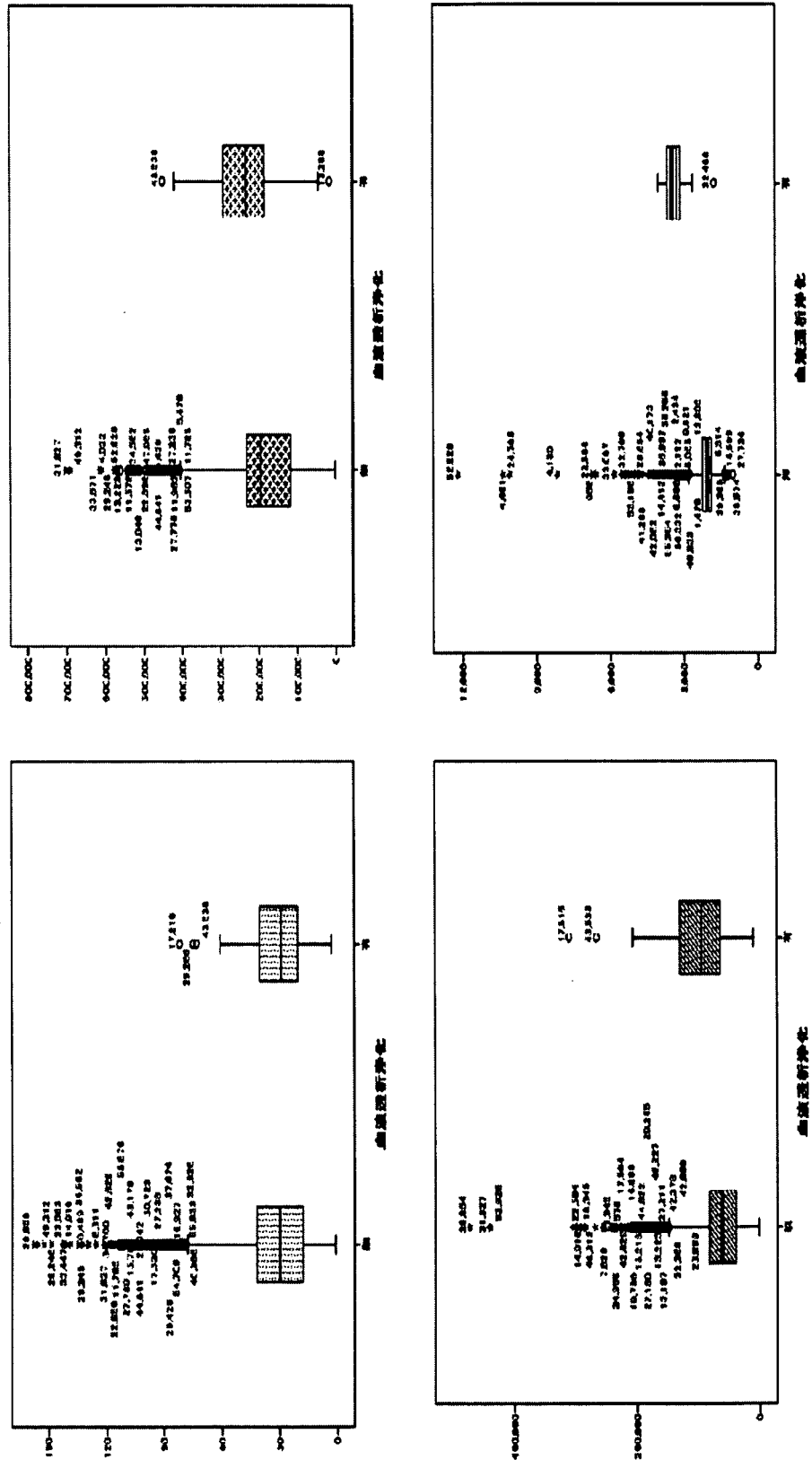

図B群(リハビリ)

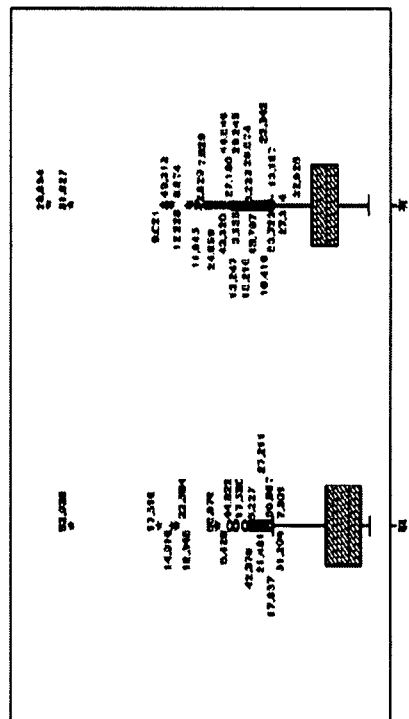
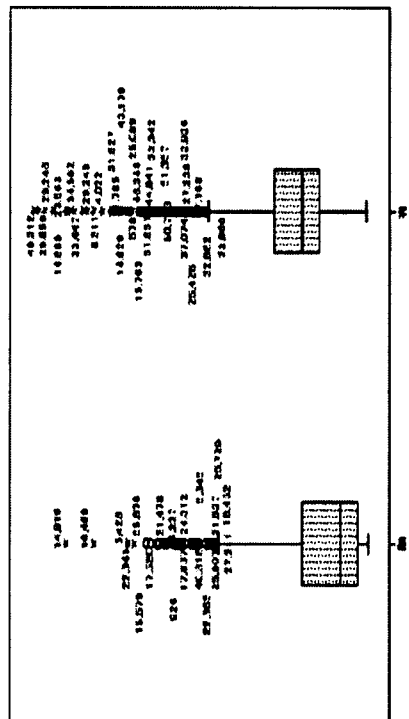
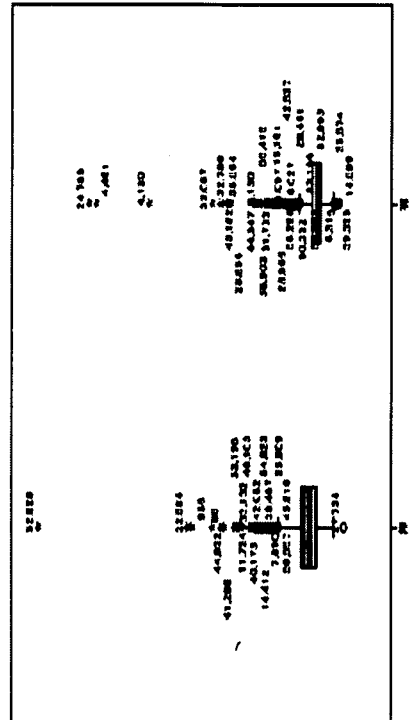
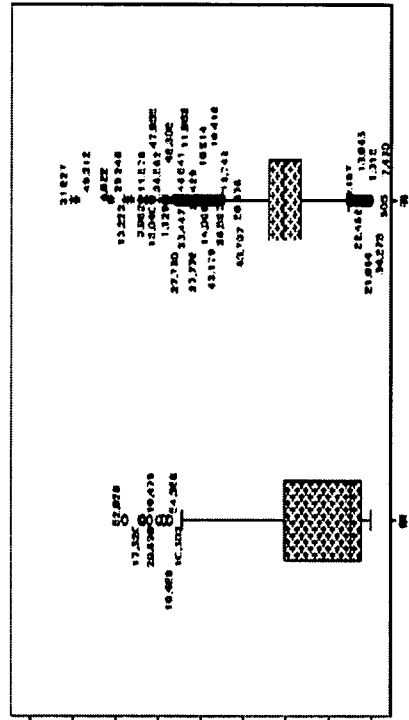

図B群 (Charlson Comorbidity Index)

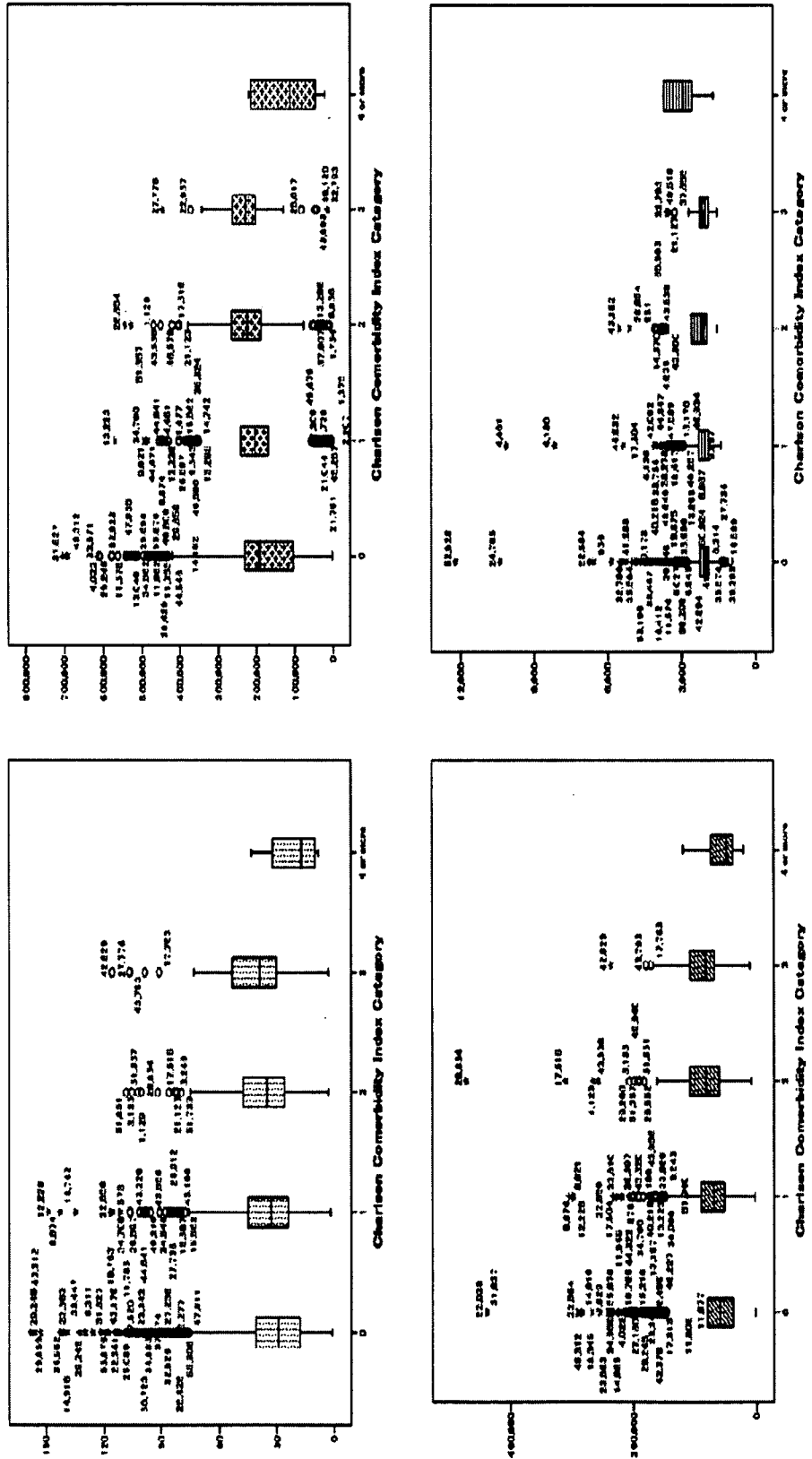

図B群(手術関連連続発症)

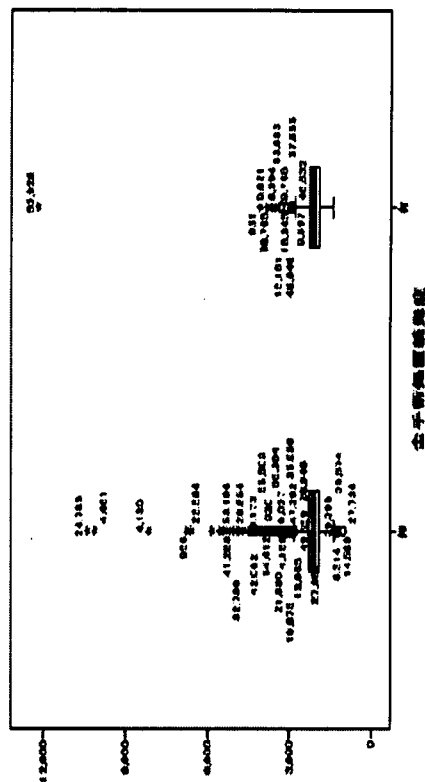
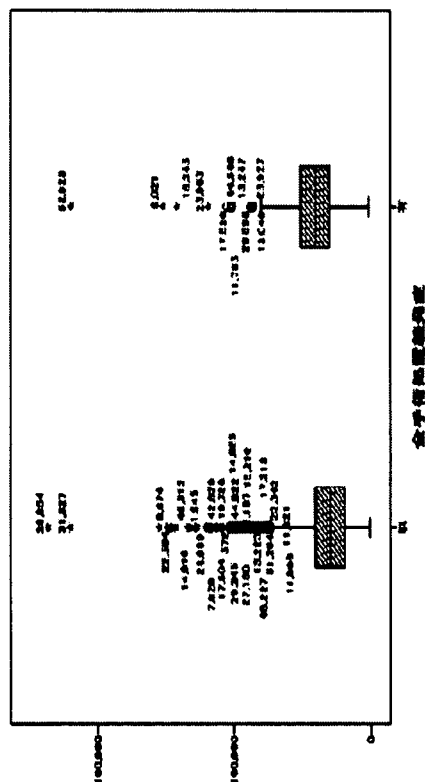
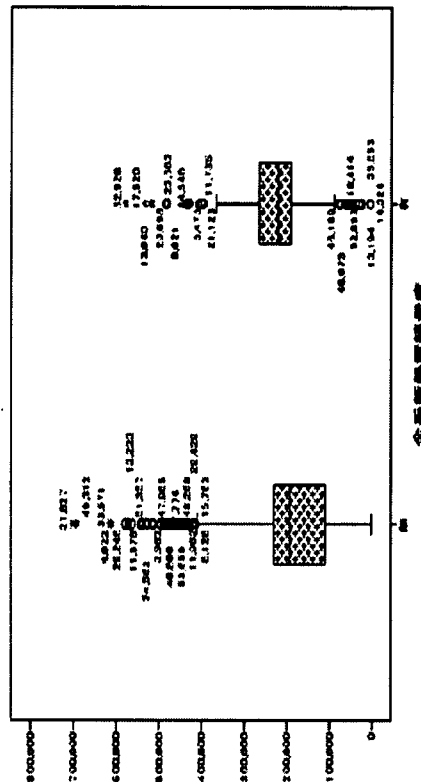
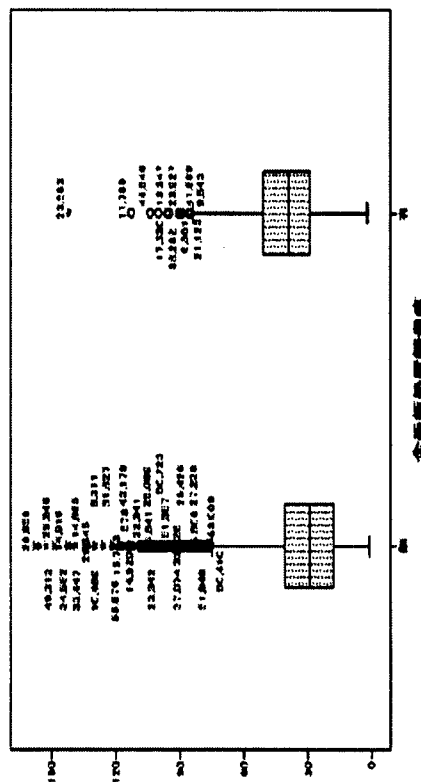

図B群(静脈血栓肺梗塞)

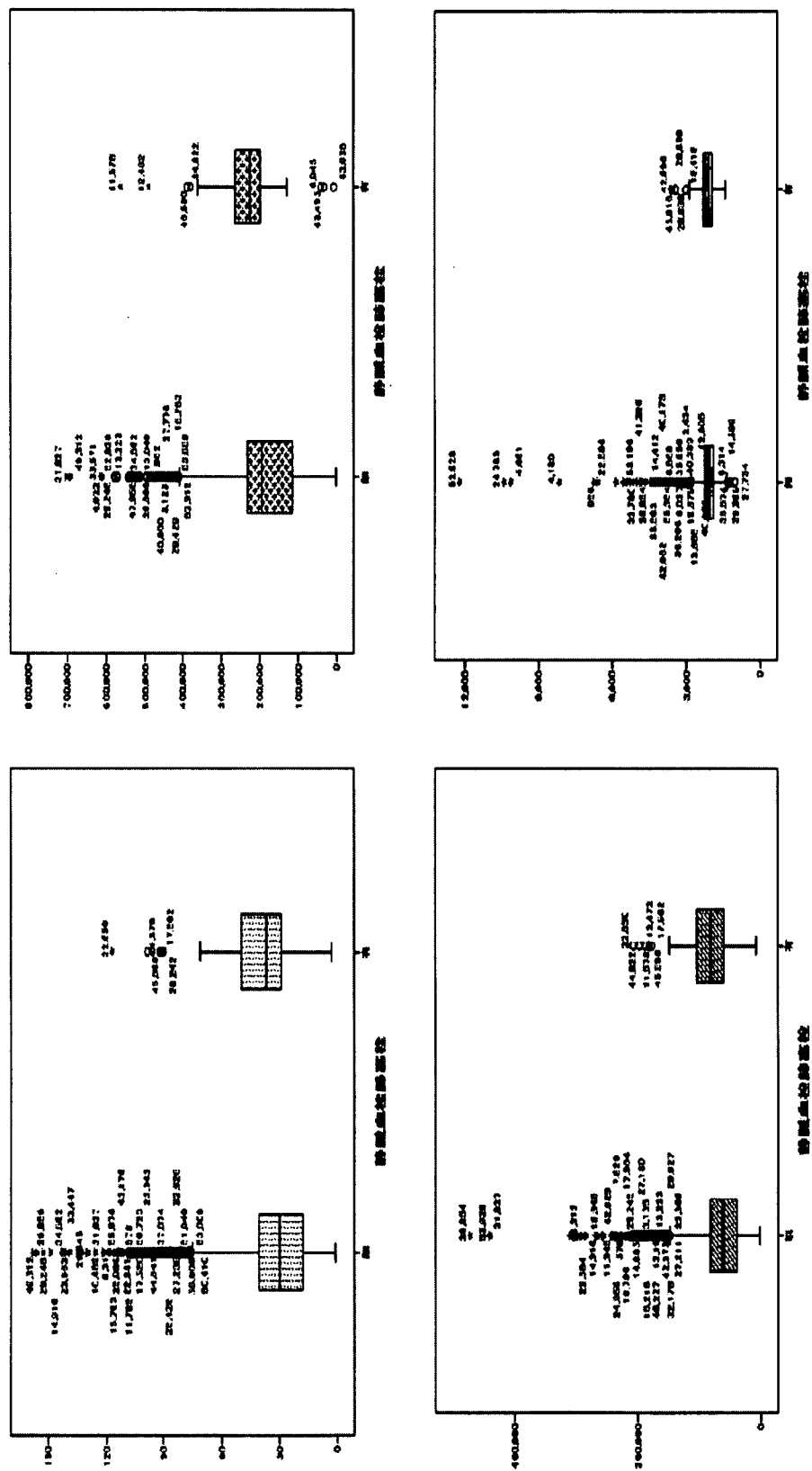

图C群(在院日数分析)

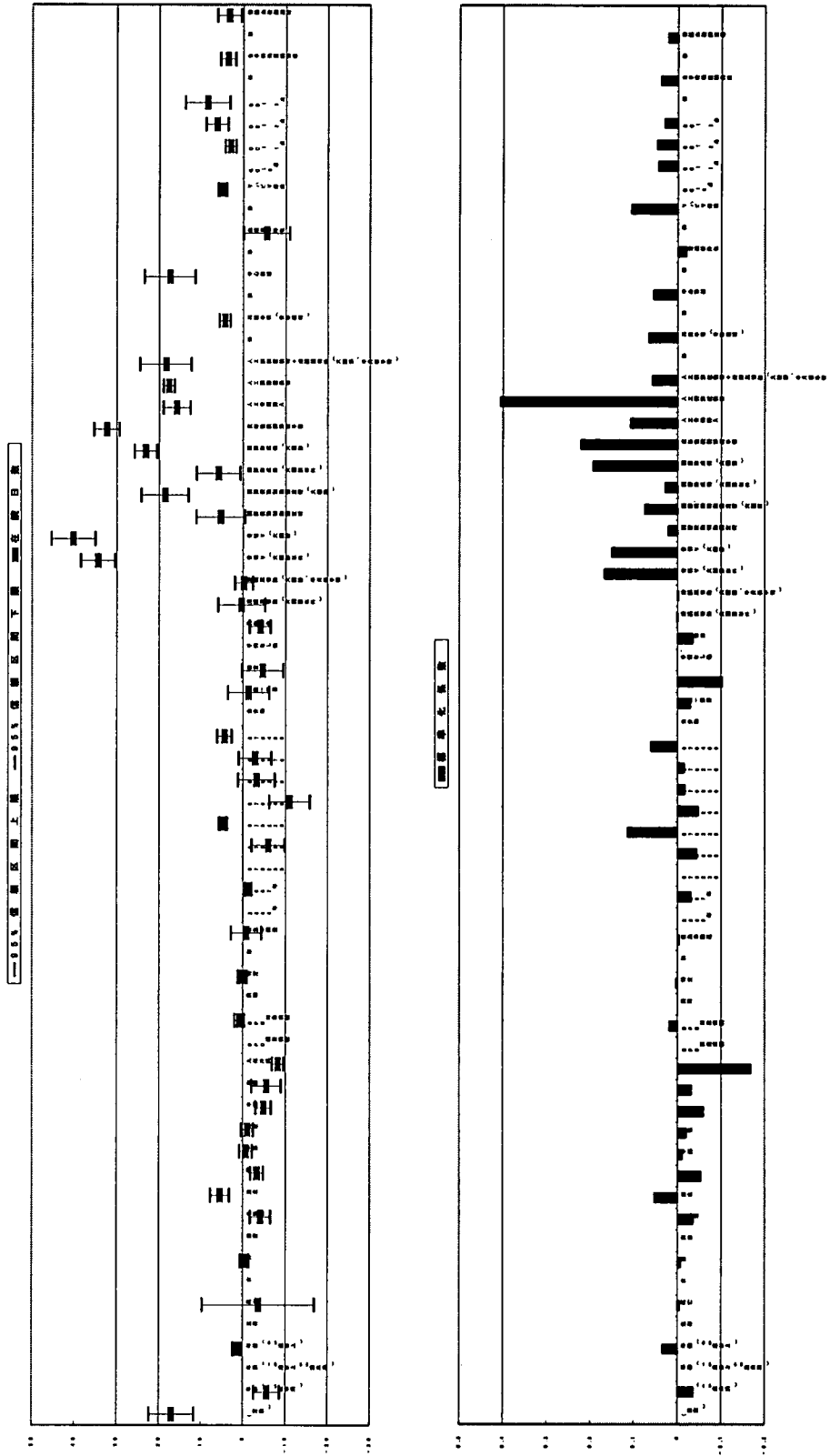

図C群(総点数分析)

