

# 図A群

在院日数、総点数、包括範囲総点数、包括範囲一日点数

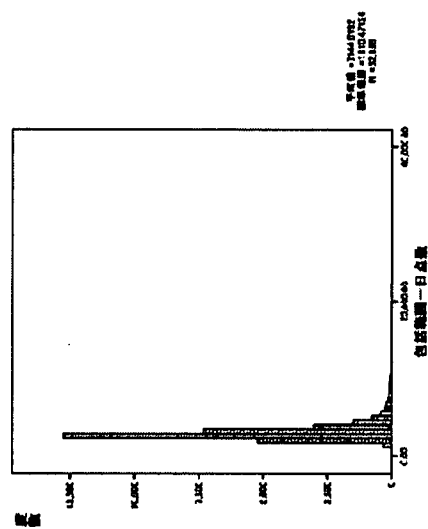

# 図B群(基本DPC)

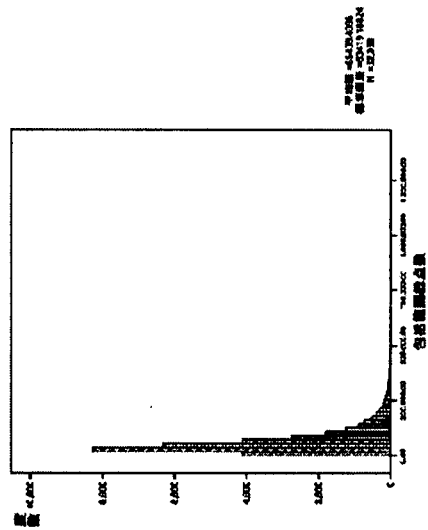
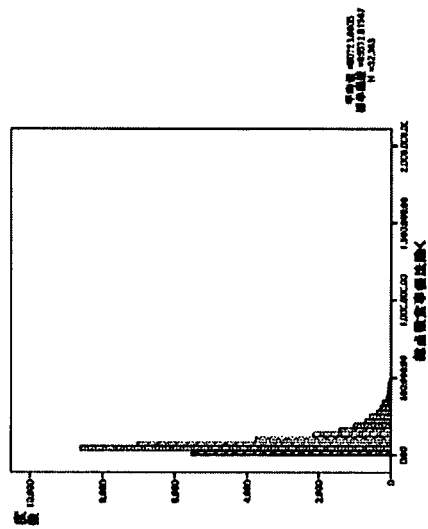
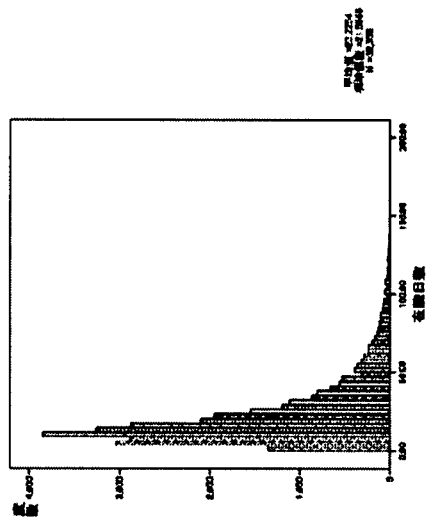
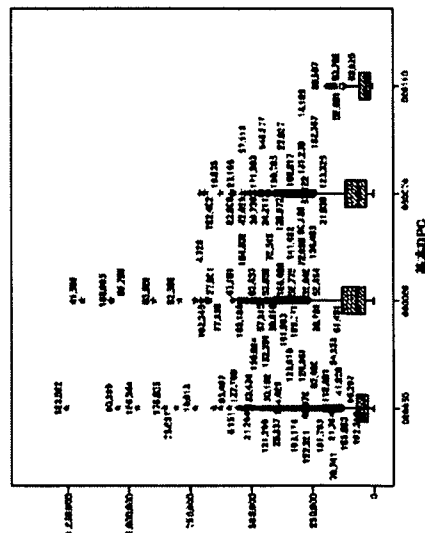
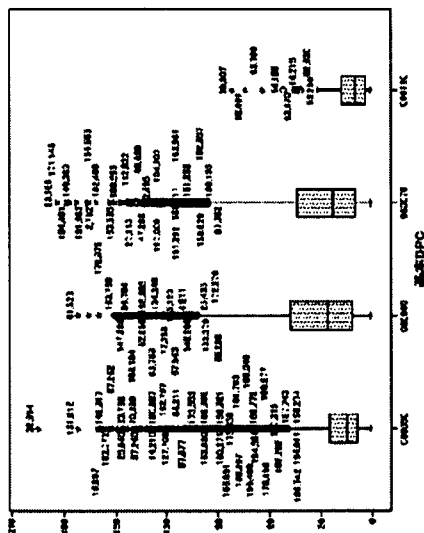
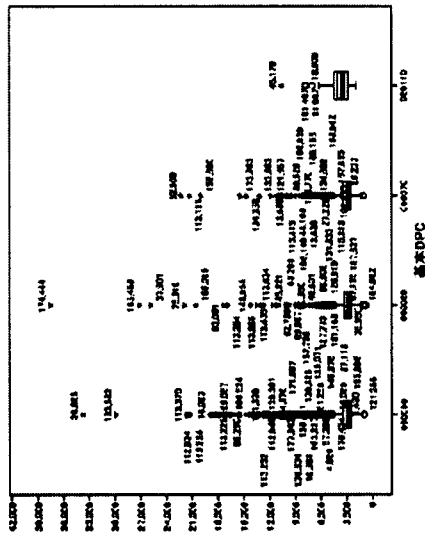
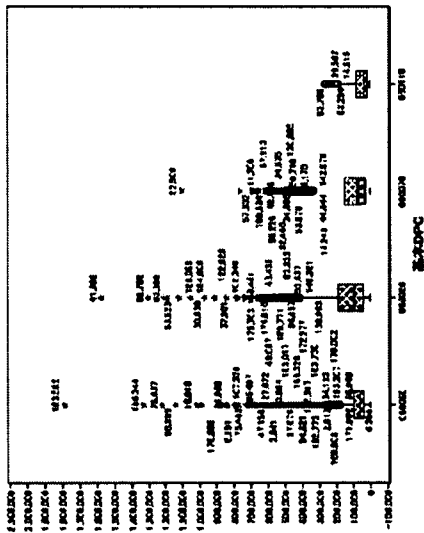

# 図B群(年度)

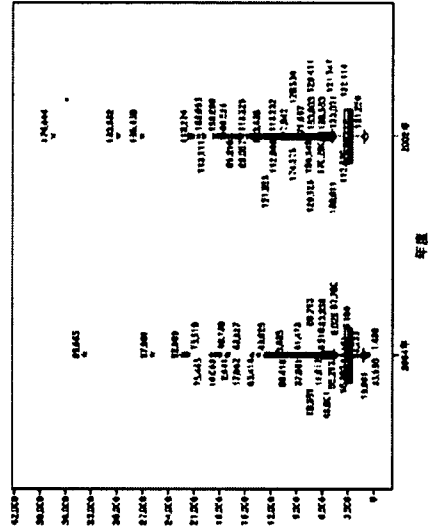
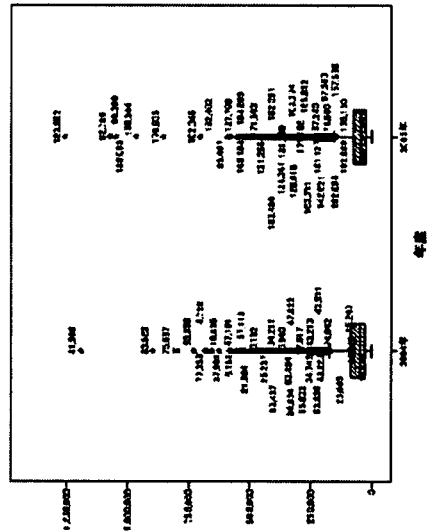
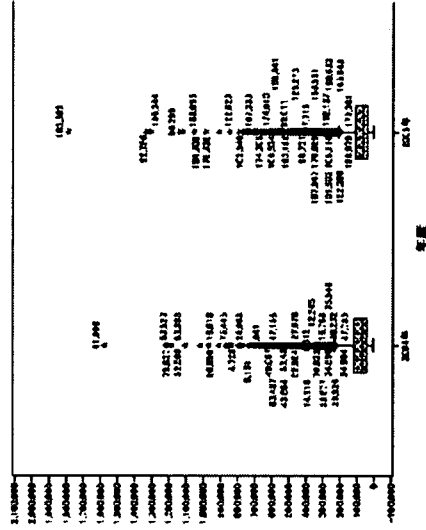
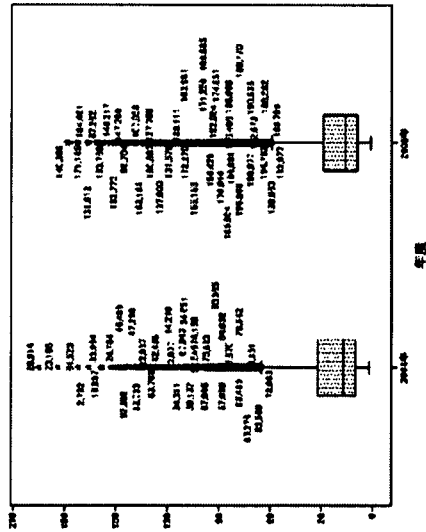

# 図B群(退院時転帰)

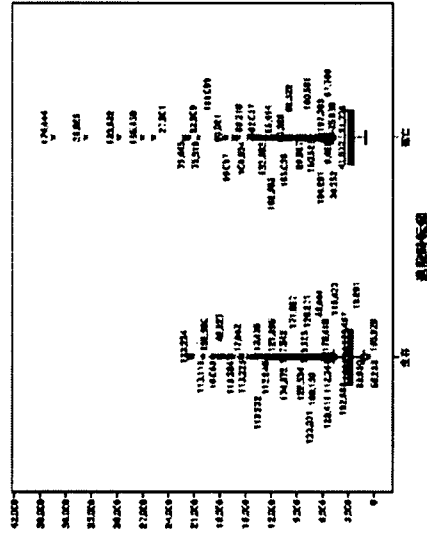
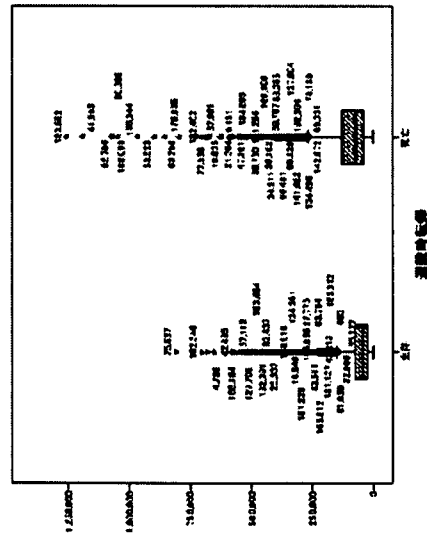
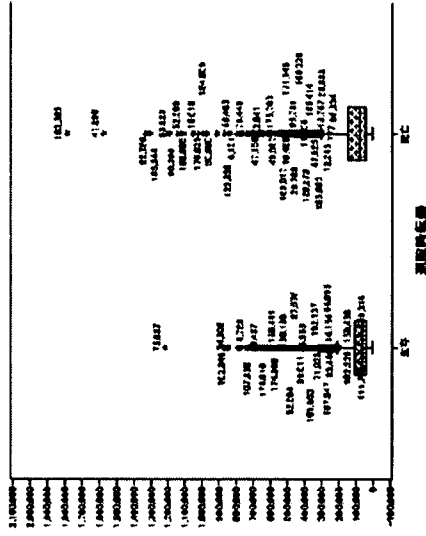
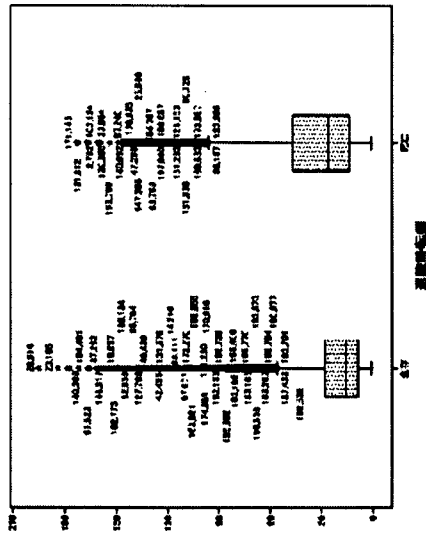

# 図B群(年齢)

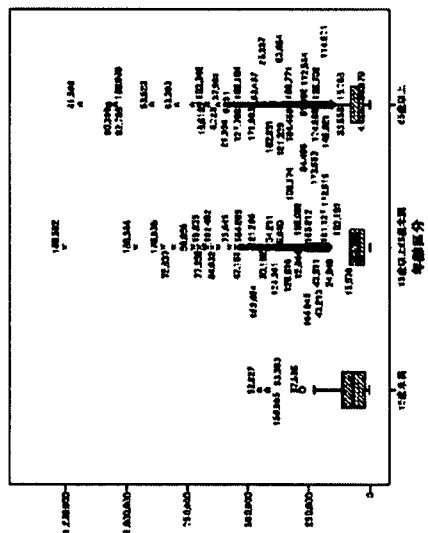
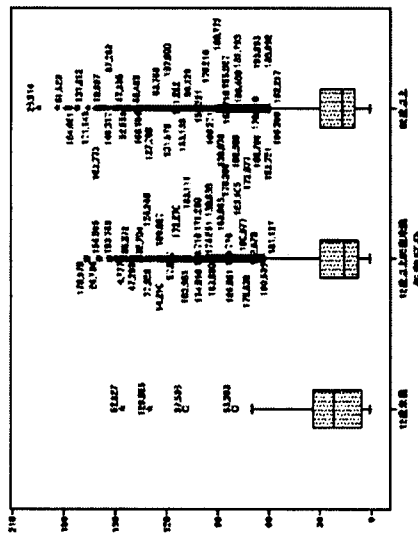
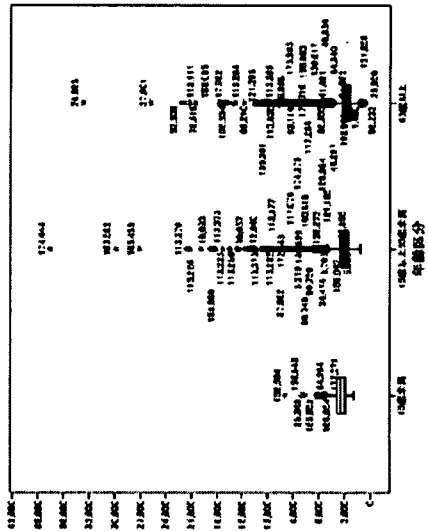
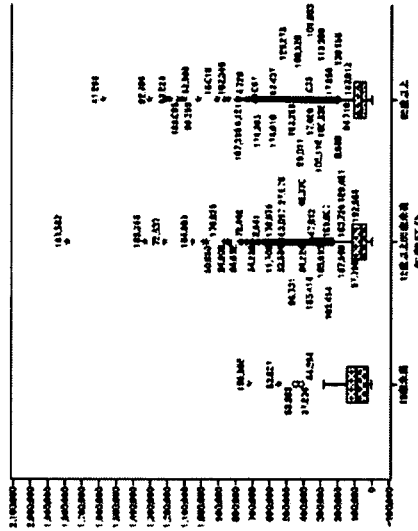

# 図B群(性別)

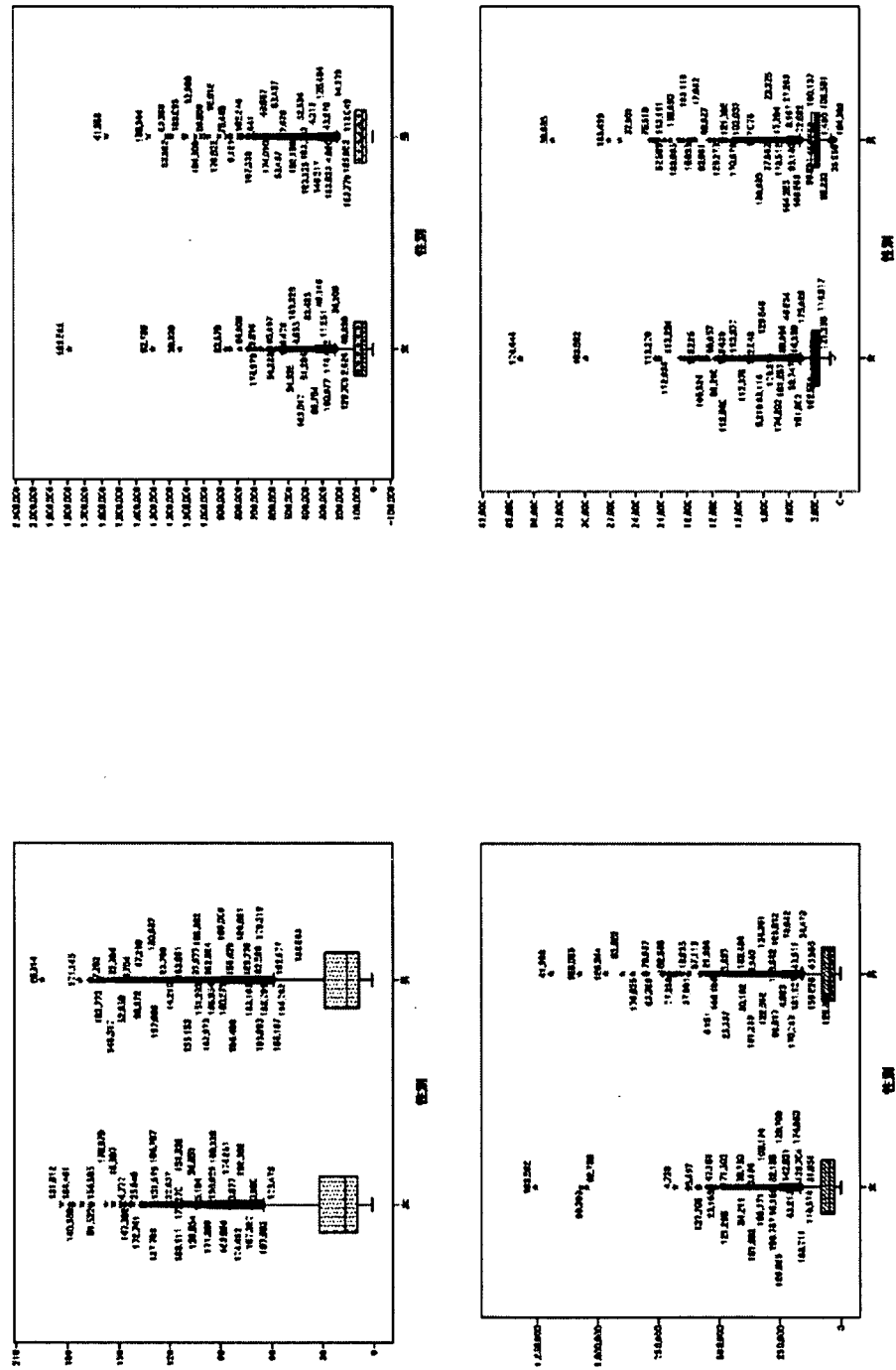

# 図B群(施設地域)

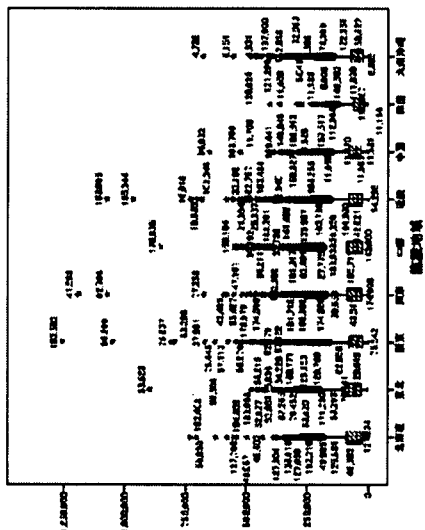
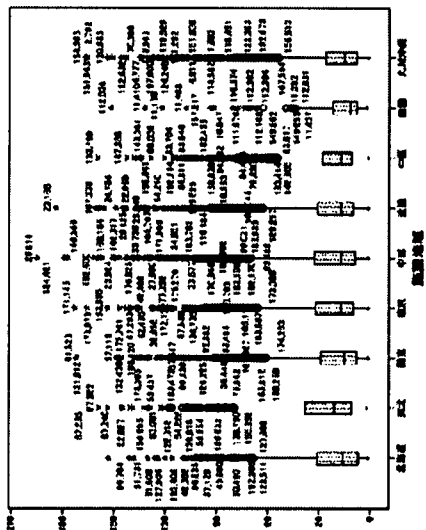
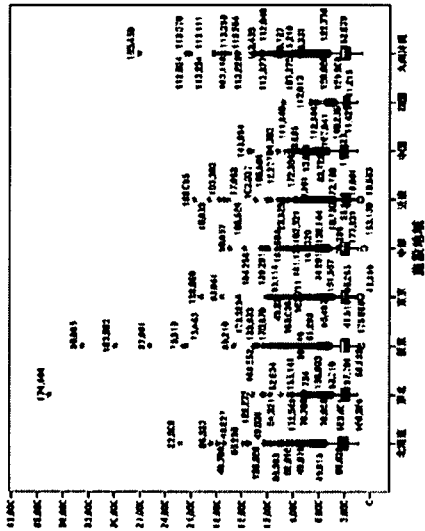
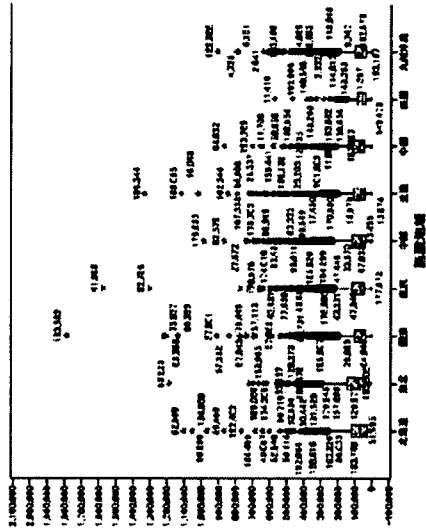

# 図B群(DPC病院)

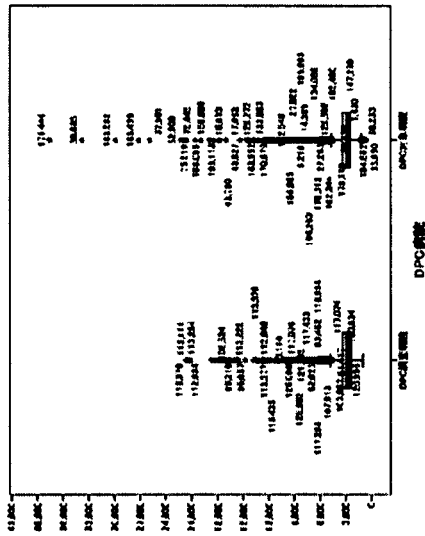
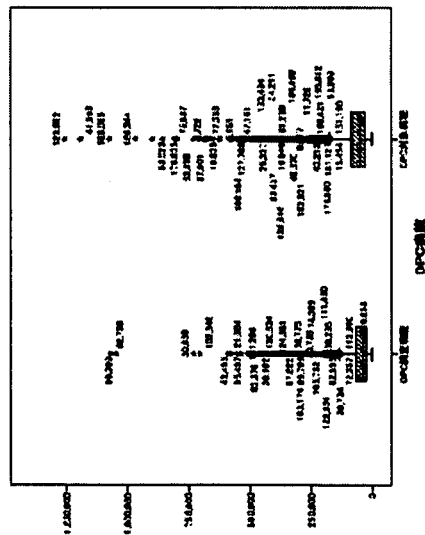
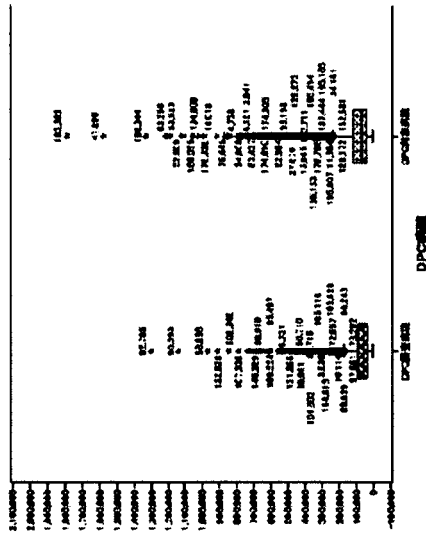
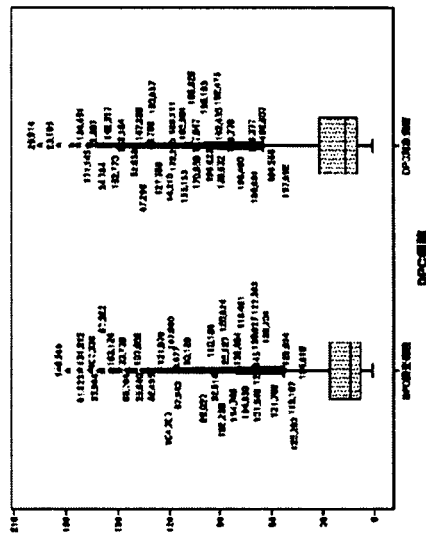



# 図B群(施設機能)

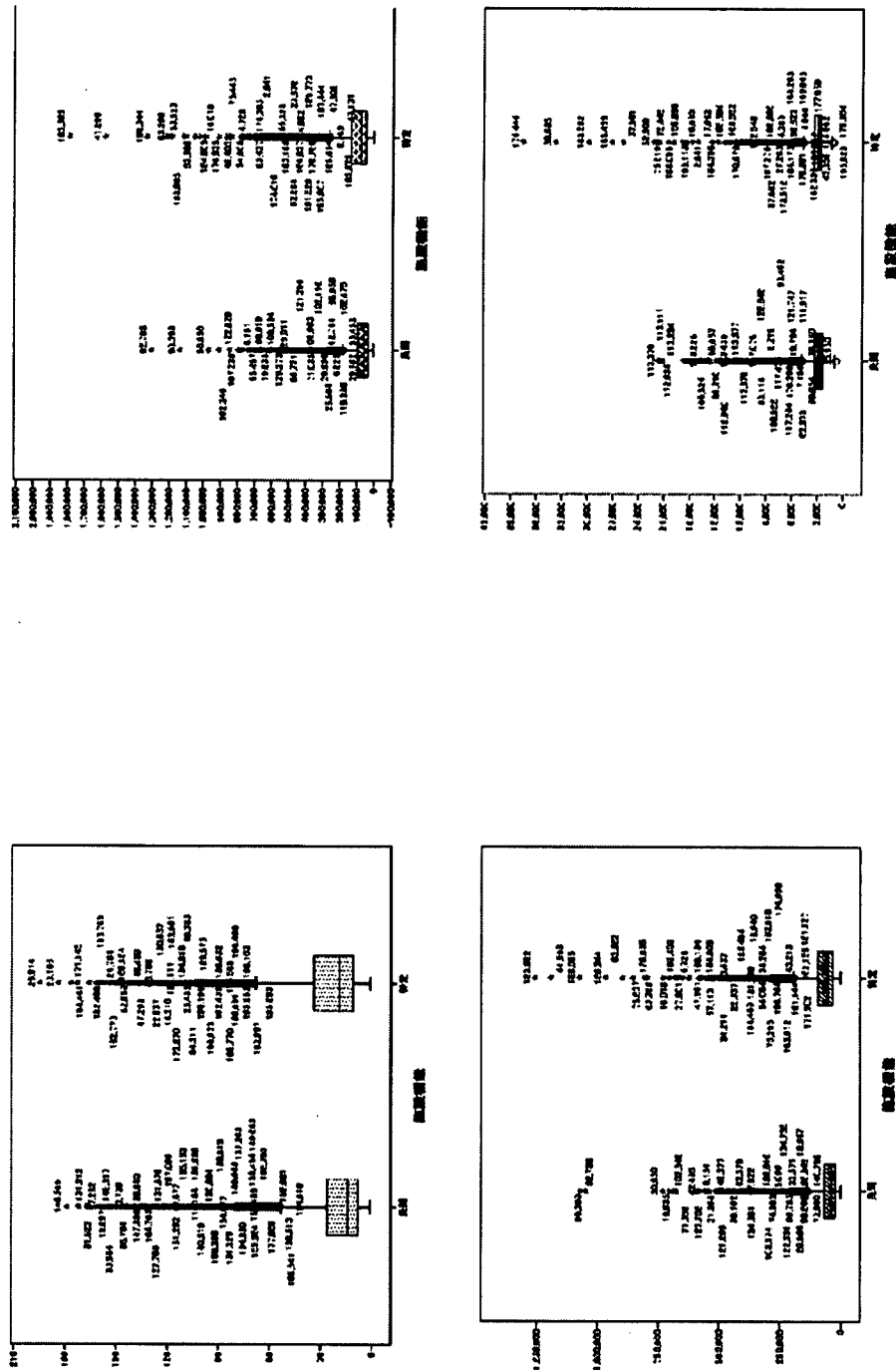

# 図B群(救急車搬送)

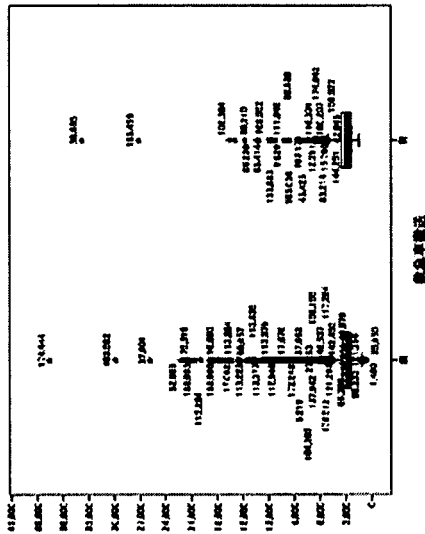
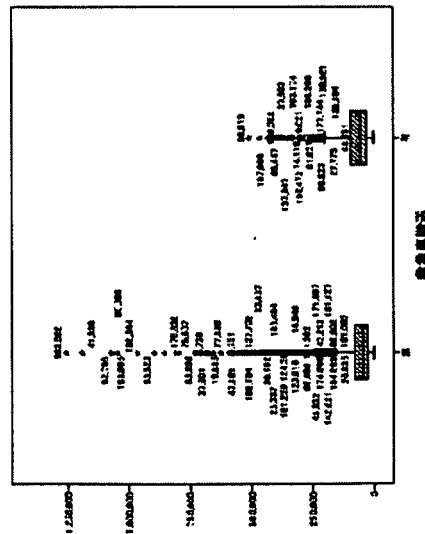
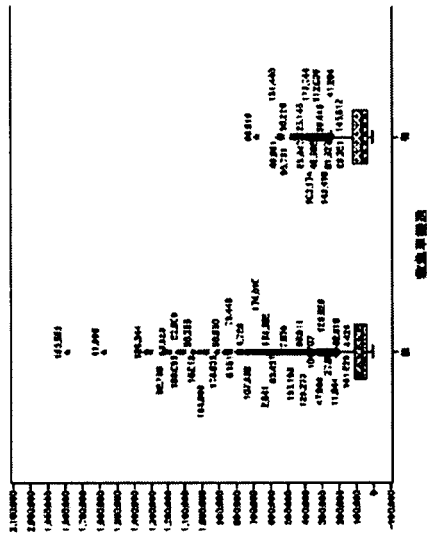
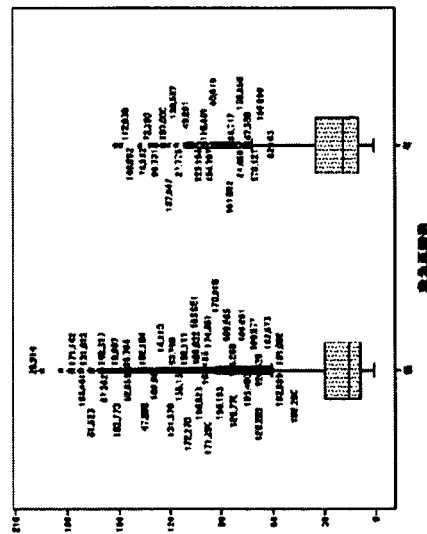

# 図B群(ステージ分類)

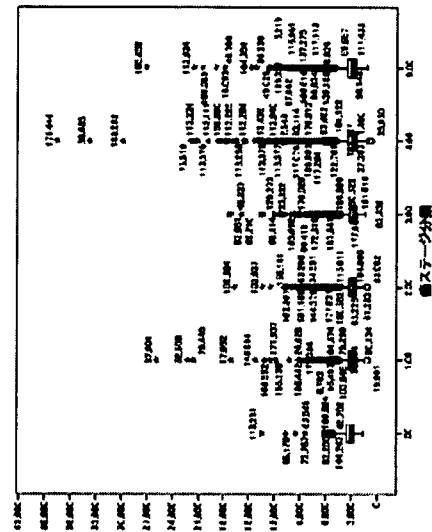
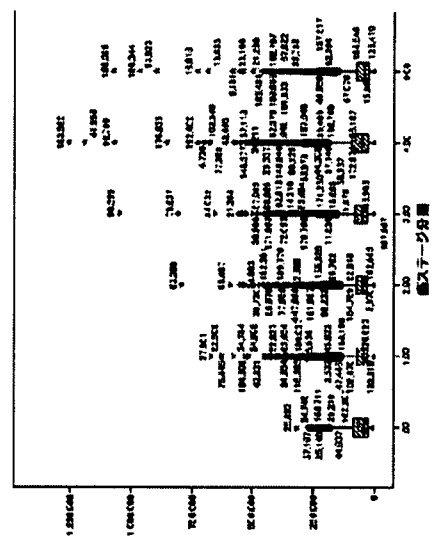
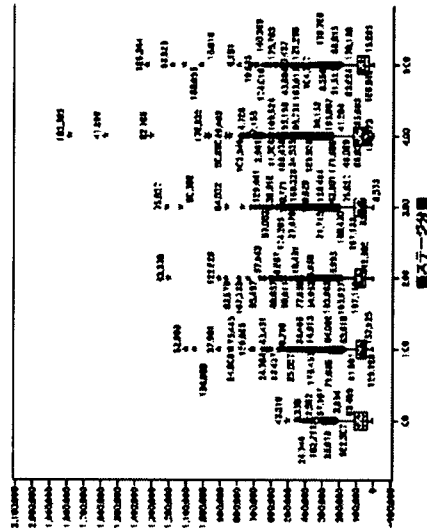
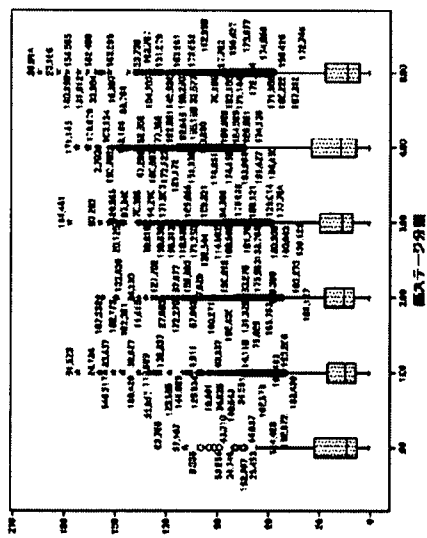

# 図B群(手術)

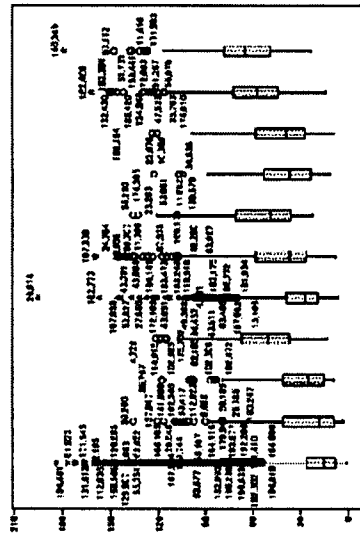

手術時間 (分) 手術種別

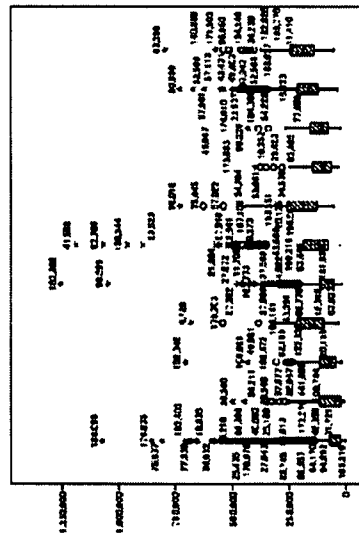

手術時間 (分) 手術種別

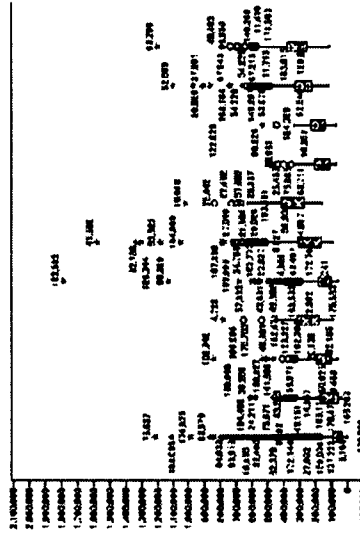

手術時間 (分) 手術種別

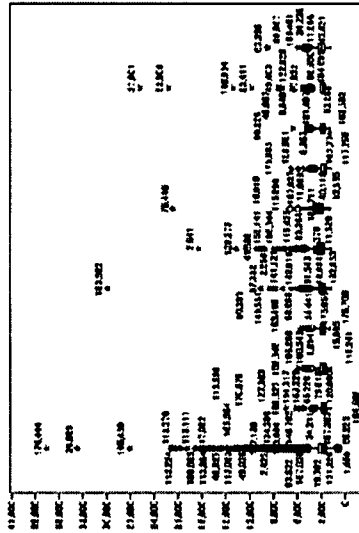

手術時間 (分) 手術種別

# 図B群(食道静脈瘤硬化療法)

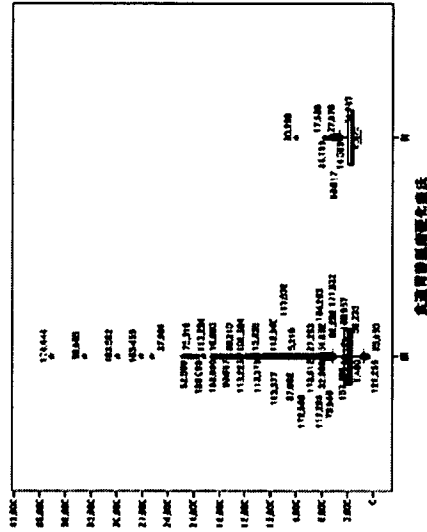
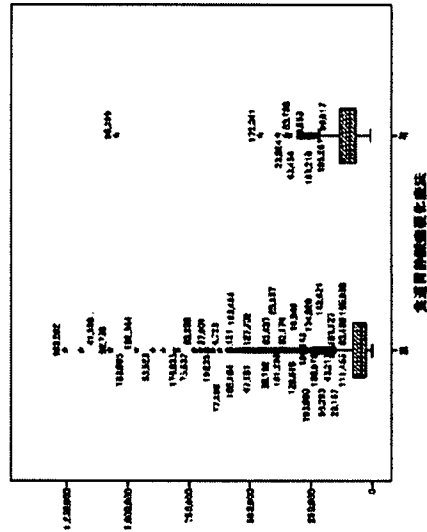
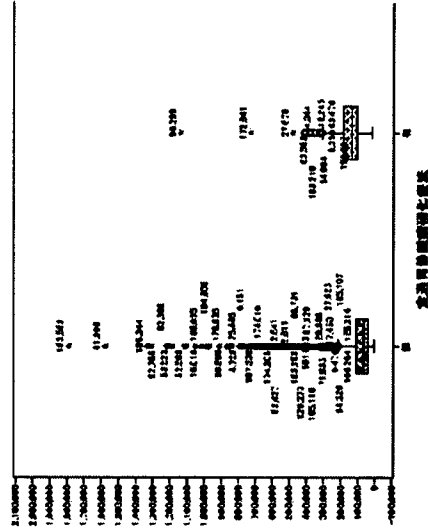
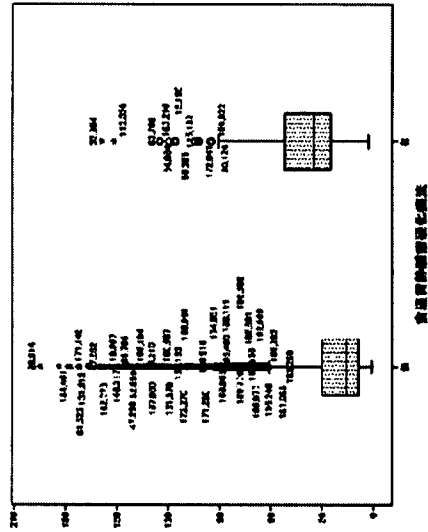

# 图B群(胆汁外瘦)

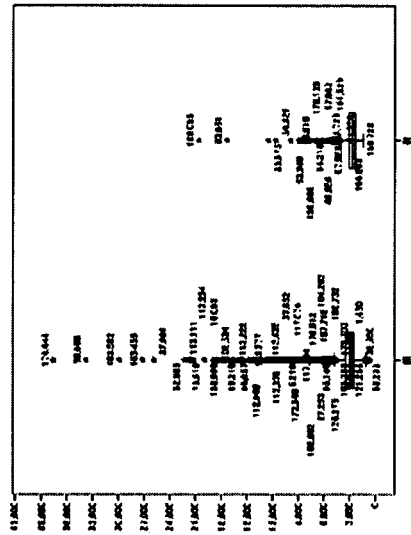
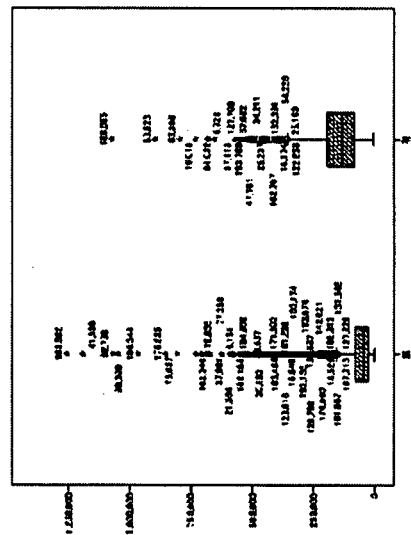
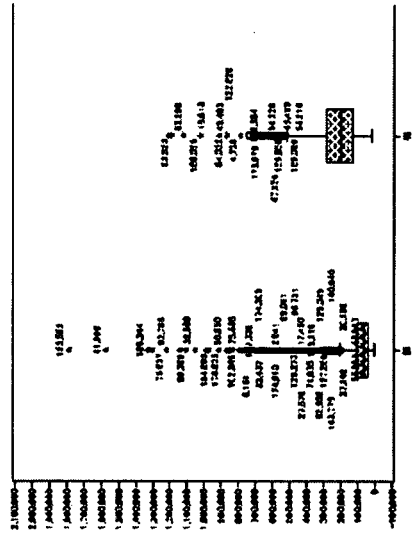
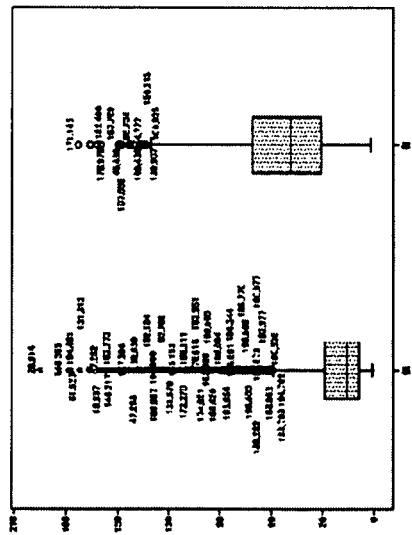

# 图B群(胆汁内瘦)

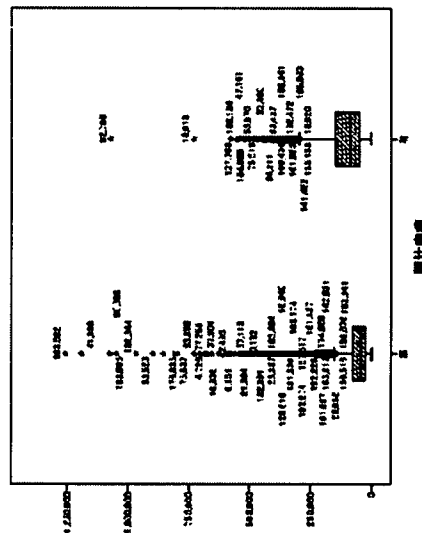
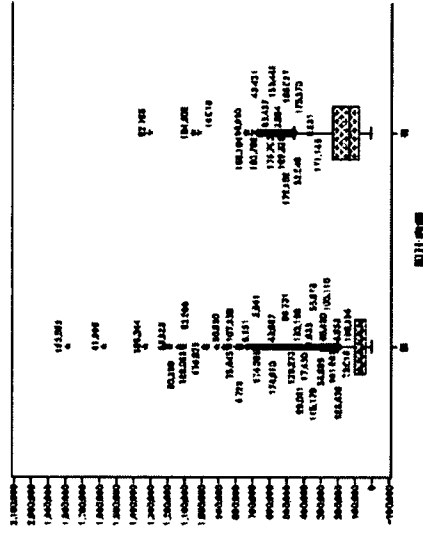
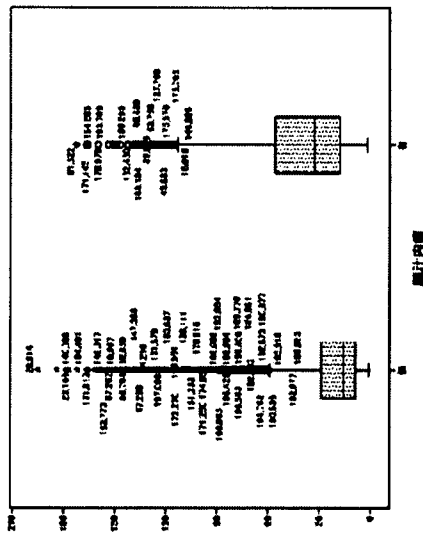

# 図B群(血管塞栓術)

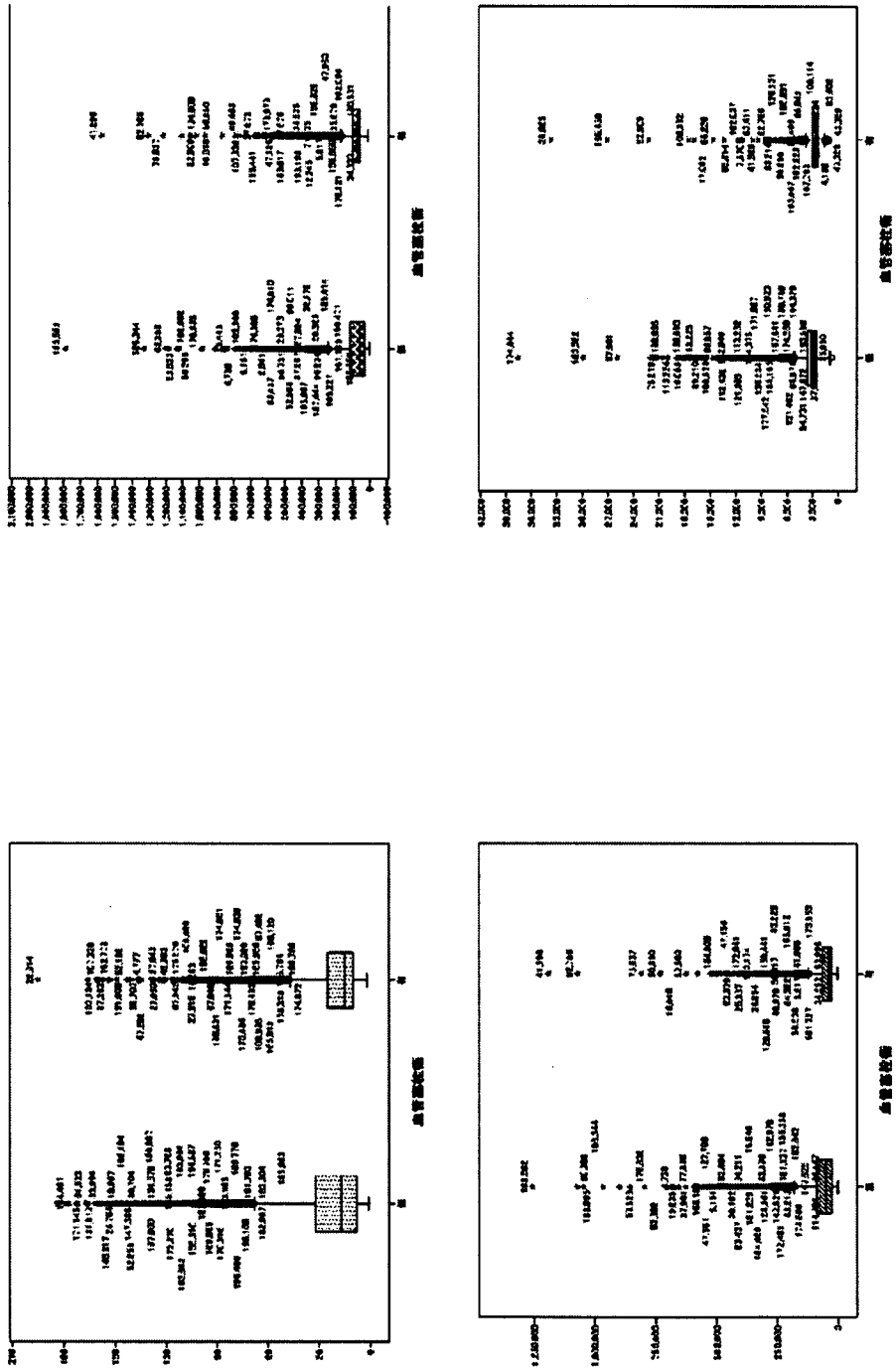



# 図B群(化学療法力于一子ル埋め込み術)

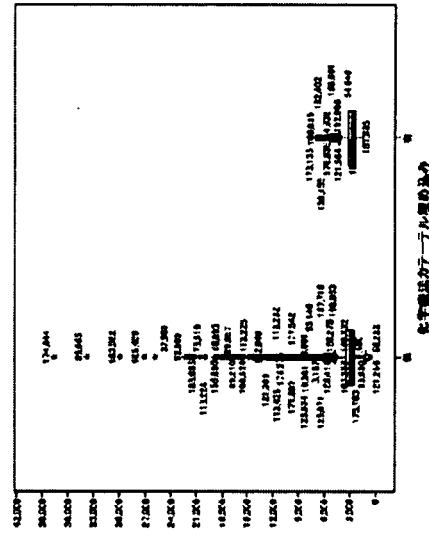
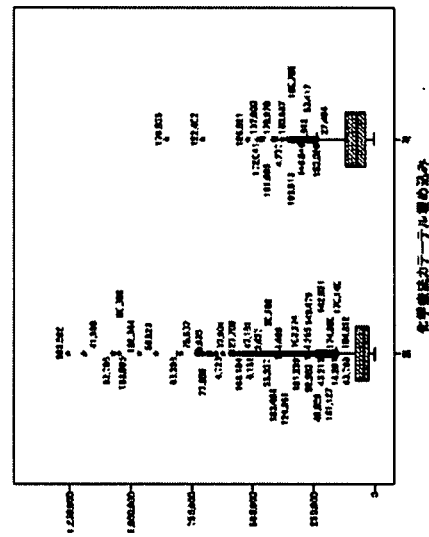
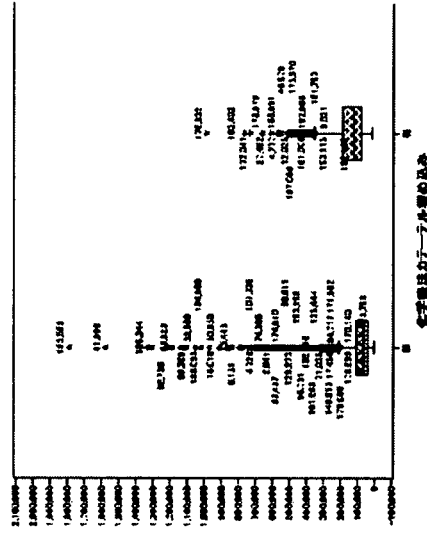
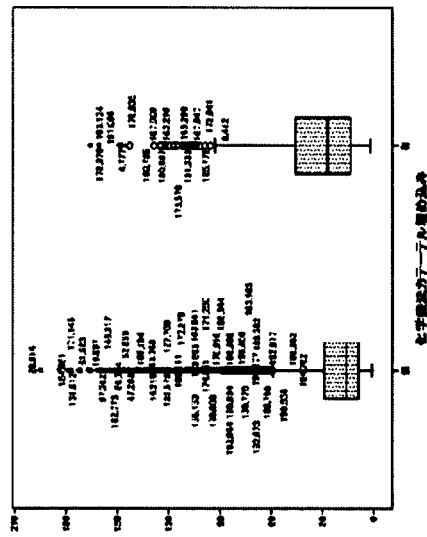

# 図B群(中心静脈力于一テ儿埋め込み術)

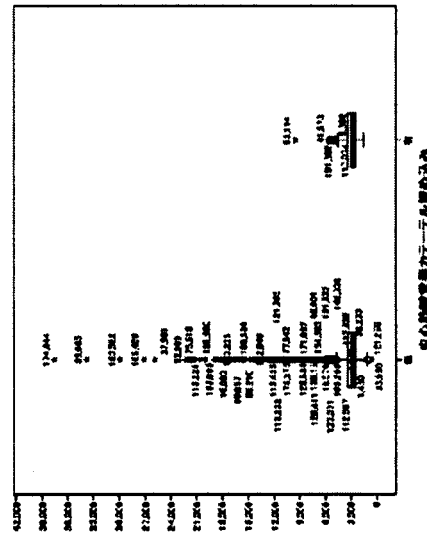
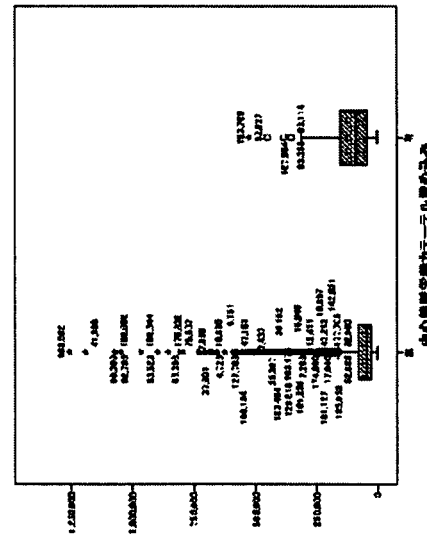
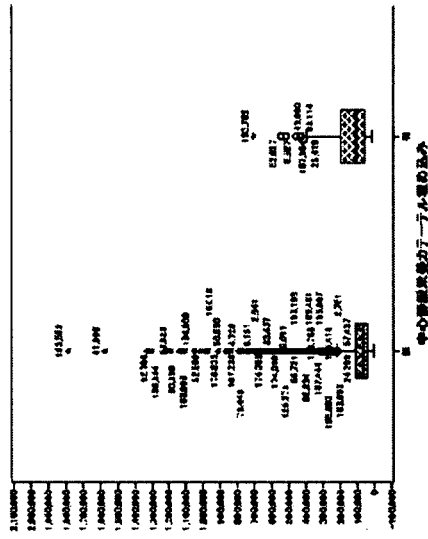
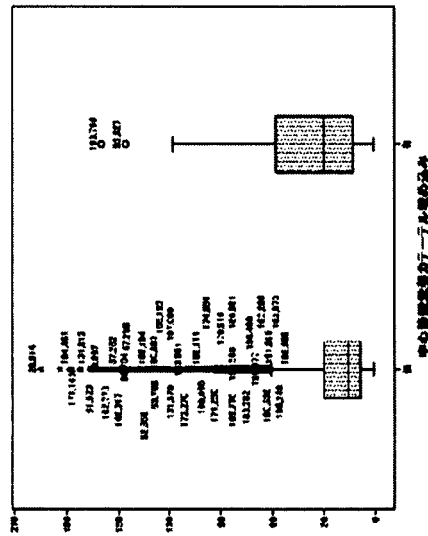

# 図B群(癌補助療法)

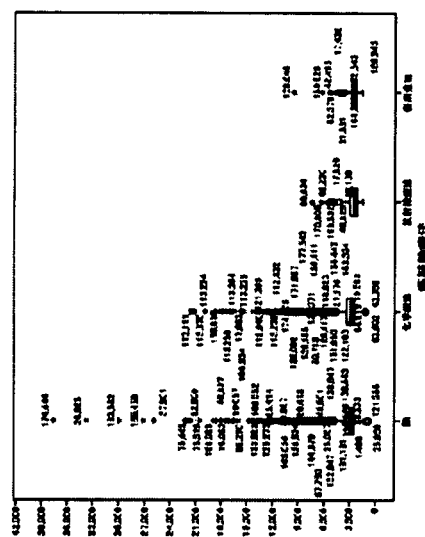
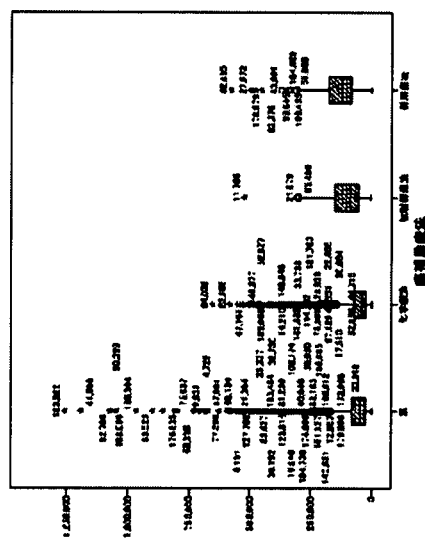
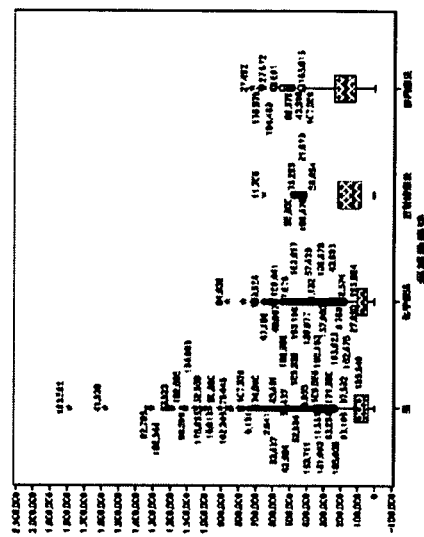
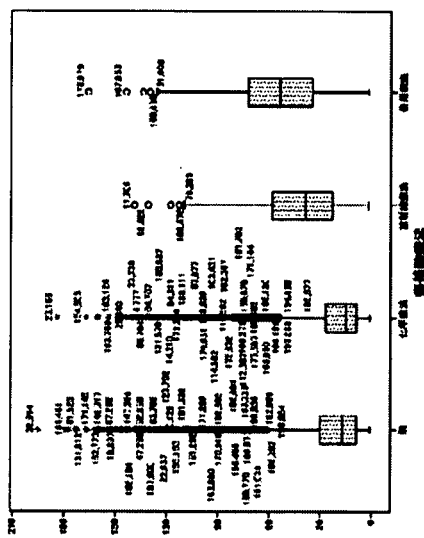

# 図B群(中心静脈)

