

## REGULAR ARTICLE

# Glycomic/glycoproteomic analysis by liquid chromatography/mass spectrometry: Analysis of glycan structural alteration in cells

Noritaka Hashii, Nana Kawasaki, Satsuki Itoh, Mashashi Hyuga, Toru Kawanishi and Takao Hayakawa

Division of Biological Chemistry and Biologicals, National Institute of Health Sciences, Tokyo

The alteration of glycosyltransferase expression and the subsequent changes in oligosaccharide structures are reported in several diseases. The analysis of glycan structural alteration in glycoproteins is becoming increasingly important in the discovery of therapies and diagnostic markers. In this study, we propose a strategy for glycomic/glycoproteomic analysis based on oligosaccharide profiling by LC/MS followed by proteomic approaches, including 2-DE and 2-D lectin blot. As a model of aberrant cells, we used Chinese hamster ovary cells transfected with *N*-acetylglucosaminyltransferase III (GnT-III), which catalyzes the addition of a bisecting *N*-acetylglucosamine (GlcNAc) to  $\beta$ -mannose of the mannosyl core of *N*-linked oligosaccharides. LC/MS equipped with a graphitized carbon column (GCC) enabled us to elucidate the structural alteration induced by the GnT-III expression. Using 2-D lectin blot followed by LC/MS/MS, the protein carrying an extra *N*-acetylhexosamine in cells transfected with GnT-III was successfully identified as integrin  $\alpha 3$ . Thus, oligosaccharide profiling by GCC-LC/MS followed by proteomic methods can be a powerful tool for glycomic/glycoproteomic analysis.

Received: September 20, 2004

Revised: April 22, 2005

Accepted: April 22, 2005

**Keywords:**

2DE / LC/MS / Lectin blotting / Oligosaccharides profiling

## 1 Introduction

It is common knowledge that approximately 50% of proteins in mammalian cells are glycosylated and that glycans play crucial roles in various biological events including cell recognition [1], adhesion [2] and cell-cell interaction [3]. The alteration of glycosyltransferase expression and subsequent changes in oligosaccharide structures are reported in several diseases, including inherited diseases [4], the progression of

cancer [5] and autoimmune diseases [6–8]. The analysis of glycan structural alteration in glycoproteins is becoming increasingly important in the discovery of therapies and diagnostic markers.

Comprehensive analysis of proteins in a given cellular sample is the most effective means of elucidating the disease mechanism. Simultaneous separation and characterization of proteins by 2-DE and 2-D LC followed by MS have been utilized as the fundamental approaches to proteomic analysis; however, these approaches alone are ineffectual for the elucidation of the glycan structural alteration in glycoproteins. A strategy based on qualitative and quantitative glycomic analysis is necessary for the study of glycosylation-associated diseases.

LC/MS is widely used for glycosylation analysis in glycoproteins. Previously, we demonstrated that LC/MS equipped with a graphitized carbon column (GCC-LC/MS) is a useful means of oligosaccharide profiling and for the structural analysis of carbohydrates [9–12]. Using this method, oligosaccharides, including high mannose, hybrid and complex

**Correspondence:** Dr. Nana Kawasaki, 1–18–1, Kamiyoga, Setagaya-ku, Tokyo, 158–8501, Japan

**E-mail:** nana@nihs.go.jp

**Fax:** +81-3-3700-9084

**Abbreviations:** CHO, Chinese hamster ovary; CHO-III cells, CHO cells transfected with *N*-acetylglucosaminyltransferase III; dHex, deoxyhexose; GCC, graphitized carbon column; GlcNAc, *N*-acetylglucosamine; GnT-III, *N*-acetylglucosaminyltransferase III; Hex, hexose; HexNAc, *N*-acetylhexosamine; NeuAc, *N*-acetylneuraminic acid; PNGase F, peptide *N*-glycosidase F

types with or without sialic acids, can be separated, and structural information can be obtained from their mass spectra and chromatographic behavior.

Here we propose a strategy for performing glycomic/glycoproteomic analysis based on a combination of GCC-LC/MS and proteomic approaches.

First, GCC-LC/MS is applied to the analysis of oligosaccharide structural alteration in aberrant cells. Chinese hamster ovary (CHO) cells, used as a model of aberrant cells, were transfected with *N*-acetylglucosaminyltransferase III (GnT-III), which catalyzes the addition of bisecting *N*-acetylglucosamine (GlcNAc) to the trimannosyl core of *N*-linked oligosaccharides [13] and is associated with cell adhesion [14] and the suppression of tumor cell metastasis [15–17]. Then, 2-D lectin blotting followed by LC/MS/MS was used to identify the protein in which glycosylation was altered by the expression of GnT-III.

## 2 Materials and methods

### 2.1 Cell lines and culture

The CHO cells were obtained from the Japanese Collection of Research Bioresources (Tokyo, Japan). The human GnT-III cDNA was cloned into the pCI-neo vector. The expression vector was transfected into CHO cells with LipofectAMINE plus reagent, according to the manufacturer's instructions. To screen the transformants, the transfectants were cultured with Ham's F12 medium supplemented with 10% fetal calf serum (FCS) and 1 mg/mL G418. After 2 weeks, the colonies were lifted with a micropipette. A high GnT-III-expressing clone was used in succeeding experiments.

The CHO cells and GnT-III-transfected CHO cells (CHO-III cells) were cultured in Ham's F12 medium supplemented with 10% FCS, 100 U/mL of penicillin and 100 µg/mL of streptomycin under a humidified atmosphere of 95% air and 5% CO<sub>2</sub>. After harvesting CHO and CHO-III cells, they were rinsed with PBS containing protease inhibitors and 2 mM EDTA.

### 2.2 Preparation of insoluble and soluble fractions

The insoluble and soluble fractions were prepared from CHO and CHO-III cells using a Mem-PER Eukaryotic Membrane Protein Extraction Reagent Kit (Pierce Biotechnology, P.O., USA). The detergent in these fractions was removed with Detergent-OUT (Geno Technology, M.O., USA) three times. For desalting and degreasing, seven volumes of acetone were added to the sample solution, and the mixture was stirred and sonicated. The mixture was then incubated at –20°C for 1 h and centrifuged at 4°C for 15 min, 15 000 × g. The supernatants were discarded, and the pellets dried. The protein concentrations were determined using a BCA protein assay kit (Pierce).

### 2.3 Preparation of *N*-linked oligosaccharide alditols

The protein (500 µg) from each fraction was dissolved in 810 µL of 0.5 M Tris-HCl containing 8 M guanidine-HCl and 5 mM EDTA (pH 8.6), and then 6.0 µL of 2-mercaptoethanol were added in the solution. After incubation at room temperature for 2 h, freshly prepared 0.6 M sodium monoiodoacetamide (135 µL) was added to the solution. After incubation at room temperature for 2 h in the dark, the solution was desalted with PD10 column (Amersham Biosciences, NJ, USA), and the elute was lyophilized. The carboxymethylated proteins were dissolved in 500 µL of 100 mM PBS (pH 7.2), and 20 U of peptide *N*-glycosidase F (PNGase F) (Roche Diagnostics, Mannheim, Germany) were added to the solution. After incubation at 37°C for 4 days, 1.74 mL of cold ethanol was added to the solution, the mixture was incubated at –20°C for 3 h, and proteins were removed by centrifugation at 4°C for 10 min (15 000 × g). The supernatants containing oligosaccharides were evaporated, and then lyophilized. The oligosaccharides were incubated with 500 µL of 0.5 M NaBH<sub>4</sub> at room temperature for 16 h, and then neutralized with 10% (v/v) acetic acid to pH 6.5 and desalted with Envi-Carb (Supelco, Bellefonte, USA).

### 2.4 GCC-LC/MS

LC was carried out using a MAGIC 2002 system (Michrom BioResources, Auburn, CA, USA). The GCC used was a Hypercarb column (150 × 0.2 mm, ThermoFinnigan, San Jose, CA, USA). The eluents were 5 mM ammonium acetate, pH 8.5, containing 2% ACN (pump A) and 5 mM ammonium acetate, pH 8.5, containing 80% ACN (pump B). The borohydride-reduced oligosaccharides were eluted at a flow rate of 2 µL/min with a gradient of 10–45% of pump B in 90 min. Mass spectra were recorded on a TSQ 7000 triple-stage quadrupole mass spectrometer (ThermoFinnigan) equipped with a nano-electrospray ion source (AMR, Inc., Tokyo, Japan). The mass spectrometer was operated in positive ion mode. Ions in the range of *m/z* 900–2400 were acquired with a scan duration of 3 s. The ESI voltage was set at 2.0 kV, and the capillary temperature was 175°C. The electron multiplier was set at 1.0 kV. Collisions for MS/MS were carried out with collision energy of 25%, scan duration of 4 s., and mass range of *m/z* 100–2000.

### 2.5 1-D SDS-PAGE and lectin blotting

Proteins were separated by 1-D SDS-PAGE (12.5% T, 3% C) as described by Laemmli [18] and stained with SYPRO Orange (Bio-Rad, Richmond, CA, USA) at room temperature for 30 min in transfer buffer (25 mM Tris-HCl, 20 mM glycine and 20% methanol). The gel images were scanned on a Typhoon 9400 (Amersham Biosciences) at an excitation wavelength of 540/25 nm and an emission wavelength of 590/30 nm. After saving the gel image, the proteins were blotted to a PVDF membrane (Immun-Blot PVDF membrane,

0.2  $\mu\text{m}$ , Bio-Rad) at 3.0 mA/cm<sup>2</sup>, 20 V for 30 min in transfer buffer containing 0.1% SDS using a semi-dry blotter (Trans-blot SD sel, Bio-Rad). The efficiency and position of the transfer were confirmed using SYPRO Orange transferred together with proteins. Nonspecific sites on the membrane were blocked at 4°C for 16 h in 0.5% casein-PBS. After the membranes were washed with 0.05% Tween-PBS (T-PBS) three times, they were treated with 0.1 U/mL of sialidase (Nacalai Tesque, Kyoto, Japan) at 37°C for 16 h in 0.5 M acetate buffer (pH 5.0). The membranes were then re-blocked with 0.5% casein-PBS at 37°C for 15 min, washed with T-PBS three times, and incubated with biotinylated phytohemagglutinin-E4 (PHA-E4, 2  $\mu\text{g}/\text{mL}$ ) at 4°C for 2 h in PBS (pH 7.4). The membranes were then washed with T-PBS and incubated with 1:1000 diluted avidin-alkaline phosphatase (AP) complex solution at 4°C for 1 h in PBS.

## 2.6 Concentration of target proteins in the gel

The band detected by lectin blotting on 1-D gel was excised and then mashed in 20 mM Tris-HCl (pH 8.0) containing 2% SDS. The proteins in the gel particles were extracted by intermittent sonication at 4°C for 30 min, followed by shaking at room temperature for 16 h. After extraction, the gel particles were removed by centrifugation (15 000  $\times$  g). The proteins in the supernatant were precipitated with sevenfold acetone at -20°C for 3 h, and then the precipitates were washed with acetone three times to remove salts and detergent.

## 2.7 2-DE

For first dimension IEF of the sample, Immobiline DryStrip gel (13 cm, pH4–7 NL, Amersham Biosciences) was used. The samples were dissolved in IEF solution containing 7 M urea, 2 M thiourea, 18 mM DTT, 0.5% IPG buffer, 2% CHAPS, and bromophenol blue. Dried IPG strips were rehydrated overnight in the sample solution. IEF was then performed using the following steps: 500 V for 1 h, 100 V for 1 h, and 8000 V for 2 h, *i.e.* a total of 17.5 kWh.

IPG strips were treated with 10 mL of 50 mM Tris-HCl (pH 8.8) containing 2% SDS, 6 M urea, 30% glycerol and 65 mM DTT for 15 min, and then treated with 10 mL of 50 mM Tris-Cl (pH 8.8) containing 2% SDS, 6 M urea, 30% glycerol and 135 mM iodoacetamide for 15 min in order to reduce the disulfide bonds of cysteinyl residues. SDS-polyacrylamide gels (7.5%T, 3%C, size 140  $\times$  140  $\times$  1 mm) and running buffer containing 25 mM Tris-HCl, 192 mM glycine and 0.1% SDS were used for the 2-DE. The gels were run at 25 mA/gel after setting the IPG strip on the gel. Fluorescent staining and scanning of gel, followed by lectin blotting, were performed as mentioned above. In 2-D lectin blotting, the proteins were blotted to a PVDF membrane at 3.0 mA/cm<sup>2</sup>, 20 V for 90 min.

## 2.8 In-gel digestion and protein identification by LC/MS/MS

Interesting spots were excised from the 2-DE gel for in-gel trypsin digestion. The gel particles were destained with 20 mM ammonium bicarbonate containing 50% methanol in microcentrifuge tubes, and dehydrated in 100% ACN. Enzymatic digestion was performed overnight at 37°C with 5  $\mu\text{L}$  of 20  $\mu\text{g}/\text{mL}$  trypsin (Promega, Madison, WI, USA) in 20 mM ammonium bicarbonate (pH 8.5). Digested peptides were extracted with 1% TFA in 50% ACN, and samples were dried with a Speed-Vac and redissolved in 0.1% TFA for LC/MS.

LC was carried out using a Paradigm MS4 (Michrom BioResources) equipped with Magic C18 column (50  $\times$  0.2 mm, Michrom BioResources). The eluents were 0.1% formic acid containing 2% ACN (pump A), and 0.1% formic acid containing 90% ACN (pump B). The peptides were eluted at a flow rate of 2  $\mu\text{L}/\text{min}$  with a gradient of 5–70% of pump B in 30 min. Mass spectra were recorded on an API QSTAR Pulsar i (Applied Biosystems, Foster City, CA, USA) in the positive ion mode. The proteins were identified by searching the Swiss-Prot database using MASCOT (Matrix Science, UK). The mass range and MS/MS range were  $m/z$  400–2000 and  $m/z$  100–2000, respectively, and the ESI voltage was set at 2.5 kV.

## 3 Results

### 3.1 Analysis of glycans in the insoluble fractions

N-linked oligosaccharides were released from soluble and insoluble fractions by PNGase F and reduced with NaBH<sub>4</sub> to prevent the separation of anomers by GCC. Figure 1A shows the N-linked oligosaccharide profile of the insoluble fraction from CHO cells ( $5 \times 10^7$ ). Diverse oligosaccharide ions were detected by full scan in the positive ion mode of MS. Oligosaccharides were numbered with the labels on peaks where they were detected, and the multiple oligosaccharides in single peak were classified by the digits behind alphabets, such as peaks A1 and A2. Their monosaccharide compositions were deduced from the  $m/z$  values as shown in Table 1. N-linked oligosaccharides from CHO cells have a high proportion of high mannose-type and bi-, tri- and tetra-antennary complex type oligosaccharides [19, 20]. High mannose-type oligosaccharides, [Man]<sub>5–6</sub>[GlcNAc]<sub>2</sub> were detected at 9–23 min (peaks A–E and K). Major components (peaks N2, Q2, R1, S1, T1, U1 and V2) were deduced as fucosylated and non-fucosylated biantennary forms with mono- and di-sialic acids from previous articles and their monosaccharide compositions. Various oligosaccharides, including mono- (peak N1 and Q1), tri- (peak P1, U2, V1), tetra-antennary (peak V3), and hybrid-type (peak F1 and I1) oligosaccharides were detected as minor components together with low molecular weight oligosaccharides such as the trimannosyl core (peaks G1 and O1).

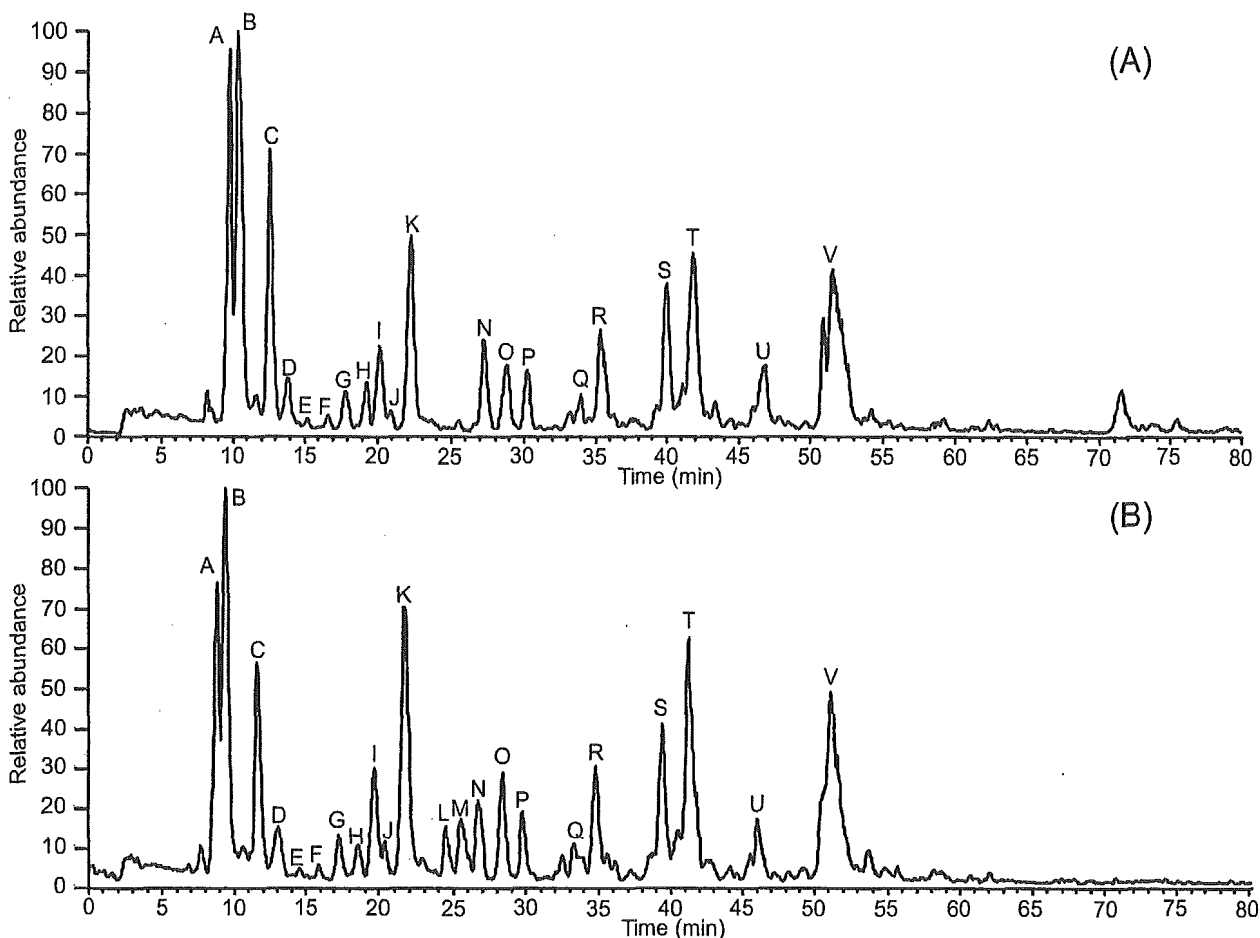

**Figure 1.** Total ion chromatograms of GCC-LC/MS of borohydride-reduced *N*-linked oligosaccharides released from insoluble fraction of CHO (A) and CHO-III (B) in positive ion mode. Pump A: 5 mM ammonium acetate, pH 8.5, containing 2% ACN. Pump B: 5 mM ammonium acetate, pH 8.5, containing 80% ACN. The borohydride-reduced oligosaccharides were eluted at a flow rate of 2  $\mu$ L/min with a gradient of 10–45% of pump B in 90 min.

Figure 1B shows the oligosaccharide profile of the CHO-III-insoluble fraction. The distribution of oligosaccharides in CHO-III was different from that in the CHO cell insoluble fraction. Some additional peaks (peaks L1 and M1) were detected in the CHO-III-insoluble fraction, and their doubly charged ions at  $m/z$  1143.2 and 1143.0 were consistent with the theoretical  $m/z$  values of fucosylated biantennary-bearing NeuAc with one additional HexNAc. Figure 2 shows the MS/MS spectrum of peak M1. Detection of  $B_{17}/Y_6^{2+}$  at  $m/z$  894.1 and an intense ion of  $[\text{HexNAc}]^+$ , at  $m/z$  204 suggest that the oligosaccharide (peak M1) carries one GlcNAc at either of the non-reducing ends. Peak M1 is possibly assigned to bisected biantennary form. In addition, peaks D1, I2 and S2, which were not found in the profile of CHO, were detected in that of CHO-III (Fig. 1B). They can also be deduced as bisected biantennary forms from their MS/MS spectra. Other than these oligosaccharides bearing GlcNAc at either of the non-

reducing ends in CHO-III cells, there was no significant difference in glycosylation between CHO and CHO-III cells. These results suggest that only limited oligosaccharides are altered by the expression of GnT-III.

### 3.2 Analysis of glycans in the soluble fractions

Figure 3A and B shows the *N*-linked oligosaccharide profiles of the soluble fractions of CHO and CHO-III, respectively. The oligosaccharide components of soluble fractions are very different from those of insoluble fractions (Table 1). High mannose-type oligosaccharides,  $[\text{Man}]_{5-9}[\text{GlcNAc}]_2$ , were detected as major components (peaks A–C and K), and complex-type and hybrid-type oligosaccharides were detected as minor oligosaccharides in the soluble fraction. Oligosaccharides bearing extra GlcNAc (D1, L1 and M1) were also detected in the soluble fraction of CHO-III.

**Table 1.** Observed *m/z* values and carbohydrate compositions of peaks A–V in total ion chromatogram 3 of CHO-insoluble (Fig. 1A), CHO-III-insoluble (Fig. 1B), CHO-soluble (Fig. 3A) and CHOIII-soluble (Fig. 3B) fractions

Carbohydrate composition <sup>a)</sup>	Theoretical mass <sup>b)</sup>	Peak No.	Insoluble fraction				Soluble fraction			
			CHO		CHO-III		CHO		CHO-III	
			Charge state	Observed <i>m/z</i>	Charge state	Observed <i>m/z</i>	Charge state	Observed <i>m/z</i>	Charge state	Observed <i>m/z</i>
[Hex] <sub>7</sub> [HexNAc] <sub>2</sub>	1561.4	A A1	H <sup>+</sup>	1562.2	H <sup>+</sup>	1562.0	Na <sup>+</sup>	1584.4	Na <sup>+</sup>	1584.2
[Hex] <sub>8</sub> [HexNAc] <sub>2</sub>	1723.5	A2	Na <sup>+</sup>	1746.3	Na <sup>+</sup>	1746.3	Na <sup>+</sup>	1746.5	Na <sup>+</sup>	1746.1
[Hex] <sub>9</sub> [HexNAc] <sub>2</sub>	1885.7	B B1	Na <sup>+</sup>	1908.4	Na <sup>+</sup>	1908.5	Na <sup>+</sup>	1908.4	Na <sup>+</sup>	1908.9
[Hex] <sub>5</sub> [HexNAc] <sub>2</sub>	1399.3	C C1	H <sup>+</sup>	1400.1	H <sup>+</sup>	1400.0	H <sup>+</sup>	1399.7	H <sup>+</sup>	1399.9
[Hex] <sub>7</sub> [HexNAc] <sub>2</sub>	1561.4	C2	Na <sup>+</sup>	1584.2	Na <sup>+</sup>	1584.0	Na <sup>+</sup>	1584.8	Na <sup>+</sup>	1584.0
[dHex] <sub>1</sub> [Hex] <sub>5</sub> [HexNAc] <sub>5</sub>	1992.9	D D1		N.D. <sup>c)</sup>	2H <sup>+</sup>	<b>997.4</b>		N.D.	2H <sup>+</sup>	<b>997.5</b>
[Hex] <sub>6</sub> [HexNAc] <sub>2</sub>	1399.3	D2	Na <sup>+</sup>	1422.0	Na <sup>+</sup>	1421.9		N.D.		N.D.
[Hex] <sub>7</sub> [HexNAc] <sub>2</sub>	1561.4	D3	Na <sup>+</sup>	1584.2	Na <sup>+</sup>	1584.1		N.D.		N.D.
[Hex] <sub>8</sub> [HexNAc] <sub>2</sub>	1723.5	D4	Na <sup>+</sup>	1746.2	Na <sup>+</sup>	1746.4		N.D.		N.D.
[Hex] <sub>4</sub> [HexNAc] <sub>2</sub>	1075.0	E E1	Na <sup>+</sup>	1097.9	Na <sup>+</sup>	1097.6		N.D.		N.D.
[Hex] <sub>6</sub> [HexNAc] <sub>2</sub>	1399.3	E2	H <sup>+</sup>	1400.1	H <sup>+</sup>	1400.0		N.D.		N.D.
[Hex] <sub>6</sub> [HexNAc] <sub>3</sub>	1602.5	F F1	H <sup>+</sup>	1604.0	H <sup>+</sup>	1603.1		N.D.		N.D.
[Hex] <sub>3</sub> [HexNAc] <sub>2</sub>	912.8	G G1	H <sup>+</sup>	913.7	H <sup>+</sup>	913.7	Na <sup>+</sup>	935.7	Na <sup>+</sup>	935.6
[Hex] <sub>5</sub> [HexNAc] <sub>4</sub>	1643.5	H H1	H <sup>+</sup>	1644.5	H <sup>+</sup>	1644.2	Na <sup>+</sup>	1666.3	Na <sup>+</sup>	1666.4
[Hex] <sub>6</sub> [HexNAc] <sub>4</sub>	1827.6	I I1	2Na <sup>+</sup>	914.7	2Na <sup>+</sup>	914.7		N.D.		N.D.
[Hex] <sub>5</sub> [HexNAc] <sub>5</sub> [NeuAc] <sub>1</sub>	2137.9	I2		N.D.	2H <sup>+</sup>	<b>1069.8</b>		N.D.		N.D.
[dHex] <sub>1</sub> [Hex] <sub>5</sub> [HexNAc] <sub>4</sub>	1465.4	J J1	H <sup>+</sup>	1466.1	H <sup>+</sup>	1466.1	Na <sup>+</sup>	1488.2	Na <sup>+</sup>	1487.9
[Hex] <sub>5</sub> [HexNAc] <sub>2</sub>	1237.1	K K1	H <sup>+</sup>	1238.0	H <sup>+</sup>	1238.0	H <sup>+</sup>	1237.9	H <sup>+</sup>	1237.9
[dHex] <sub>1</sub> [Hex] <sub>5</sub> [HexNAc] <sub>5</sub> [NeuAc] <sub>1</sub>	2284.1	L L1		N.D.	2H <sup>+</sup>	<b>1143.2</b>		N.D.	2H <sup>+</sup>	<b>1142.9</b>
[dHex] <sub>1</sub> [Hex] <sub>5</sub> [HexNAc] <sub>5</sub> [NeuAc] <sub>1</sub>	2284.1	M M1		N.D.	2H <sup>+</sup>	<b>1143.0</b>		N.D.	2H <sup>+</sup>	<b>1143.3</b>
[dHex] <sub>1</sub> [Hex] <sub>4</sub> [HexNAc] <sub>3</sub>	1424.3	N N1	H <sup>+</sup>	1425.4	H <sup>+</sup>	1425.3	Na <sup>+</sup>	1447.1	Na <sup>+</sup>	1447.1
[dHex] <sub>1</sub> [Hex] <sub>5</sub> [HexNAc] <sub>4</sub>	1789.7	N2	H <sup>+</sup>	1790.1	H <sup>+</sup>	1790.3	Na <sup>+</sup>	1812.3	Na <sup>+</sup>	1812.1
[dHex] <sub>1</sub> [Hex] <sub>5</sub> [HexNAc] <sub>2</sub>	1059.0	O O1	H <sup>+</sup>	1059.7	H <sup>+</sup>	1059.7	H <sup>+</sup>	1059.8	H <sup>+</sup>	1059.7
[dHex] <sub>1</sub> [Hex] <sub>5</sub> [HexNAc] <sub>5</sub>	2155.0	P P1	2H <sup>+</sup>	1078.5	2H <sup>+</sup>	1078.5		N.D.		N.D.
[dHex] <sub>1</sub> [Hex] <sub>3</sub> [HexNAc] <sub>3</sub>	1262.2	Q Q1	H <sup>+</sup>	1263.0	H <sup>+</sup>	1263.0		N.D.		N.D.
[Hex] <sub>5</sub> [HexNAc] <sub>4</sub> [NeuAc] <sub>1</sub>	1934.7	Q2	2H <sup>+</sup>	968.4	2H <sup>+</sup>	968.4		N.D.		N.D.
[Hex] <sub>5</sub> [HexNAc] <sub>4</sub> [NeuAc] <sub>1</sub>	1934.7	R R1	2H <sup>+</sup>	968.4	2H <sup>+</sup>	968.4	2H <sup>+</sup>	968.7	2H <sup>+</sup>	968.2
[dHex] <sub>1</sub> [Hex] <sub>5</sub> [HexNAc] <sub>4</sub> [NeuAc] <sub>1</sub>	2080.9	S S1	2H <sup>+</sup>	1041.4	2H <sup>+</sup>	1041.4	2H <sup>+</sup>	1041.4	2H <sup>+</sup>	1041.3
[dHex] <sub>1</sub> [Hex] <sub>5</sub> [HexNAc] <sub>5</sub> [NeuAc] <sub>2</sub>	2574.0	S2		N.D.	2H <sup>+</sup>	<b>1288.5</b>		N.D.		N.D.
[dHex] <sub>1</sub> [Hex] <sub>5</sub> [HexNAc] <sub>4</sub> [NeuAc] <sub>1</sub>	2080.9	T T1	2H <sup>+</sup>	1041.4	2H <sup>+</sup>	1041.5	2H <sup>+</sup>	1041.4	2H <sup>+</sup>	1041.3
[Hex] <sub>5</sub> [HexNAc] <sub>4</sub> [NeuAc] <sub>2</sub>	2226.0	U U1	2H <sup>+</sup>	1114.0	2H <sup>+</sup>	1113.9	2H <sup>+</sup>	1113.9	2H <sup>+</sup>	1113.9
[dHex] <sub>1</sub> [Hex] <sub>5</sub> [HexNAc] <sub>5</sub> [NeuAc] <sub>1</sub>	2446.2	U2	2H <sup>+</sup>	1224.2	2H <sup>+</sup>	1224.3	2Na <sup>+</sup>	1124.9		N.D.
[dHex] <sub>1</sub> [Hex] <sub>5</sub> [HexNAc] <sub>5</sub> [NeuAc] <sub>2</sub>	2737.5	V V1	2H <sup>+</sup>	1370.0	2H <sup>+</sup>	1370.0		N.D.		N.D.
[dHex] <sub>1</sub> [Hex] <sub>5</sub> [HexNAc] <sub>4</sub> [NeuAc] <sub>2</sub>	2372.1	V2	2H <sup>+</sup>	1187.1	2H <sup>+</sup>	1187.1	2H <sup>+</sup>	1187.2	2H <sup>+</sup>	1187.2
[dHex] <sub>1</sub> [Hex] <sub>7</sub> [HexNAc] <sub>6</sub> [NeuAc] <sub>1</sub>	2811.6	V3	2H <sup>+</sup>	1406.8	2H <sup>+</sup>	1406.6		N.D.		N.D.

The characteristic *m/z* values observed in total ion chromatograms of CHO-III are depicted in bold type.

a) [dHex], deoxyhexose; [Hex], hexose; [HexNAc], *N*-acetylhexosamine; [NeuAc], *N*-acetylneuraminic acid.

b) Monoisotopic mass values.

c) Not detected.

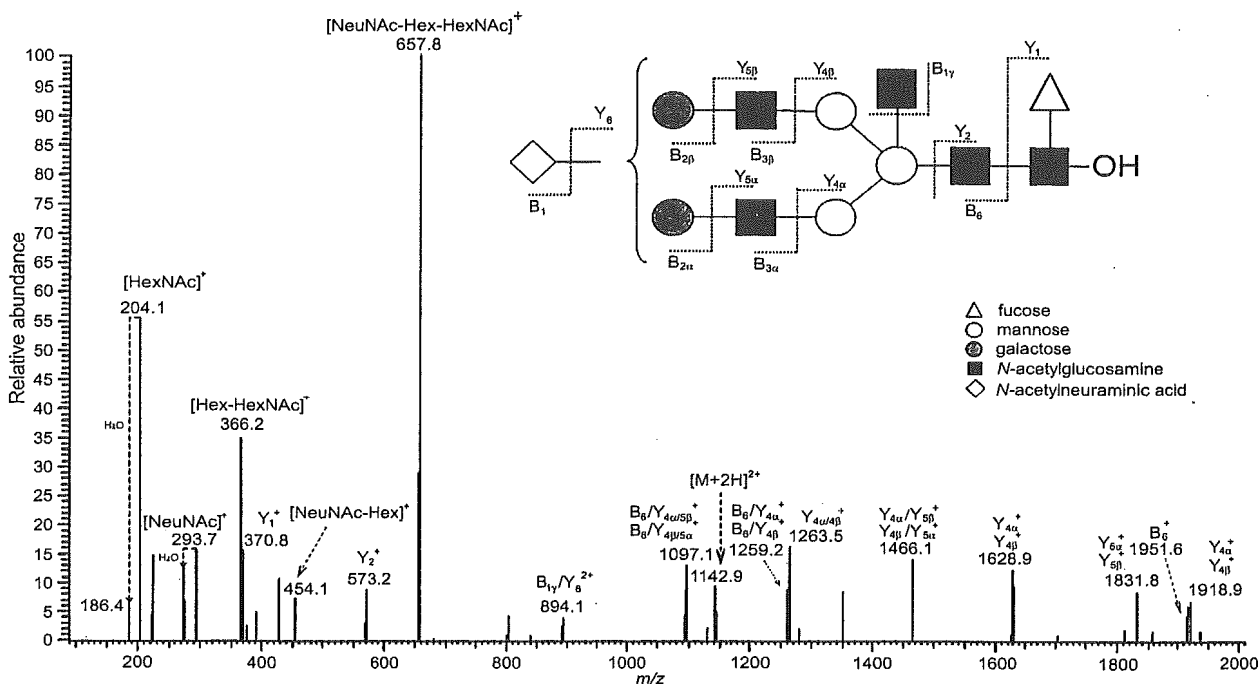

**Figure 2.** MS/MS spectrum of fucosylated biantennary N-linked oligosaccharide (peak M1) detected in the insoluble fraction from CHO-III.

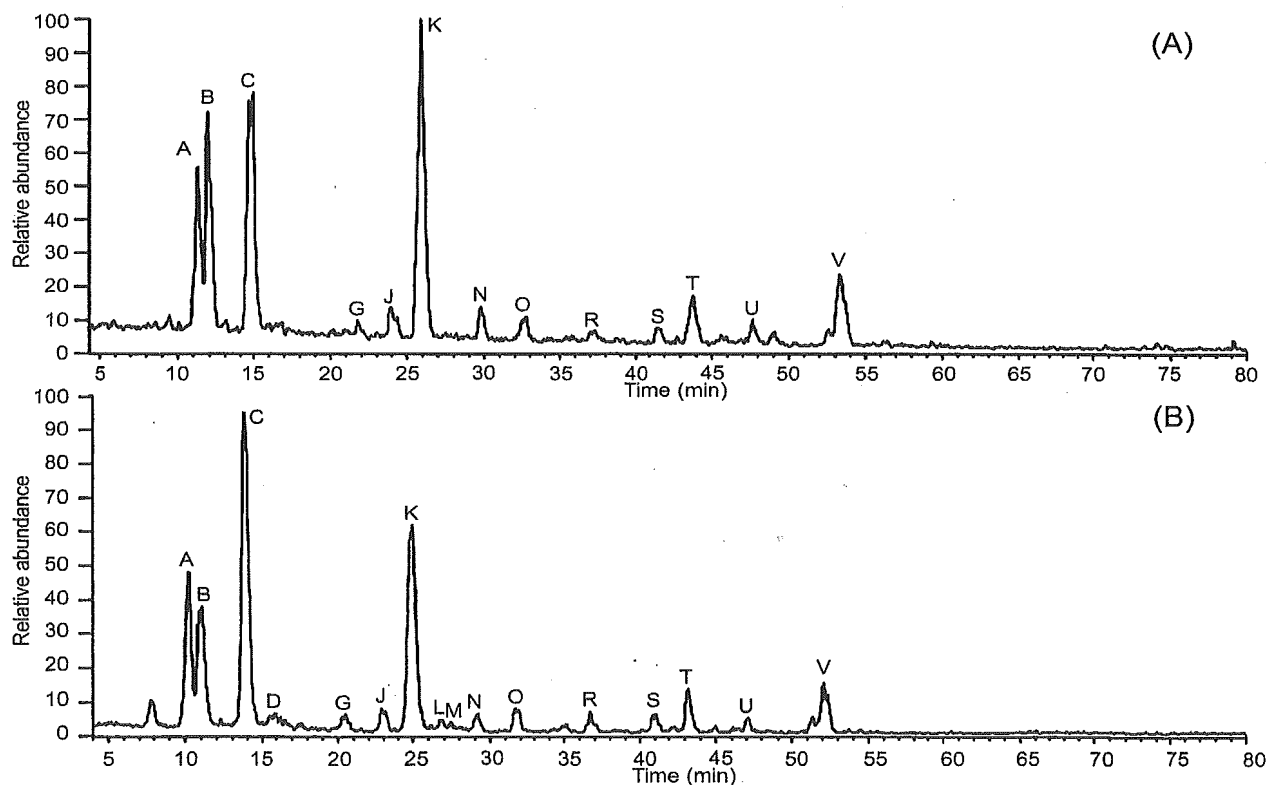

**Figure 3.** Total ion chromatograms of GCC-LC/MS of borohydride-reduced N-linked oligosaccharides released from the soluble fractions of CHO (A) and CHO-III (B) in positive ion mode. Pump A: 5 mM ammonium acetate, pH 8.5, containing 2% ACN. Pump B: 5 mM ammonium acetate, pH 8.5, containing 80% ACN. The borohydride-reduced oligosaccharides were eluted at a flow rate of 2  $\mu$ L/min with a gradient of 10–45% of pump B in 90 min.

### 3.3 Identification of protein bearing bisected oligosaccharides

To identify proteins with altered glycans by the expression of GnT-III, we performed 2-DE followed by lectin blotting using PHA-E4 lectin, which recognizes bisecting GlcNAc in complex-type oligosaccharides. Although some bisected glycoproteins (70–120 kDa) could be visualized by 2-D lectin blotting, their expressions were too low to be detected on 2-DE gel. Lectin affinity chromatography, which is generally used for the concentration of glycoproteins, cannot be used for the insoluble fraction due to the presence of detergent in the solvent medium. Therefore, we first performed 1-D SDS-PAGE followed by lectin blotting, and then proteins in the range of 70–120 kDa were extracted from the gel (Fig. 4). 2-DE followed by lectin blotting was then performed, and interesting spots were successfully detected on 2-DE gel. Figure 5A and B shows the 2-DE gel images and the 2-D lectin blot of extracted proteins, respectively. The remarkable train spots (120 Da) of glycoprotein were picked up and in-gel digested with trypsin. The digest was subjected to LC/MS/MS, and the integrin  $\alpha 3$  precursor was identified as the GnT-III target protein.

## 4 Discussion

The development of a simple and rapid method to explore glycan structural alteration in a complex mixture is required to elucidate the mechanisms of diseases involving glycan alteration. In this study, we demonstrated that GCC-LC/MS, which is used for glycosylation analysis in glycoproteins, is

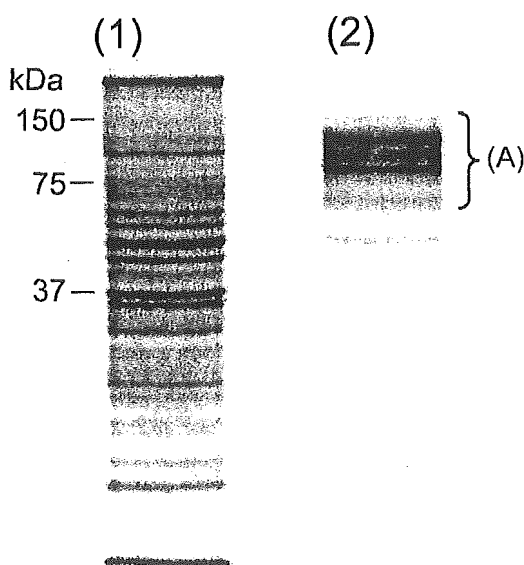

**Figure 4.** (1) 1-D SDS-PAGE and (2) lectin blot images of the CHO-III insoluble fraction. Proteins were separated on a 12.5% SDS-PAGE gel and stained with SYPRO Orange.

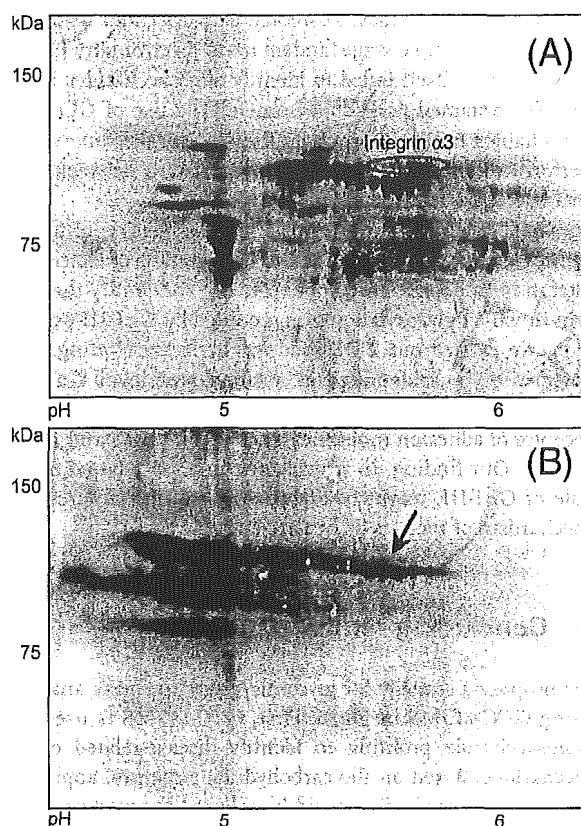

**Figure 5.** Enlarged partial (A) 2-DE and (B) lectin blot images from band A in Fig. 4.

applicable for the exploration of changes in glycosylation between samples. Using GCC-LC/MS, high mannose, hybrid, and complex types as well as neutral and acidic oligosaccharides could be separated and characterized by a single analysis. GCC-LC/MS clearly shows differences in glycosylation between soluble and insoluble fractions. High mannose-type oligosaccharides were detected as major components in the soluble fraction. The soluble fraction contains endoplasmic reticulum and Golgi apparatus, where *N*-linked oligosaccharides are constructed. The predominance of high-mannose-type oligosaccharides in the soluble fraction may be the cause of immature oligosaccharides in the process of biosynthesis. In contrast, complex and hybrid types with or without sialic acids were detected in the insoluble fraction, suggesting that membrane proteins carry mature oligosaccharides.

In addition, GCC-LC/MS revealed differences in glycosylation between control cells and aberrant model cells. Biantennary forms bearing extra GlcNAc were obviously increased in cells transfected with the GnT-III gene, indicating that our methodology allows us to explore changes in the glycosyltransferase expression followed by glycan alteration. Although MS is frequently used for the analysis of glycosylation, identification of oligosaccharide isomers by MS alone

still remains challenges. Positional isomers could be differentiated by multiple-stage tandem mass spectrometry (MS<sup>n</sup>); however, MS<sup>n</sup> itself failed to identify oligosaccharides if the sample contained positional isomers. The use of GCC-LC/MS enables us to differentiate the structural isomers and perform differential analysis in glycosylation between normal and aberrant cells.

GnT-III is reported to involve the suppression of tumor cell metastasis and is assumed to be a marker of cancerous alteration in hepatic carcinoma [21, 22]. To identify the protein in which glycosylation was modified by GnT-III expression, we carried out 2-DE followed by lectin blotting, and Integrin  $\alpha$ 3 was identified as a target protein of GnT-III. Integrin  $\alpha$ 3, a type I membrane protein, is known to be a receptor of adhesion molecules, such as laminin 5 and 10/11 [23–25]. Our finding, in which integrin  $\alpha$ 3 is a target molecule of GnT-III, might be a clue to clarify the suppression mechanism of metastasis by GnT-III.

## 5 Concluding remarks

We propose a strategy for glycomic/glycoproteomic analysis using GCC-LC/MS in Fig. 6. First, GCC-LC/MS is used for oligosaccharide profiling to identify disease-related oligosaccharides. Based on the carbohydrate structure, appropriate lectins or antibodies could be selected for western blotting. Proteins carrying disease-related oligosaccharides could then be identified by 2-D lectin blotting followed by MS/MS analysis. Using several groups, 2-D lectin blotting has been proposed for the characterization of glycoproteins on gel [26, 27]. The use of mass spectrometric oligosaccharide profiling, which can directly characterize glycan structures, is worthwhile to obtain structural information about disease-related carbohydrate and is helpful in the subsequent choice of appropriate lectins and antibodies. Our method is expected to be a powerful tool for glycomic/glycoproteomic analysis.

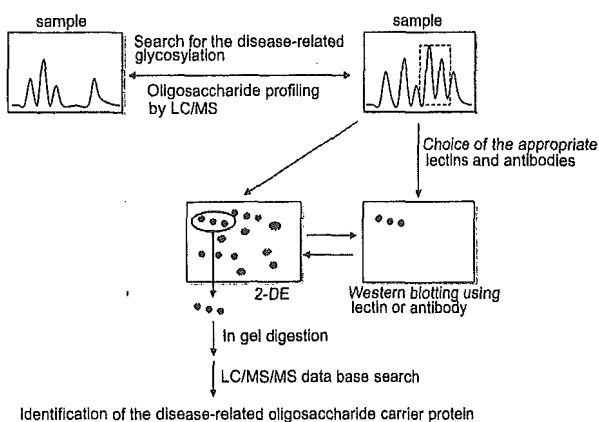

**Figure 6.** Strategy for glycomics/glycoproteomics using GCC-LC/MS, 2-DE and 2-D Western blotting using lectin or antibody.

## 6 References

- [1] Varki, A., *Glycobiology* 1993, 3, 97–130.
- [2] Isaji, T., Gu, J., Nishiuchi, R., Zhao, Y. *et al.*, *J. Biol. Chem.* 2004, 279, 19747–19754.
- [3] Stanley, P., *Biochim. Biophys. Acta* 2002, 1573, 363–368.
- [4] Schachter, H., *Cell Mol. Life Sci.* 2001, 58, 1085–1104.
- [5] Dennis, J. W., Granovsky, M., Warren, C.E., *Biochim. Biophys. Acta* 1999, 1473, 21–34.
- [6] Delves, P. J., *Autoimmunity* 1998, 27, 239–253.
- [7] Gleeson, P. A., *Biochim. Biophys. Acta* 1994, 1197, 237–255.
- [8] Chui, D., Sellakumar, G., Green, R., Sutton-Smith, M. *et al.*, *Proc. Natl. Acad. Sci. USA* 2001, 98, 1142–1147.
- [9] Itoh, S., Kawasaki, N., Ohta, M., Hyuga, M. *et al.*, *J. Chromatogr. A* 2002, 968, 89–100.
- [10] Kawasaki, N., Haishima, Y., Ohta, M., Itoh, S. *et al.*, *Glycobiology* 2001, 11, 1043–1049.
- [11] Kawasaki, N., Ohta, M., Itoh, S., Hyuga, M. *et al.*, *Biologicals* 2002, 30, 113–123.
- [12] Davies, M., Smith, K. D., Harbin, A. M., Hounsell, E. F., *J. Chromatogr.* 1992, 609, 125–131.
- [13] Narasimhan, S., *J. Biol. Chem.* 1982, 257, 10235–10242.
- [14] Yoshimura, M., Ihara, Y., Matsuzawa, Y., Taniguchi, N., *J. Biol. Chem.* 1996, 271, 13811–13815.
- [15] Taniguchi, N., Miyoshi, E., Ko, J. H., Ikeda, Y., Ihara, Y., *Biochim. Biophys. Acta* 1999, 1455, 287–300.
- [16] Yoshimura, M., Nishikawa, A., Ihara, Y., Taniguchi, S., Taniguchi, N., *Proc. Natl. Acad. Sci. USA* 1995, 92, 8754–8758.
- [17] Bhaumik, M., Harris, T., Sundaram, S., Johnson, L. *et al.*, *Cancer Res.* 1998, 58, 2881–2887.
- [18] Laemmli, U. K., *Nature* 1970, 227, 680–685.
- [19] Stanley, S., Sundaram, S., Tang, J., Shi, S., *Glycobiology* 2005, 15, 43–53.
- [20] Lee, J., Sundaram, S., Shaper, N. L., Raju, S., Stanley, P., *J. Biol. Chem.* 2001, 276, 13924–13934.
- [21] Yamashita, K., Koide, N., Endo, T., Iwaki, Y., Kobata, A., *J. Biol. Chem.* 1989, 264, 2415–2423.
- [22] Yamashita, K., Hitoi, A., Taniguchi, N., Yokosawa, N. *et al.*, *Cancer Res.* 1983, 43, 5059–5063.
- [23] Carter, W. G., Ryan, M. C., Gahr, P. J., *Cell* 1991, 65, 599–610.
- [24] Kikkawa, Y., Umeda, M., Miyazaki, K., *J. Biochem (Tokyo)* 1994, 116, 862–869.
- [25] Kikkawa, Y., Sanzen, N., Sekiguchi, K., *J. Biol. Chem.* 1998, 273, 15854–15859.
- [26] Kim, Y. S., Hwang, S. Y., Oh, S., Shon, H. *et al.*, *Proteomics* 2004, 4, 3353–3358.
- [27] Rahman, M. A., Karsani, S. A., Othman, I., Rahman, P. S. A., Hashim, O. H., *Biochem. Biophys. Res. Commun.* 2002, 295, 1007–1013.



# Specific detection of Lewis x-carbohydrates in biological samples using liquid chromatography/multiple-stage tandem mass spectrometry

Noritaka Hashii<sup>1,2</sup>, Nana Kawasaki<sup>1,2\*</sup>, Satsuki Itoh<sup>1</sup>, Akira Harazono<sup>1</sup>, Yukari Matsuishi<sup>1,2</sup>, Takao Hayakawa<sup>3</sup> and Toru Kawanishi<sup>1</sup>

<sup>1</sup>Division of Biological Chemistry and Biologicals, National Institute of Health Sciences, 1-18-1 Kamiyoga, Setagaya-ku, Tokyo 158-8501, Japan

<sup>2</sup>Core Research for Evolutional Science and Technology (CREST) of Japan Science and Technology Agency (JST), Kawaguchi Center Building, 4-1-8 Hon-cho, Kawaguchi, Saitama 332-0012, Japan

<sup>3</sup>Pharmaceutical and Medical Devices Agency, 3-3-2 Kasumigaseki, Chiyoda-ku, Tokyo 100-0013, Japan

Received 14 July 2005; Revised 5 September 2005; Accepted 8 September 2005

The Lewis x structure [Le<sup>x</sup>, Gal $\beta$ 1-4(Fuc $\alpha$ 1-3)GlcNAc] motif is one of the tumor antigens and plays an important role in oncogenesis, development, cellular differentiation and adhesion. The detection of Le<sup>x</sup>-carbohydrates and their structural analysis are necessary to clarify the role of Le<sup>x</sup> in several biological events. Mass spectrometry has been preferably used for the structural analysis of carbohydrates. Especially, collision-induced dissociation (CID) tandem mass spectrometry (MS/MS), which causes a glycosidic bond cleavage, is used for carbohydrate sequencing. However, Le<sup>x</sup> cannot be identified by MS/MS due to the existence of the positional isomers, such as Lewis a [Gal $\beta$ 1-3( $\alpha$ 1-4Fuc)GlcNAc]. In the present study, we demonstrate the specific detection of Le<sup>x</sup>-carbohydrates in a biological sample by using multiple-stage MS/MS (MS<sup>n</sup>). Using pyridylaminated oligosaccharides bearing Le<sup>x</sup>, we found that the Le<sup>x</sup>-motif yields a cross-ring fragment by the cleavage of a bond between C-3 and C-4 of GlcNAc in Gal(Fuc)GlcNAc. The Le<sup>x</sup>-specific cross-ring fragment ion at *m/z* 259 was effectively detected by sequential scans, consisting of a full MS<sup>1</sup> scan, data-dependent CID MS<sup>2</sup> scan, MS<sup>3</sup> of [Gal(Fuc)GlcNAc+Na]<sup>+</sup> at *m/z* 534, and MS<sup>4</sup> of [GalGlcNAc+Na]<sup>+</sup> at *m/z* 388. The sequential scan was applied to *N*-linked oligosaccharide profiling using a LC/ESI-MS<sup>n</sup> system equipped with a graphitized carbon column. We successfully detected the Le<sup>x</sup>-motif and elucidated the structures of several Le<sup>x</sup> and Lewis y [(Fuc $\alpha$ 1-2)Gal $\beta$ 1-4(Fuc $\alpha$ 1-3)GlcNAc] oligosaccharides in the murine kidney used as a model tissue. Our method is expected to be a powerful tool for the specific detection of the Le<sup>x</sup>-motif, and structural elucidation of Le<sup>x</sup>-carbohydrates in biological samples. Copyright © 2005 John Wiley & Sons, Ltd.

The Lewis x structure [Le<sup>x</sup>, Gal $\beta$ 1-4(Fuc $\alpha$ 1-3)GlcNAc] is one of the tumor antigens, and plays an important role in oncogenesis<sup>1,2</sup> (abbreviations used here are: Gal, galactose; Fuc, fucose; GlcNAc, *N*-acetylglucosamine). Particularly, sialylated Le<sup>x</sup> is used as a marker of lung, pancreas and uterus tumors.<sup>3</sup> Le<sup>x</sup> and its derivatives are also known to be oligosaccharide ligands of some endothelial receptors, such as the selectins and the scavenger receptor, C-type lectin,<sup>4,5</sup> and affect embryonic development, cellular differentiation and adhesion.<sup>6,7</sup> However, the structural details of the oligosaccharides attached to the Le<sup>x</sup> structure (Le<sup>x</sup>-oligosaccharide) are still unclear. Le<sup>x</sup> structure-specific detection and elucidation

methods are necessary for the diagnosis of tumors and a study on the role of Le<sup>x</sup> on various biological events.

Mass spectrometry (MS) has become very popular for the structural analysis of oligosaccharides. Low-energy collision-induced dissociation (CID) tandem mass spectrometry (MS/MS), which generates B/Y-series ions by glycosidic bond cleavage, is preferably used for oligosaccharide sequencing.<sup>8–13</sup> However, the detection of Le<sup>x</sup> by MS/MS is still challenging due to the presence of its positional isomer, Lewis a [Le<sup>a</sup>, Gal $\beta$ 1-3(Fuc $\alpha$ 1-4)GlcNAc]. The structural difference between Le<sup>x</sup> and Le<sup>a</sup> is the linkage at positions 3 or 4 of the non-reducing terminal fucose and galactose to GlcNAc (Fig. 1). For the linkage analysis, multiple-stage MS/MS (MS<sup>n</sup>) pattern-matching, in which the oligosaccharide structure can be deduced from intensity ratios of fragment ions generated by MS<sup>n</sup>, has recently been reported,<sup>14–16</sup> however, this method needs an identical analytical condition and various oligosaccharide standards. As an alternative method, the cross-ring fragmentation caused by MS<sup>n</sup> is

\*Correspondence to: N. Kawasaki, Division of Biological Chemistry and Biologicals, National Institute of Health Sciences, 1-18-1 Kamiyoga, Setagaya-ku, Tokyo 158-8501, Japan.

E-mail: nana@nihs.go.jp

Contract/grant sponsor: Ministry of Health Labor and Welfare, and Core Research for the Evolutional Science and Technology Program, Japan Science and Technology Corp.

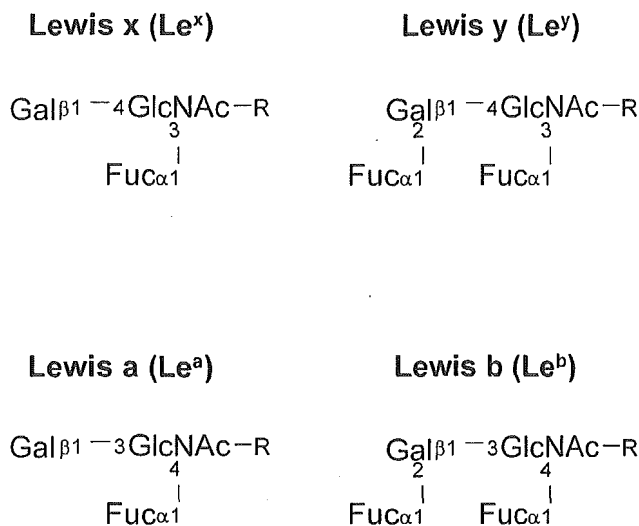

**Figure 1.** Structures of Lewis a, b, x and y.

sometimes used.<sup>10,17,18</sup> Meisen *et al.*<sup>19</sup> demonstrated that  $\alpha$ 2-6-linked *N*-acetylneuraminic acid (NeuNAc) can be distinguished from  $\alpha$ 2-3-linked NeuNAc based on structure-specific cross-ring fragment ions generated by low-energy CID MS<sup>2</sup> in the negative ion mode. Le<sup>x</sup> could be expected to be distinguished from its positional isomers by cross-ring fragmentation.

In this study, we demonstrate the specific detection of Le<sup>x</sup>-carbohydrates in a biological sample by using MS<sup>n</sup>. Using pyridylaminated oligosaccharides bearing Le<sup>x</sup>, we found that the Le<sup>x</sup>-motif yields a cross-ring fragment by the cleavage of a bond between C-3 and C-4 of GlcNAc in Gal(Fuc)GlcNAc. The Le<sup>x</sup>-specific cross-ring fragment ion at *m/z* 259 was effectively detected by sequential scans, consisting of a full MS<sup>1</sup> scan, data-dependent CID MS<sup>2</sup> scan, MS<sup>3</sup> of [Gal(Fuc)GlcNAc+Na]<sup>+</sup> at *m/z* 534, and MS<sup>4</sup> of [GalGlcNAc+Na]<sup>+</sup> at *m/z* 388 using nano-electrospray ionization-ion trap mass spectrometry (nanoESI-ITMS) in positive ion mode. Then, sequential MS<sup>1-4</sup> scanning for the Le<sup>x</sup>-characteristic ions was applied for *N*-linked oligosaccharide profiling using an LC/ESI-ITMS instrument equipped with a graphitized carbon column (GCC), by which diverse oligosaccharides, including isomers, can be separated. We successfully detected the Le<sup>x</sup>-motif and subsequently elucidated the entire structure of Le<sup>x</sup>-oligosaccharides in the model tissue, murine kidney, in which Le<sup>x</sup>-oligosaccharides are abundantly present.<sup>20</sup>

## EXPERIMENTAL

### Materials

2-Aminopyridine (PA)-labeled pentasaccharides bearing Le<sup>x</sup> (oligosaccharide I, Fig. 2(A)) or Le<sup>a</sup> (oligosaccharide II, Fig. 2(B)), and the asialotriantennary oligosaccharide bearing Le<sup>x</sup> (oligosaccharide III, Fig. 2(C)), were purchased from Takara Biomedicals (Otsu, Japan). Murine kidneys (MRL/MpJ-+/+) were purchased from Japan SLC Inc. (Hamamatsu, Japan).

### Sample preparation

Proteins from murine kidneys were solubilized in lysis buffer (7 M urea, 2 M thiourea, 2% CHAPS, 30 mM Tris-HCl) by vor-

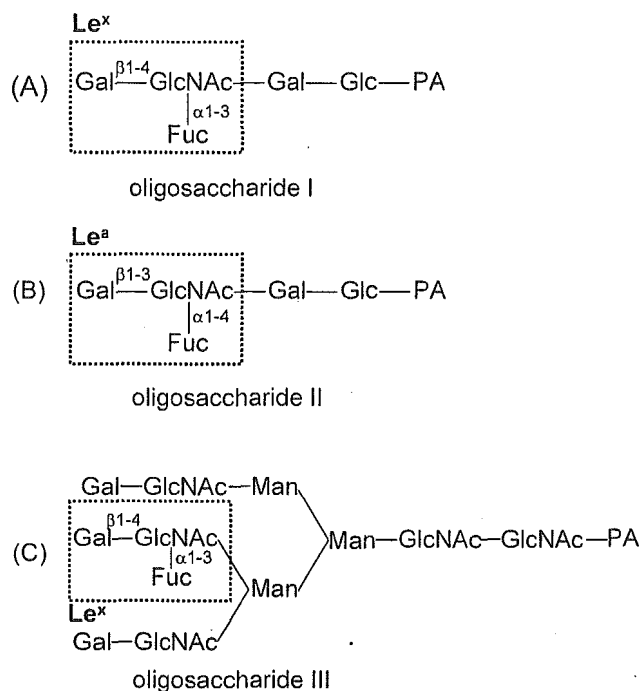

**Figure 2.** Structures of model oligosaccharides used in this study: (A) PA-labeled Le<sup>x</sup>-pentasaccharide (oligosaccharide I); (B) PA-labeled Le<sup>a</sup>-pentasaccharide (oligosaccharide II); and (C) PA-labeled Le<sup>x</sup>-asialotriantennary complex type oligosaccharide (oligosaccharide III).

texing at room temperature. The proteins (100  $\mu$ g) were recovered by precipitation in cold acetone, and then treated with 10 units of PNGase F in 500  $\mu$ L of 0.2 M phosphate buffer (pH 7.6) at 37°C for 48 h to release the *N*-linked oligosaccharides. Proteins were removed by precipitation in cold ethanol, and the supernatant containing oligosaccharides was evaporated and lyophilized. The dried oligosaccharides were labeled with PA according to a previous report.<sup>21</sup> The PA-labeled oligosaccharides were desalted with Envi-Carb C (Supelco Bellefonte, USA) and lyophilized.

### nanoESI-MS<sup>n</sup>

Experiments were performed using a Finnigan linear ion trap Fourier transform ion cyclotron resonance mass spectrometer (LTQ-FT, ThermoElectron, San Jose, CA, USA) equipped with a nanoESI source (AMR, Inc., Tokyo, Japan). ESI-MS<sup>n</sup> was carried out for Le<sup>x</sup>- and Le<sup>a</sup>-oligosaccharide standards at a concentration of 1 pmol/ $\mu$ L in 5 mM ammonium acetate and 10  $\mu$ M NaCl buffer (pH 9.6) containing 50% acetonitrile. The sample was analyzed at a flow rate of 2.0  $\mu$ L/min using a spray voltage of 2.0 kV in the positive ion mode. The capillary temperature was set to 200°C; collision energies were set to 20–30% for the MS<sup>n</sup> experiments; the maximum scan time was set to 50 ms. MS<sup>2</sup> and MS<sup>3</sup> were performed with an isolation width of 3.0 u (range of precursor ion  $\pm$ 1.5).

### LC/MS<sup>n</sup>

LC was carried out using a MAGIC 2002 system (Michrom BioResources, Auburn, CA, USA) equipped with a GCC (Hypercarb column, 150  $\times$  0.2 mm, ThermoElectron). The

eluent were 5 mM ammonium acetate, pH 9.6, containing 2% acetonitrile (pump A) and 5 mM ammonium acetate, pH 9.6, containing 80% acetonitrile (pump B). PA-labeled *N*-linked oligosaccharides from murine kidney were eluted at a flow rate of 2  $\mu$ L/min with a gradient of 10–70% of pump B in 60 min. A solution of NaCl (10  $\mu$ M) was passed post-column at a flow rate of 2  $\mu$ L/min. The precursor ions detected by a full MS<sup>1</sup> scan (mass range at  $m/z$  750–2000) were followed by MS<sup>2</sup> scans of the most intense ions.

## RESULTS AND DISCUSSION

### MS<sup>n</sup> of Le<sup>x</sup>-pentaoligosaccharide

The model Le<sup>x</sup>-pentaoligosaccharide (oligosaccharide I) was analyzed by nanoESI-MS<sup>n</sup> with direct injection in the positive ion mode. Sodium chloride (NaCl) was deliberately added to the sample for the acceleration of the cross-ring cleavages according to previous reports.<sup>22–24</sup> The sodiated singly charged molecular ion, [M+Na]<sup>+</sup>, of oligosaccharide I was observed at  $m/z$  954.4 in the MS<sup>1</sup> spectrum (Fig. 3(A)). MS<sup>2</sup> of the sodiated molecular ion yielded [(M+Na)-Fuc]<sup>+</sup> at  $m/z$  808 as the most intense ion by the glycosidic bond cleavage between GlcNAc and Fuc residues (Fig. 3(B)). This indicates that the Fuc residue is easily dissociated by low-energy CID MS<sup>2</sup>. In addition to the defucosylated ions, we observed the sodiated ion at  $m/z$  534, corresponding to the Le<sup>x</sup> and Le<sup>a</sup> structure, [Gal(Fuc)GlcNAc+Na]<sup>+</sup>. The sodiated B<sub>2</sub> ion ( $m/z$  534) was subjected to a further product ion scan, and the sodiated ion at  $m/z$  388 corresponding to [GalGlcNAc+Na]<sup>+</sup> appeared in the MS<sup>3</sup> spectrum (Fig. 3(C)). The ion at  $m/z$  372, corresponding to [FucGlcNAc+Na]<sup>+</sup>, which proves the attachment of Fuc to GlcNAc, was also detected. Then, MS<sup>4</sup>

of the sodiated Y<sub>3 $\alpha$</sub>  ion ( $m/z$  388) yielded a sodiated cross-ring fragment ion at  $m/z$  259, corresponding to the sodiated <sup>3,5</sup>A<sub>2</sub> ion, which proves the linkage of the Gal residue at position C-4 on GlcNAc, with some neutral losses: 60 Da (<sup>0,4</sup>A<sub>2</sub>, <sup>0,4</sup>X<sub>4 $\beta$</sub> , <sup>1,3</sup>X<sub>4 $\beta$</sub>  and <sup>2,4</sup>X<sub>4 $\beta$</sub> ) and 90 Da (<sup>0,3</sup>A<sub>2</sub> and <sup>1,4</sup>X<sub>4 $\beta$</sub> ) (Fig. 3(D)).

### MS<sup>n</sup> of Le<sup>a</sup>-pentaoligosaccharide

The Le<sup>a</sup>-pentaoligosaccharide (oligosaccharide II) was subjected to nanoESI-MS<sup>n</sup> in a similar manner. The [M+Na]<sup>+</sup> of oligosaccharide II was observed at  $m/z$  954.4 in the MS<sup>1</sup> spectrum (Fig. 4(A)). MS<sup>2</sup> of the [M+Na]<sup>+</sup> at  $m/z$  954 yielded the sodiated ion at  $m/z$  534, corresponding to [Gal(Fuc)GlcNAc+Na]<sup>+</sup> (Fig. 4(B)). MS<sup>3</sup> of the sodiated B<sub>2</sub> ion ( $m/z$  534) yielded the sodiated Y<sub>3 $\alpha$</sub>  and Y<sub>3 $\beta$</sub>  ions at  $m/z$  372 and 388, respectively (Fig. 4(C)). MS<sup>4</sup> of the sodiated Y<sub>3 $\beta$</sub>  ion at  $m/z$  388 yielded some cross-ring fragment ions at  $m/z$  208, 268, 298 and 328, corresponding to neutral losses: 60 Da (<sup>0,4</sup>A<sub>2</sub>, <sup>0,4</sup>X<sub>4 $\beta$</sub> , <sup>1,3</sup>X<sub>4 $\beta$</sub>  and <sup>2,4</sup>X<sub>4 $\beta$</sub> ) and 90 Da (<sup>0,3</sup>A<sub>2</sub>, <sup>0,3</sup>X<sub>4 $\beta$</sub>  and <sup>1,4</sup>X<sub>4 $\beta$</sub> ) (Fig. 4(D)). <sup>3,5</sup>A<sub>2</sub> at  $m/z$  259, which arose from oligosaccharide I, was not detected by MS<sup>4</sup> of Le<sup>a</sup>.

These results suggest that the Le<sup>x</sup> structure can be identified by the <sup>3,5</sup>A<sub>2</sub> ion at  $m/z$  259 generated by MS<sup>4</sup> of [GalGlcNAc+Na]<sup>+</sup> at  $m/z$  388, which arose from MS<sup>3</sup> of [Gal(Fuc)GlcNAc+Na]<sup>+</sup> at  $m/z$  534 (Fig. 5).

### MS<sup>n</sup> of Le<sup>x</sup>-asialotriantennary oligosaccharide

Using a Le<sup>x</sup>-oligosaccharide with a more complicated branching structure, we confirmed the practicability of MS<sup>3</sup> of the ion at  $m/z$  534 followed by MS<sup>4</sup> of the ion at  $m/z$  388 for the detection of the Le<sup>x</sup>-diagnostic ion at  $m/z$  259.

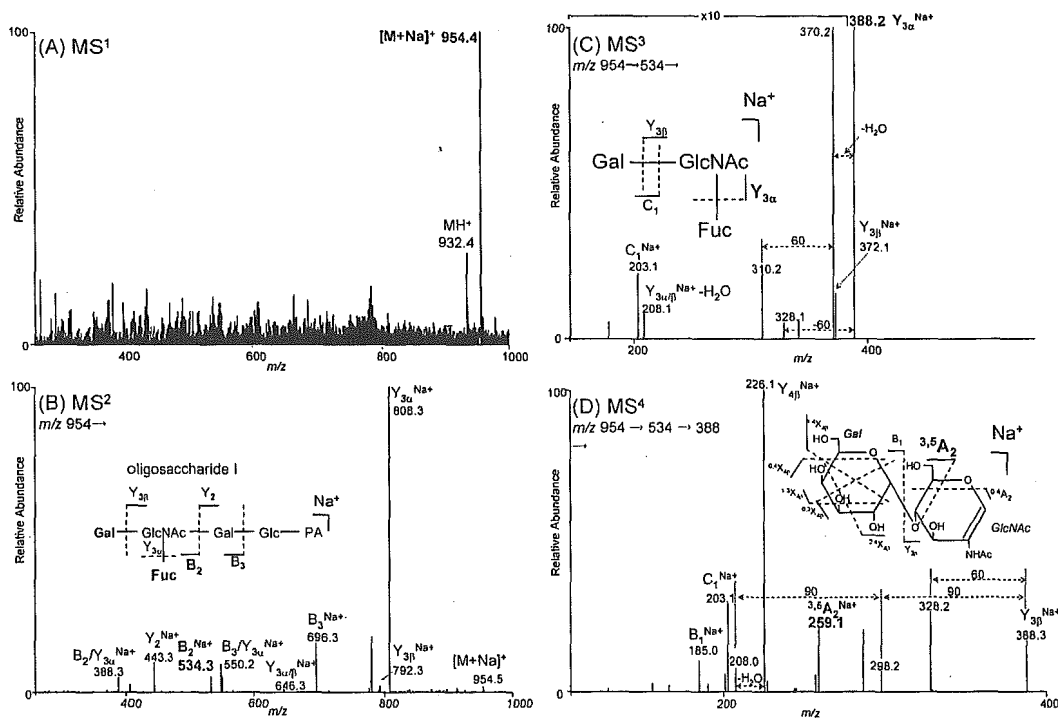

**Figure 3.** MS<sup>1–4</sup> spectra of oligosaccharide I by ESI-MS<sup>n</sup>: (A) MS<sup>1</sup> spectrum; (B) MS<sup>2</sup> spectrum of [M+Na]<sup>+</sup> at  $m/z$  954.4; (C) MS<sup>3</sup> spectrum of [Gal(Fuc)GlcNAc+Na]<sup>+</sup> at  $m/z$  534.3 detected in MS<sup>2</sup>; and (D) MS<sup>4</sup> spectrum of [GalGlcNAc+Na]<sup>+</sup> at  $m/z$  388.2 detected in MS<sup>3</sup>.



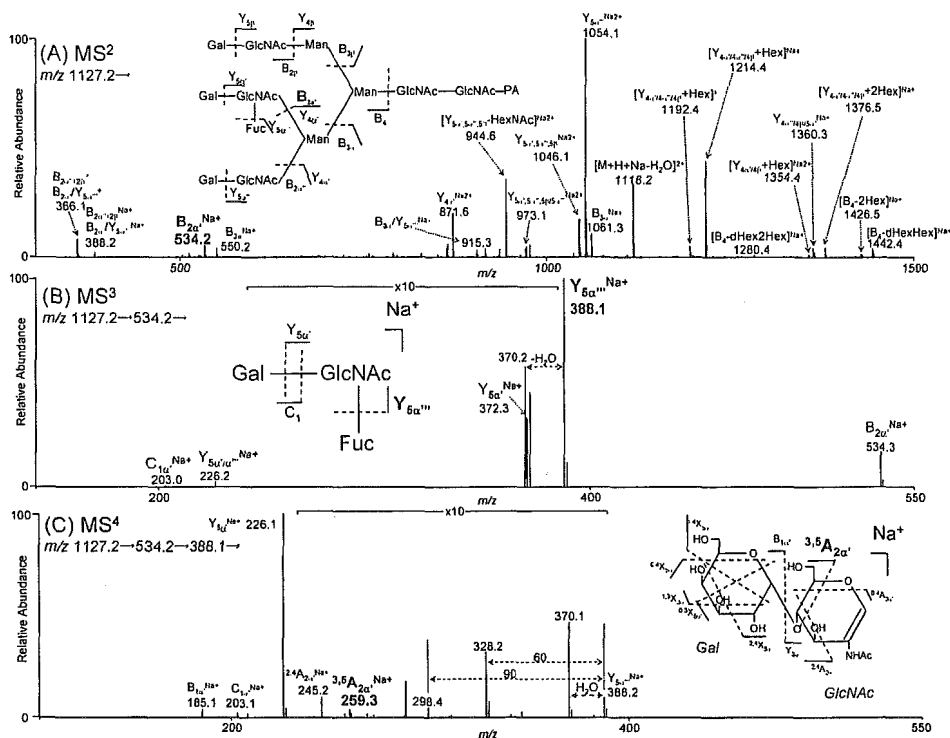
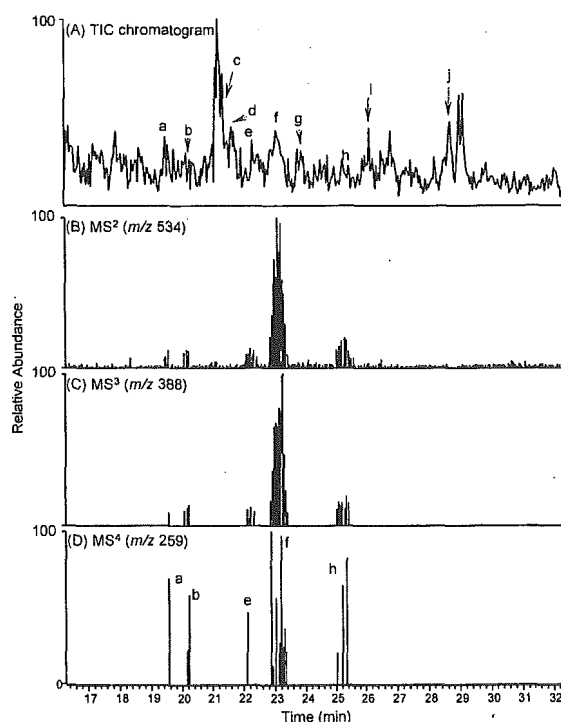

**Figure 6.** MS<sup>2-4</sup> spectra of oligosaccharide III by ESI-MS<sup>n</sup>: (A) MS<sup>2</sup> spectrum of [M+H+Na]<sup>2+</sup> at *m/z* 1127.2; (B) MS<sup>3</sup> spectrum of [Gal(Fuc)GlcNAc+Na]<sup>+</sup> at *m/z* 534.2 detected in MS<sup>2</sup>; and (C) MS<sup>4</sup> spectrum of [GalGlcNAc+Na]<sup>+</sup> at *m/z* 388.1 detected in MS<sup>3</sup>.

diagnostic ions by MS<sup>1-4</sup> scans were presumed to be those of Le<sup>x</sup>-oligosaccharides, and their detailed structures were elucidated by their data-dependent MS<sup>2</sup> spectra.

Figure 7(A) shows the total ion current (TIC) profile obtained by the full MS<sup>1</sup> scan of PA-labeled oligosaccharides from the murine kidney. Structures of major oligosaccharides a–i were deduced from the masses of the sodiated molecular ions measured by FTMS together with the B/Y ions generated by CID MS<sup>2</sup> (Table 1). Figures 7(B)–7(D) show mass chromatograms at *m/z* 534, 388 and 259, respectively, detected by MS<sup>2-4</sup>, respectively. These chromatograms revealed that at least five kinds of oligosaccharides contain the Le<sup>x</sup>-motif (a, b, e, f and h). Based on the masses, they were assigned to fucosylated oligosaccharides consisting of dHex<sub>3</sub>Hex<sub>5</sub>HexNac<sub>5</sub> (a and f), dHex<sub>2</sub>Hex<sub>5</sub>HexNac<sub>5</sub> (b), dHexHex<sub>4</sub>HexNac<sub>5</sub> (e), and dHex<sub>2</sub>Hex<sub>4</sub>HexNac<sub>5</sub> (h) (abbreviations used here are: dHex, deoxyhexose; Hex, hexose; HexNac, *N*-acetylhexosamine).

As an example of structural elucidation, we show the MS<sup>2-4</sup> spectra of oligosaccharide f in Fig. 8. In the MS<sup>2</sup> spectrum, we can observe the product ion [dHex<sub>2</sub>HexHexNac+Na]<sup>+</sup> at *m/z* 680, which can be assigned to either the Lewis b (Le<sup>b</sup>)- or Lewis y (Le<sup>y</sup>)-motif. As shown in Fig. 1, Le<sup>b</sup>- and Le<sup>y</sup>-motifs contain Le<sup>a</sup> and Le<sup>x</sup> as partial structures, respectively. The generation of Le<sup>x</sup>-diagnostic ions suggests the attachment of the Le<sup>y</sup>-motif to oligosaccharide f. Furthermore, product ions at *m/z* 1036 and 446 prove the linkage of GlcNAc at  $\beta$ -mannose in the trimannosyl core structure and fucosylation of the reducing terminal GlcNAc, respectively. Based on these characteristic ions, oligosaccharide f can be assigned to the bisected and fucosylated biantennary bearing the



**Figure 7.** Specific detection of *N*-linked Le<sup>x</sup>-oligosaccharides in murine kidney by LC/ESI-MS<sup>n</sup>: (A) total ion chromatogram obtained by MS<sup>1</sup>; (B) mass chromatogram of [dHexHexNac+Na]<sup>+</sup> at *m/z* 534 detected in MS<sup>2</sup>; (C) mass chromatogram of [HexHexNac+Na]<sup>+</sup> at *m/z* 388 detected in MS<sup>3</sup>; and (D) mass chromatogram of the cross-ring fragment at *m/z* 259 detected in MS<sup>4</sup>.

**Table 1.** Sugar composition and deduced structure of *N*-linked oligosaccharide from murine kidney

Sugar No.	Composition <sup>a</sup>	Deduced structure	Lewis type
a	dHex <sub>3</sub> Hex <sub>5</sub> HexNAC <sub>5</sub>		Le <sup>y</sup>
b	dHex <sub>2</sub> Hex <sub>5</sub> HexNAC <sub>5</sub>		Le <sup>x</sup>
c	Hex <sub>8</sub> HexNAC <sub>2</sub>		
d	Hex <sub>9</sub> HexNAC <sub>2</sub>		
e	dHexHex <sub>4</sub> HexNAC <sub>5</sub>		Le <sup>x</sup>
f	dHex <sub>3</sub> Hex <sub>5</sub> HexNAC <sub>5</sub>		Le <sup>y</sup>
g	Hex <sub>6</sub> HexNAC <sub>2</sub>		
h	dHex <sub>2</sub> Hex <sub>4</sub> HexNAC <sub>5</sub>		Le <sup>x</sup>
i	Hex <sub>7</sub> HexNAC <sub>2</sub>		
j	Hex <sub>5</sub> HexNAC <sub>2</sub>		

<sup>a</sup>Fuc, fucose; Hex, hexose; HexNAC, *N*-acetylhexosamine.

○ Gal; ○ Man; ■ GlcNAC; △ Fuc.

Le<sup>y</sup>-motif. The Le<sup>y</sup> structure in oligosaccharide *f* was confirmed by an extra LC/MS<sup>2</sup> run without post-column reaction with NaCl. Figure 9 shows the MS<sup>2</sup> spectrum of [M+H+NH<sub>4</sub>]<sup>2+</sup> at *m/z* 1189.4. Attachment of the Le<sup>y</sup>-motif was proved by the generation of the product ion at *m/z* 658 corresponding to [dHex<sub>2</sub>HexHexNAC]<sup>+</sup>.

Other oligosaccharides were assigned to bisected bian-tennary forms bearing Le<sup>y</sup> (oligosaccharide *a*) and those bearing Le<sup>x</sup> (oligosaccharides *b*, *e* and *h*) motifs. In addition to the previously reported Le<sup>x</sup>-oligosaccharides,<sup>20</sup> we also detected the presence of Le<sup>y</sup>-oligosaccharides in the murine kidney.

## CONCLUSIONS

We found that the cross-ring fragment ion at *m/z* 259, which can be used for distinction from positional isomers, was generated from Le<sup>x</sup>-oligosaccharides by MS<sup>4</sup> of [GalGlcNAC+Na]<sup>+</sup> at *m/z* 388, which was generated by MS<sup>3</sup> of [Gal(Fuc)GlcNAC+Na]<sup>+</sup> at *m/z* 534. Then, we successfully detected and elucidated the Le<sup>x</sup>- and Le<sup>y</sup>-oligosaccharides in the complex mixture using a sequential scan consisting of full MS<sup>1</sup>, data-dependent MS<sup>2</sup>, MS<sup>3</sup> of the sodiated ion at *m/z* 534, and MS<sup>4</sup> of the sodiated ion at *m/z* 388.

The Le<sup>x</sup> structure is associated with various biological events as oligosaccharide ligands. So far, the detection and structural analyses of Le<sup>x</sup>-oligosaccharides have required complicated and time-consuming processes, such as exoglycosidase digestions, sugar mapping,<sup>27</sup> the use of lectins and immunological methods. The mass spectrometric method proposed here would enable the rapid and easy detection of the Le<sup>x</sup>-motif and subsequent structural elucidation of

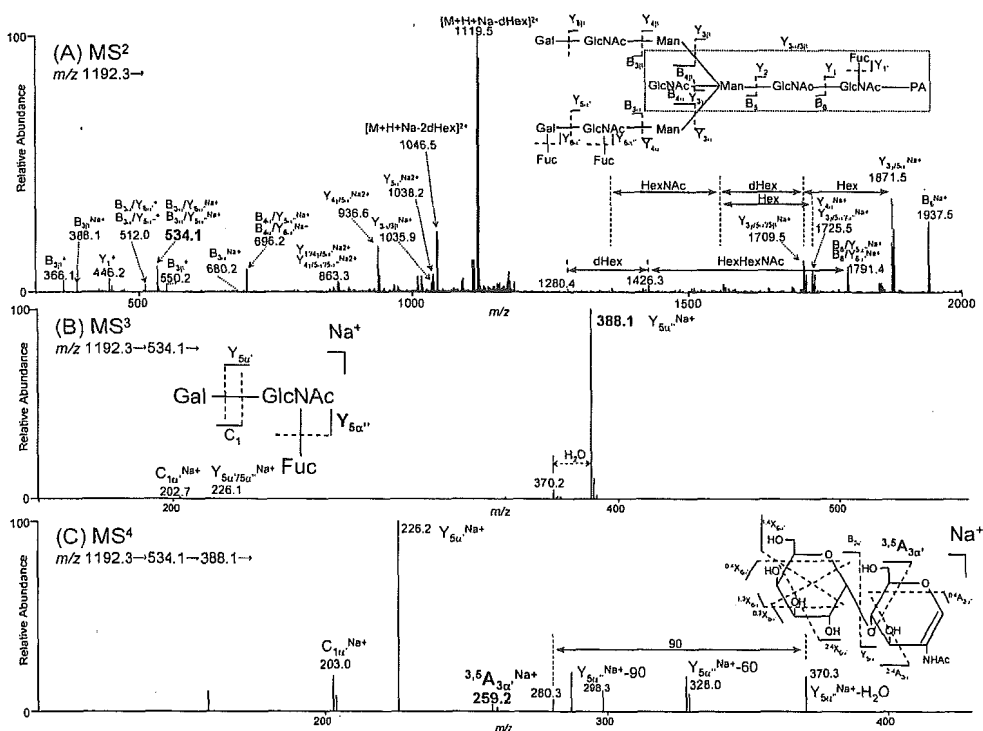

**Figure 8.** MS<sup>2-4</sup> spectra of oligosaccharide *f* by LC/ESI-MS<sup>n</sup>: (A) MS<sup>2</sup> spectrum of [M+H+Na]<sup>2+</sup> at *m/z* 1192.3; (B) MS<sup>3</sup> spectrum of [dHexHexNAC+Na]<sup>+</sup> at *m/z* 534.1 detected in MS<sup>2</sup>; and (C) MS<sup>4</sup> spectrum of [HexHexNAC+Na]<sup>+</sup> at *m/z* 388.1 detected in MS<sup>3</sup>.

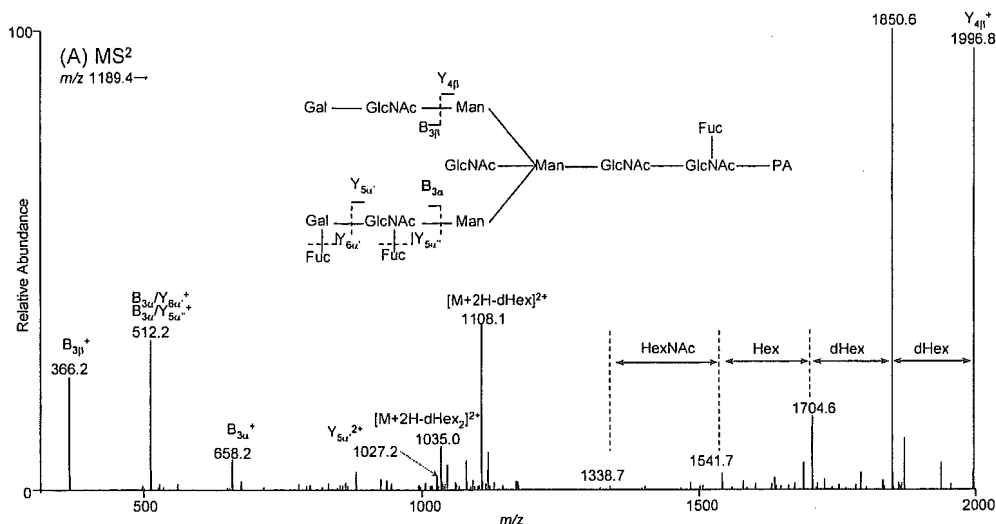

Figure 9. MS<sup>2</sup> spectrum of oligosaccharide f by LC/ESI-MS<sup>n</sup>; precursor ion, [M+H+NH<sub>4</sub>]<sup>2+</sup> at m/z 1189.9.

Le<sup>x</sup>-oligosaccharides in biological samples. Our method, based on a sequential scan for the structure-characteristic ions, may be applicable to the analyses of oligosaccharides carrying other partial motifs, such as sialyl Le<sup>x</sup> and sulfated sugar.

### Acknowledgements

This study was supported in part by Grant-in-Aid from the Ministry of Health Labor and Welfare, and Core Research for the Evolutional Science and Technology Program, Japan Science and Technology Corp.

### REFERENCES

1. Feizi T. *Nature* 1985; **314**: 53.
2. Walz G, Aruffo A, Kolanus W, Bevilacqua M, Seed B. *Science* 1990; **250**: 1132.
3. Kannagi R, Izawa M, Koike T, Miyazaki K, Kimura N. *Cancer Sci.* 2004; **95**: 377.
4. Coombs PJ, Graham SA, Drickamer K, Taylor ME. *J. Biol. Chem.* 2005; **280**: 22993.
5. Larkin M, Ahern TJ, Stoll MS, et al. *J. Biol. Chem.* 1992; **267**: 13661.
6. Lowe JB, Stoolman LM, Nair RP, Larsen RD, Berhend TL, Marks RM. *Cell* 1990; **63**: 475.
7. Phillips ML, Nudelman E, Gaeta FC, Perez M, Singhal AK, Hakomori S, Paulson JC. *Science* 1990; **250**: 1130.
8. Sagi D, Peter-Katalinic J, Conradt HS, Nimtz M. *J. Am. Soc. Mass Spectrom.* 2002; **13**: 1138.
9. Sheeley DM, Reinhold VN. *Anal. Chem.* 1998; **70**: 3053.
10. Xue J, Song L, Khaja SD, Locke RD, West CM, Laine RA, Matta KL. *Rapid Commun. Mass Spectrom.* 2004; **18**: 1947.
11. Karlsson NG, Schulz BL, Packer NH. *J. Am. Soc. Mass Spectrom.* 2004; **15**: 659.
12. Karlsson NG, Wilson NL, Wirth HJ, Dawes P, Joshi H, Packer NH. *Rapid Commun. Mass Spectrom.* 2004; **18**: 2282.
13. Zhang S, Chelius D. *J. Biomol. Technol.* 2004; **15**: 120.
14. Royle L, Mattu TS, Hart E, Langridge JI, Merry AH, Murphy N, Harvey DJ, Dwek RA, Rudd PM. *Anal. Biochem.* 2002; **304**: 70.
15. Takegawa Y, Deguchi K, Ito S, Yoshioka S, Nakagawa H, Nishimura S. *Rapid Commun. Mass Spectrom.* 2005; **19**: 937.
16. Takegawa Y, Ito S, Yoshioka S, Deguchi K, Nakagawa H, Monde K, Nishimura S. *Rapid Commun. Mass Spectrom.* 2004; **18**: 385.
17. Mechref Y, Novotny MV, Krishnan C. *Anal. Chem.* 2003; **75**: 4895.
18. Weiskopf AS, Vouros P, Harvey DJ. *Anal. Chem.* 1998; **70**: 4441.
19. Meisen I, Peter-Katalinic J, Muthing J. *Anal. Chem.* 2003; **75**: 5719.
20. Chui D, Sellakumar G, Green R, Sutton-Smith M, McQuistan T, Marek K, Morris H, Dell A, Marth J. *Proc. Natl. Acad. Sci. USA* 2001; **98**: 1142.
21. Yuan J, Hashii N, Kawasaki N, Itoh S, Kawanishi T, Hayakawa T. *J. Chromatogr. A* 2005; **1067**: 145.
22. Song F, Cui M, Liu Z, Yu B, Liu S. *Rapid Commun. Mass Spectrom.* 2004; **18**: 2241.
23. Cui M, Song F, Liu Z, Liu S. *Rapid Commun. Mass Spectrom.* 2001; **15**: 586.
24. Vakhrushev SY, Zamfir A, Peter-Katalinic J. *J. Am. Soc. Mass Spectrom.* 2004; **15**: 1863.
25. Suzuki S, Kakehi K, Honda S. *Anal. Chem.* 1996; **68**: 2073.
26. Yoshino K, Takao T, Murata H, Shimonishi Y. *Anal. Chem.* 1995; **67**: 4028.
27. Tomiya N, Aways J, Kurono M, Endo S, Arata Y, Takahashi N. *Anal. Biochem.* 1988; **171**: 73.



# Characterization of a gel-separated unknown glycoprotein by liquid chromatography/multistage tandem mass spectrometry Analysis of rat brain Thy-1 separated by sodium dodecyl sulfate-polyacrylamide gel electrophoresis

Satsuki Itoh<sup>a</sup>, Nana Kawasaki<sup>a,b,\*</sup>, Akira Harazono<sup>a</sup>, Noritaka Hashii<sup>a</sup>,  
Yukari Matsuishi<sup>b</sup>, Toru Kawanishi<sup>a</sup>, Takao Hayakawa<sup>a</sup>

<sup>a</sup> Division of Biological Chemistry and Biologicals, National Institute of Health Science, 1-18-1, Kamiyoga, Setagaya-ku, Tokyo 158-8501, Japan

<sup>b</sup> CREST, Japan Science and Technology Agency (JST), Japan

Received 17 May 2005; received in revised form 17 July 2005; accepted 25 July 2005  
Available online 5 October 2005

## Abstract

We developed an efficient and convenient strategy for protein identification and glycosylation analysis of a small amount of unknown glycoprotein in a biological sample. The procedure involves isolation of proteins by electrophoresis and mass spectrometric peptide/glycopeptide mapping by LC/ion trap mass spectrometer. For the complete glycosylation analysis, proteins were extracted in intact form from the gel, and proteinase-digested glycoproteins were then subjected to LC/multistage tandem MS (MS<sup>n</sup>) incorporating a full mass scan, in-source collision-induced dissociation (CID), and data-dependent MS<sup>n</sup>. The glycopeptides were localized in the peptide/glycopeptide map by using oxonium ions such as HexNAc<sup>+</sup> and NeuAc<sup>+</sup>, generated by in-source CID, and neutral loss by CID-MS/MS. We conducted the search analysis for the glycopeptide identification using search parameters containing a possible glycosylation at the Asn residue with *N*-acetylglucosamine (203 Da). We were able to identify the glycopeptides resulting from predictable digestion with proteinase. The glycopeptides caused by irregular cleavages were not identified by the database search analysis, but their elution positions were localized using oxonium ions produced by in-source CID, and neutral loss by the data-dependent MS<sup>n</sup>. Then, all glycopeptides could be identified based on the product ion spectra which were sorted from data-dependent CID-MS<sup>n</sup> spectra acquired around localized positions. Using this strategy, we successfully elucidated site-specific glycosylation of Thy-1, glycosylphosphatidylinositol (GPI)-anchored proteins glycosylated at Asn23, 74, and 98, and at Cys111. High-mannose-type, complex-type, and hybrid-type oligosaccharides were all found to be attached to Asn23, 74 and 98, and four GPI structures could be characterized. Our method is simple, rapid and useful for the characterization of unknown glycoproteins in a complex mixture of proteins.  
© 2005 Elsevier B.V. All rights reserved.

**Keywords:** Glycoprotein; LC/MS; Ion trap mass spectrometer; In-source CID; Thy-1

## 1. Introduction

Glycosylation is one of the most abundant post-translational modifications of proteins [1]. Most glycoproteins exist in heterogeneous forms due to their carbohydrate heterogeneity at multiple glycosylation sites. Because heterogeneity at each glycosylation site can be associated with

many biological functions [2,3], it is necessary to analyze the oligosaccharide structures at each glycosylation site.

Mass spectrometric peptide/glycopeptide mapping by liquid chromatography coupled with electrospray ionization tandem mass spectrometry (LC/ESI-MS/MS) is now used for characterization of glycoproteins [4,5]. Site-specific glycosylation of some gel-separated glycoproteins can be analyzed by in-gel proteinase digestion followed by MS; this method, however, gives unsatisfactory results due to a lower recovery of some glycopeptides from the gel [6–8]. For

\* Corresponding author. Tel.: +81 3 3700 1141; fax: +81 3 3707 6950.  
E-mail address: [nana@nihs.go.jp](mailto:nana@nihs.go.jp) (N. Kawasaki).



complete site-specific glycosylation analysis, all glycopeptide fragments should be recovered from the gel. Hence, the extraction of a whole glycoprotein from the gel before proteinase digestion would be more reasonable than in-gel digestion. Additionally, the poor ionization efficiency of glycopeptides makes it difficult to analyze the glycosylation of glycopeptides in a complex mixture of peptides [6,9]. The glycopeptide-specific method is required for mass spectrometric peptide/glycopeptide mapping.

A precursor ion scan using triple quadrupole-type mass spectrometer is favorably used for analysis of glycopeptides [10–13]. However, this method requires repetitive analysis for the protein identification and glycosylation analysis, as it monitors carbohydrate marker ions such as HexNAc<sup>+</sup> and Hex-HexNAc<sup>+</sup> fragmented from glycopeptides by collision-induced dissociation (CID)-MS/MS, and does not provide product ion spectra of non-glycosylated peptides. As such, additional analysis would not be possible for small quantities of proteins, including gel-separated glycoproteins. As an alternative method, we have previously demonstrated peptide/glycopeptide mapping using quadrupole time-of-flight mass spectrometer, by which product ions arise from both peptides and carbohydrates [14]. Using oxonium ions as marker ions, we can sort out product ion spectra of glycopeptides from a number of product ion spectra of peptides, and can determine the amino acid sequences of glycopeptides, glycosylation sites, and monosaccharide composition in a single analysis. Recently, ion trap mass spectrometry (ITMS), which is capable of data-dependent multistage tandem MS (MS<sup>n</sup>), has been found to be preferable for use in glycosylation analysis of glycopeptides [15,16]. Glycopeptide-specific detection by precursor ion scan and data-dependent scan cannot be used for glycosylation analysis by ITMS due to the low mass cut-off system. Instead, oxonium ions fragmented by in-source CID are used for the localization of glycopeptides in the peptide/glycopeptide map [3,17]. It has recently been reported that peptide + GlcNAc ions originating from *N*-glycosylated peptides by MS<sup>2</sup> yield peptide b and y ions by further MS<sup>n</sup>, and that the peptide sequence and *N*-glycosylation sites can be identified based on the peptide fragment ions [15,16,18]. In addition, another group has reported that glycopeptides can be identified in peptide/glycopeptide map by a search analysis using a database to which all possible cleavage products of the glycopeptides have been added in advance [19]. A combination of peptide/glycopeptide mapping with in-source CID, data-dependent CID-MS<sup>n</sup>, and the database search analysis would enable protein identification, glycopeptide selection, and glycosylation analysis of a small amount of glycoprotein.

In the present study, we developed a strategy for the characterization of a small amount of unknown glycoprotein in a biological sample. An unknown glycoprotein was isolated by electrophoresis and extracted from the gel in an intact form. We used sodium dodecyl sulfate (SDS), which is effective for extracting proteins from the gel, and could be easily removed by adding cold acetone. The proteinase-

digested glycoprotein was subjected to peptide/glycopeptide mapping, with the sequential scan consisting of a full mass scan, in-source CID, and data-dependent CID-MS<sup>n</sup>. Using this method, we carried out site-specific glycosylation analysis of glycosylphosphatidylinositol (GPI)-anchored proteins in rat brain. A computer database search was used for the identification of a GPI-anchored protein and its *N*-glycosylation sites. In-source CID and data-dependent CID-MS/MS were also used for localization of peptides with *N*-glycan and GPI in the peptide/glycopeptide map. On the basis of their product ion spectra, we elucidated *N*-glycosylation at each glycosylation site and the structure of GPIs.

## 2. Experimental

### 2.1. Materials

Rat brains were purchased from Nippon SLC (Hamamatsu, Japan). Trypsin-Gold and endoproteinase Asp-N were purchased from Promega (Madison, WI, USA) and Wako Pure Chemical (Osaka, Japan), respectively. Phosphatidylinositol-specific phospholipase C (PIPLC) from *Bacillus cereus* were purchased from Molecular Probes (Eugene, OR, USA). All other chemicals used were of the highest purity available.

### 2.2. Sodium dodecyl sulfate-polyacrylamide gel electrophoresis (SDS-PAGE) of PIPLC-treated GPI-anchored proteins

PIPLC-treated GPI-anchored proteins were prepared from rat brain utilizing Triton X-114 phase partition and PIPLC digestion [20,21]. Two whole rat brains (2.8 g, Wistar, male, 3 weeks) were homogenized in cold acetone and centrifuged for 10 min at 4 °C. The precipitate was then homogenized in CHCl<sub>3</sub>:methanol (2:1, v/v) and centrifuged for 10 min at 4 °C. After being washed with methanol, the pellet was homogenized in 50 mM Tris-HCl (pH 7.4) containing 150 mM NaCl, 1 mM ethylenediaminetetraacetic acid (EDTA), and 1 mM phenylmethylsulfonyl fluoride (PMSF), and centrifuged at 10,000 × *g* at 4 °C for 20 min. The pellet was resuspended in the same buffer with an additional 2% Triton X-114 (v/v), and stirred at 4 °C for 16 h. After centrifugation at 10,000 × *g* at 4 °C for 20 min, the supernatant was subjected to Triton X-114 phase-partitioning at 37 °C for 10 min. The detergent phase was resuspended with an equal volume of 50 mM Tris-HCl (pH 7.4) containing 150 mM NaCl. Solubilized membrane proteins in the detergent phase were precipitated with cold acetone and were resuspended in 400 μl of 50 mM Tris-HCl (pH 7.4). Following the addition of PIPLC (1 U), the suspension was incubated at 37 °C for 18 h. The suspension was resubjected to Triton X-114 phase-partitioning, and PIPLC-treated GPI-anchored proteins were precipitated with cold acetone from the aqueous phase. PIPLC-treated GPI-anchored proteins obtained from

50 mg of rat brain were separated by SDS-PAGE (12.5%) after carboxyamidomethylation [22].

### 2.3. Extraction and digestion of gel-separated proteins

The protein in gel band was extracted with 20 mM Tris-HCl containing 1% SDS by shaking vigorously overnight after breaking down the gel into small bits. The extract was filtered with Ultrafree-MC (0.22  $\mu$ m, Millipore, Bedford, USA), and the protein was precipitated by adding cold acetone. The precipitate was digested with trypsin (1  $\mu$ g) in 20  $\mu$ l of 0.1 M Tris-HCl (pH 8.0) at 37 °C for 16 h, or with Asp-N (0.4  $\mu$ g) in 20  $\mu$ l of 5 mM Tris-HCl (pH 7.5) at 37 °C overnight.

### 2.4. LC/MS<sup>n</sup>

Proteolytic peptides were separated by a Magic C18 column (50 mm  $\times$  0.2 mm, 3  $\mu$ m, Michrom BioResources, Auburn, CA, USA) with a Paradaim MS4 HPLC system (Michrom BioResources Inc., Auburn, CA, USA) consisting of pump A: 0.1% formic acid and 2% acetonitrile, and pump B: 0.1% formic acid and 90% acetonitrile. Separation was performed with a linear gradient of 5–65% of pump B in 40 min after 5% in 10 min of pump B at a flow rate 3  $\mu$ l/min. Mass spectra were recorded by Finnigan LTQ (Thermo Electron, San Jose, CA, USA) with the sequential scan: a full mass scan ( $m/z$  300–2000), a full mass scan with in-source CID ( $m/z$  80–500, collision energy: 50 V), and data-dependent CID-MS<sup>n</sup> for most intense ions at each scan with dynamic exclusion for 30 s. Scan time ( $m/z$  300–2000) is approximately 0.1 s. The operating condition used for LC/ITMS was as follows: tube lens offset of 130 V, capillary voltage of 2.0 kV, capillary temperature of 200 °C.

### 2.5. Computer database search analysis

All product ions obtained by LC/ITMS were subjected to the computer database search analysis with the TurboSEQUEST search engine (Thermo Electron, San Jose, CA, USA). We used the NCBI database (rat, updated at February 2003) and following search parameters: a static modification of carboxyamidomethylation (57 Da) at Cys, a possible modification of GlcNAc (203 Da) at Asn, and trypsin used for digestion.

## 3. Results

### 3.1. Extraction of whole proteins from the gel

Rat brain PIPLC-treated GPI-anchored proteins were separated by SDS-PAGE (Fig. 1), and the most noticeable band at 20–25 kDa was cut off from the gel and crushed. The gel pieces were shaken vigorously in 1% SDS, and the extracted protein was precipitated with cold acetone to remove SDS.

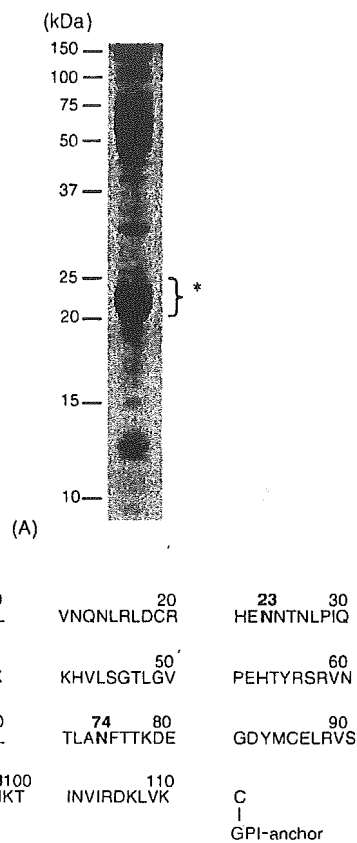

Fig. 1. (A) SDS-PAGE of PIPLC-treated GPI-anchored proteins from rat brain. (B) Amino acid sequence of rat Thy-1. *N*-Glycosylation sites are indicated by bold face. The protein at 20–25 kDa indicated by asterisk was subjected to the glycosylation analysis in this study.

We checked the recovery of the protein at 20–25 kDa by comparing the fluorescence intensity (Ex 633 nm/Em 670 nm) of the proteins at 20–25 kDa visualized by Coomassie staining before and after extraction. Approximately 55% of the protein at 20–25 kDa could be recovered from the gel (data not shown). The protein was digested with trypsin and subjected to the sequential scan consisting of full mass scans with and without in-source CID and data-dependent MS<sup>n</sup> by LC/ITMS for protein identification and glycosylation analysis.

### 3.2. Database search analysis

Fig. 2(A) shows the peptide/glycopeptide map of the trypsin-digested protein at 20–25 kDa. First, all product ions generated by data-dependent MS<sup>n</sup> were used for the database search analysis. Using search parameters described in Section 2.5, the protein was identified as Thy-1, a glycoprotein containing three *N*-glycosylation sites at Asn23, 74, and 98, and a GPI attachment site at Cys111. The search analysis also suggested the glycosylation at Asn74 and 98, with elution positions of 34 min (peak T6, Val69-Lys78) and 3.5 min (peak T1, Val89-Lys99), respectively (Fig. 2(A)). Although

Table 1  
Glycosylation analysis of rat brain Thy-1

Glycosylation site	Carbohydrate composition <sup>a</sup>				Theoretical carbohydrate mass <sup>b</sup>	Trypsin			Asp-N								
	dHex	Hex	HexNAc	NeuAc		Observed m/z	Charge state	Peak number	Amino acid residue <sup>c</sup>	Theoretical m/z <sup>b</sup>	Observed m/z	Charge state	Peak number	Amino acid residue <sup>c</sup>	Theoretical m/z <sup>b</sup>		
Asn23	0	5	2	0	1234.43	845.33	3	T3	H21-H31 (1315.63)	845.03	799.47	3	A3	E22-H31 (1178.57)	799.34		
						937.27	3	T4	H21-F33 (1591.74)	937.06	1198.69	2	A3	E22-H31 (1178.57)	1198.50		
						1405.81	2	T4	H21-F33 (1591.74)	1405.09	949.60	3	A3	N23-T36 (1626.80)	948.75		
											1423.40	2	A3	N23-T36 (1626.80)	1422.62		
	0	6	2	0	1396.49	899.49	3	T3	H21-H31 (1315.63)	899.04	853.54	3	A3	E22-H31 (1178.57)	853.36		
						1348.35	2	T3	H21-H31 (1315.63)	1348.06	1279.66	2	A3	E22-H31 (1178.57)	1279.53		
						942.16	3	T3	H21-E32 (1444.67)	942.06	1211.52	2	A5	E22-Q30 (1041.51)	1211.00		
						991.37	3	T5	H21-F33 (1591.74)	991.08							
						1486.40	2	T5	H21-F33 (1591.74)	1486.12							
											1044.43	3	A3	N23-T36 (1626.80)	1043.79		
Asn74	0	7	2	0	1558.54	996.41	3	T3	H21-E32 (1444.67)	996.07	907.59	3	A3	E22-H31 (1626.80)	907.37		
											1361.03	2	A3	E22-H31 (1178.57)	1360.56		
	1	3	5	0	1665.62	1162.72	2	T6	V69-K78 (1106.62)	1162.53	1093.32	3	A3	N23-T36 (1626.80)	1092.48		
	1	5	4	0	1786.65	1043.45	2	T2	A73-K78 (680.35)	1042.94	1133.80	3	A3	N23-T36 (1626.80)	1132.82		
	0	6	3	1	1890.66	1063.68	2	T2	A73-K78 (680.35)	1063.45	1168.51	3	A4	N23-T36 (1626.80)	1167.49		
	1	6	4	0	1948.70	1276.61	2	T6	V69-K78 (1106.62)	1276.58	1187.21	3	A3	N23-T36 (1626.80)	1186.84		
						1124.18	2	T2	A73-K78 (680.35)	1123.96							
	1	5	3	0	1583.57	1337.64	2	T6	V69-K78 (1106.62)	1337.10							
	1	3	5	0	1665.62	1165.13	2	T2	A73-K78 (680.35)	1164.99	1272.15	2	A4	T71-K78 (894.48)	1272.05		
											1139.79	3	A7	D64-K78 (1766.01)	1138.88		
	2	5	3	0	1729.63	1378.19	2	T6	V69-K78 (1106.62)	1378.12							
	2	4	4	0	1770.66	1197.55	2	T2	A73-K78 (680.35)	1196.99							
						1217.67	2	T2	A73-K78 (680.35)	1217.51							
	1	5	4	0	1786.65	1430.71	2	T6	V69-K78 (1106.62)	1430.64							
						1226.38	2	T2	A73-K78 (680.35)	1225.50							
						960.01	3	T6	V69-K78 (1106.62)	959.43							
	1	4	5	0	1827.68	1439.05	2	T6	V69-K78 (1106.62)	1438.64							
	2	5	4	0	1932.71	973.79	3	T6	V69-K78 (1106.62)	973.10							
						1298.75	2	T2	A73-K78 (680.35)	1298.53							
	1	6	4	0	1948.70	1008.71	3	T6	V69-K78 (1106.62)	1008.11	1228.18	3	A7	D64-K78 (1766.01)	1227.91		
					1512.21	2	T6	V69-K78 (1106.62)	1511.67								
					1306.81	2	T2	A73-K78 (680.35)	1306.53								
					1013.98	3	T6	V69-K78 (1106.62)	1013.45								
0	4	5	1	1972.71	880.04	3	T2	A73-K78 (680.35)	879.70	1241.91	3	A7	D64-K78 (1766.01)	1241.25			
2	4	5	0	1973.73	1319.24	2	T2	A73-K78 (680.35)	1319.04	1241.84	3	A7	D64-K78 (1766.01)	1241.59			
					1022.43	3	T6	V69-K78 (1106.62)	1021.79								
					1532.49	2	T6	V69-K78 (1106.62)	1532.49								

