

APACHE 10~14

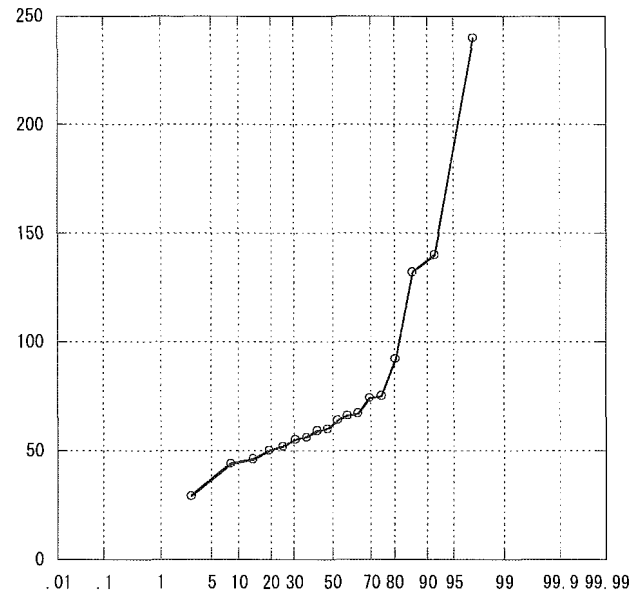

パーセント

APACHE 15~19

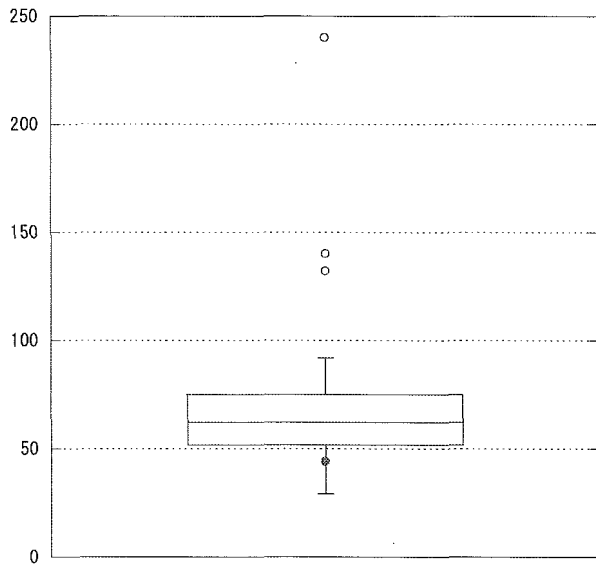
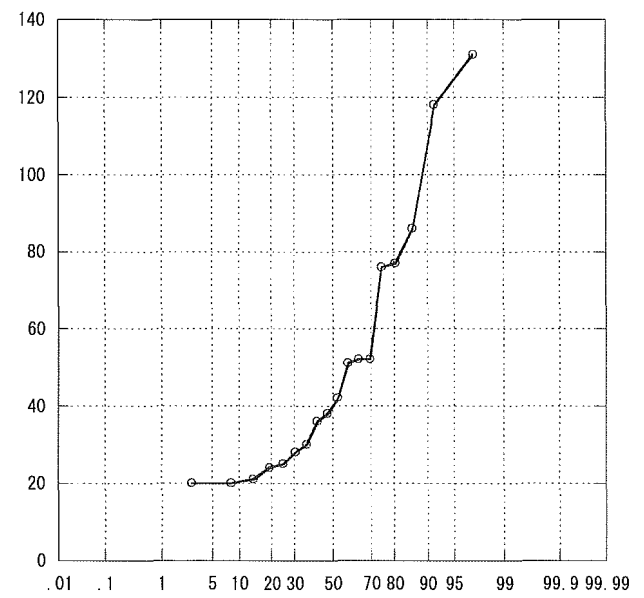
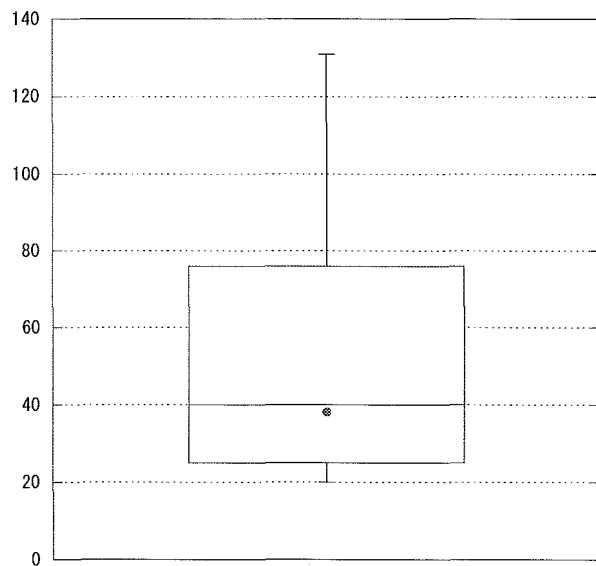

パーセント

APACHE 20~24

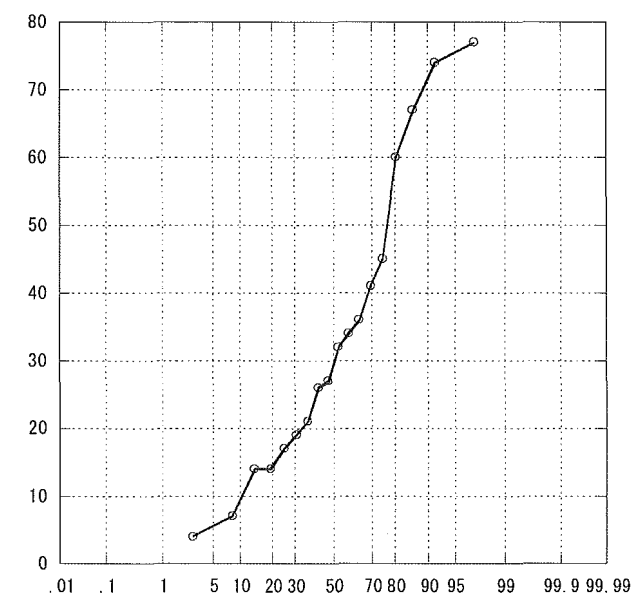
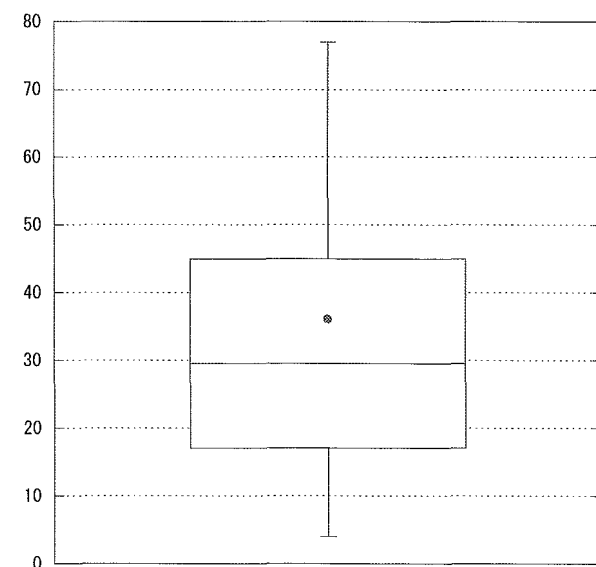

パーセント

APACHE 25~29

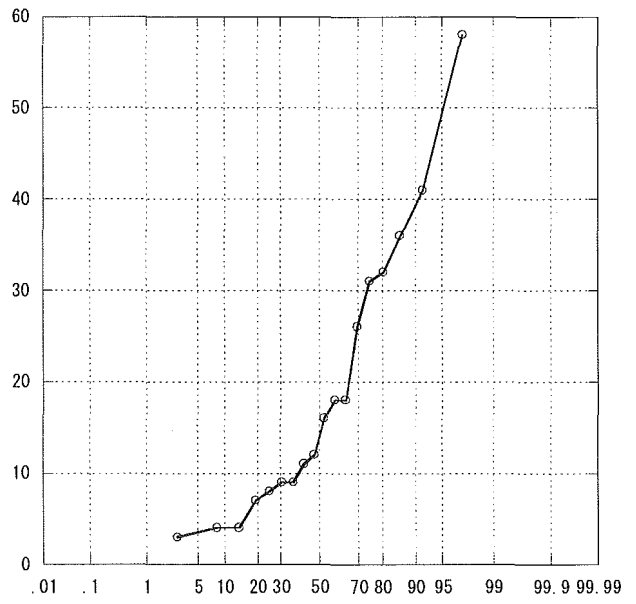
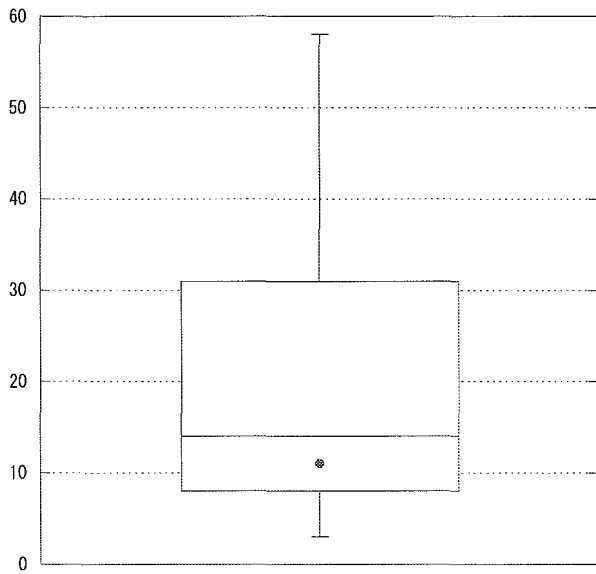

APACHE 30~34

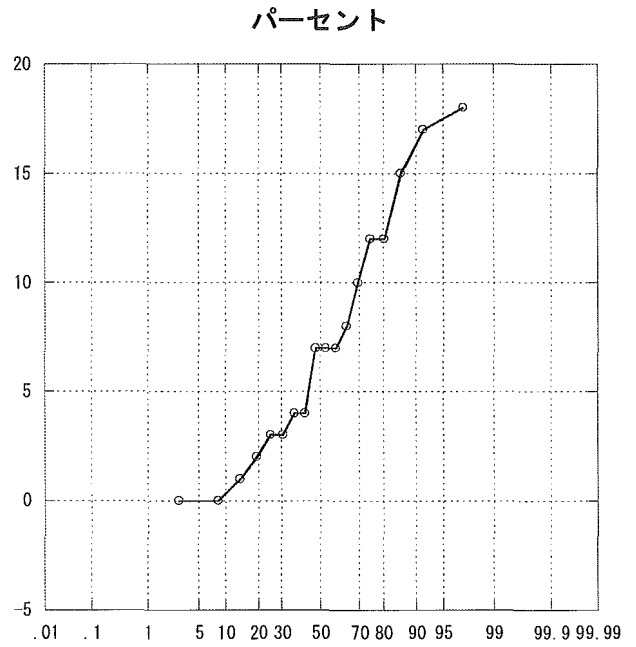
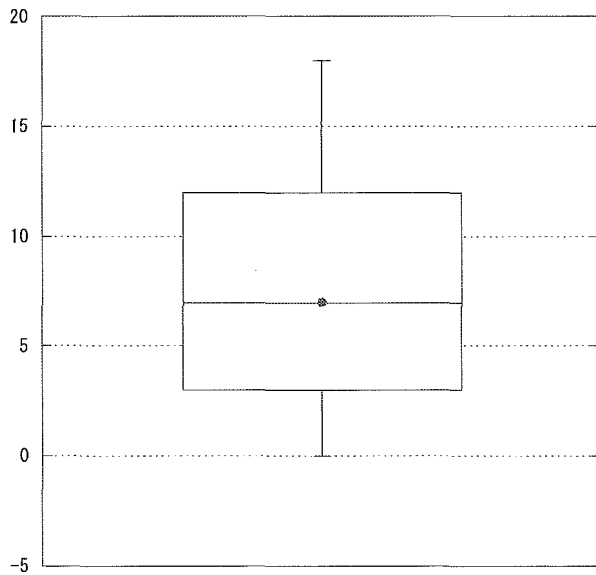

APACHE 35~

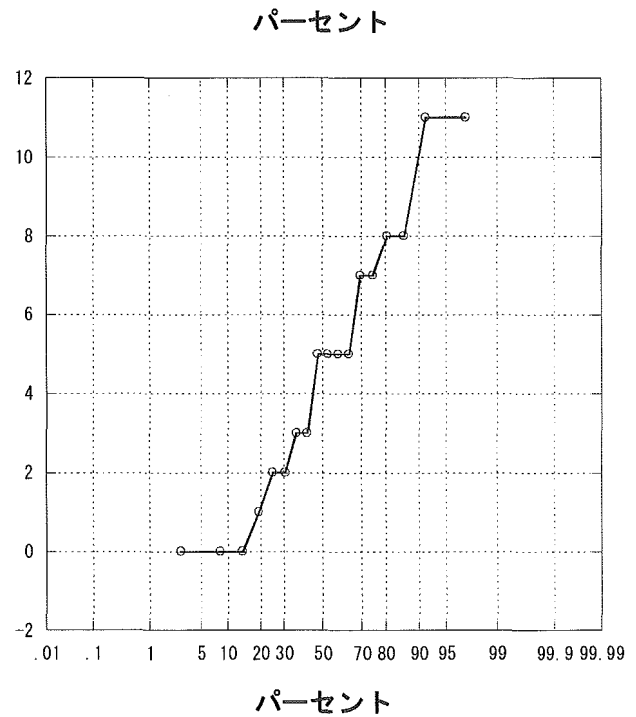
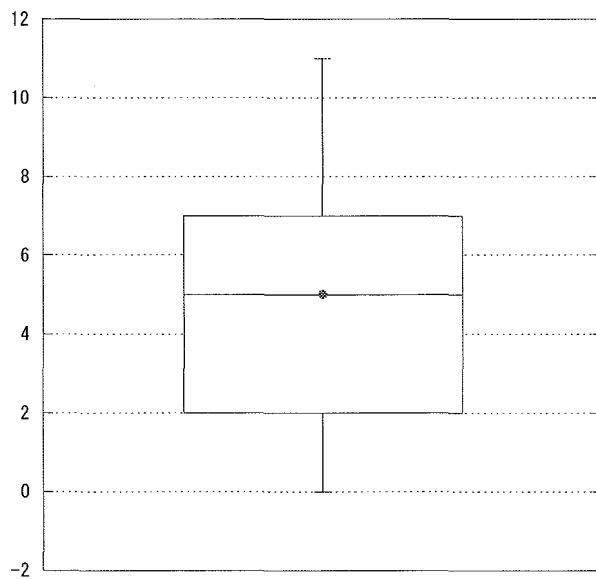

APACHE平均

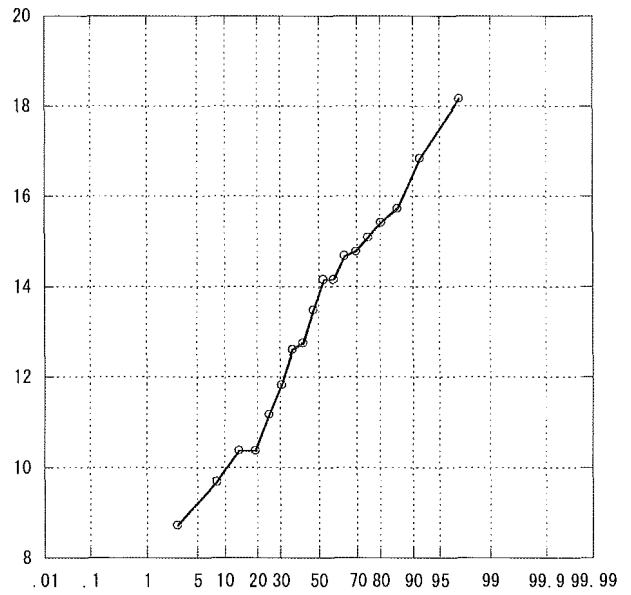
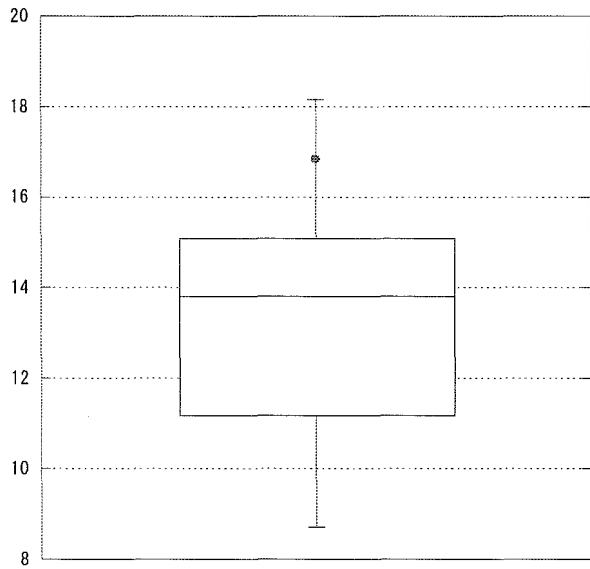

標準化死亡比

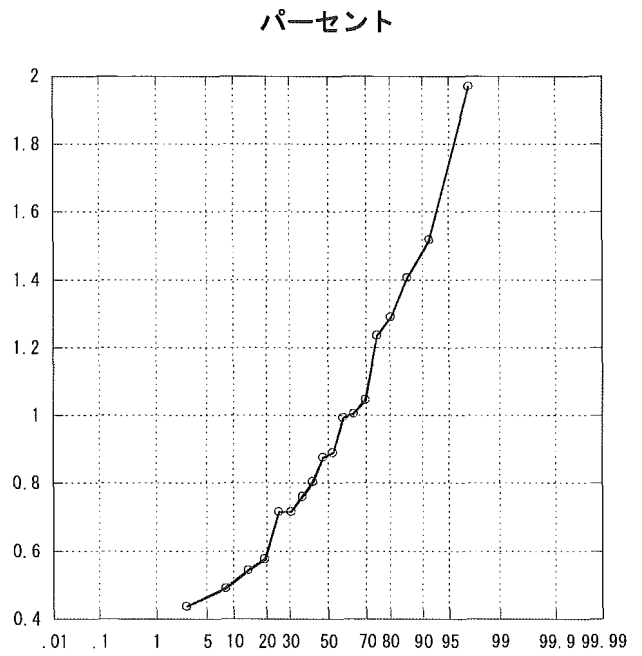
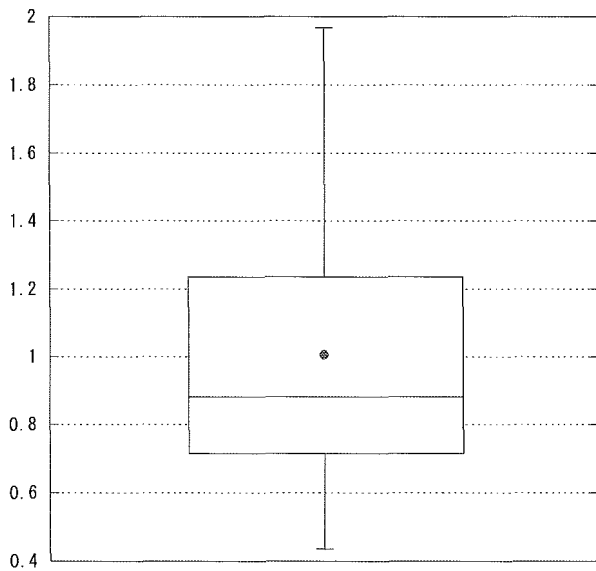

平均在室日数

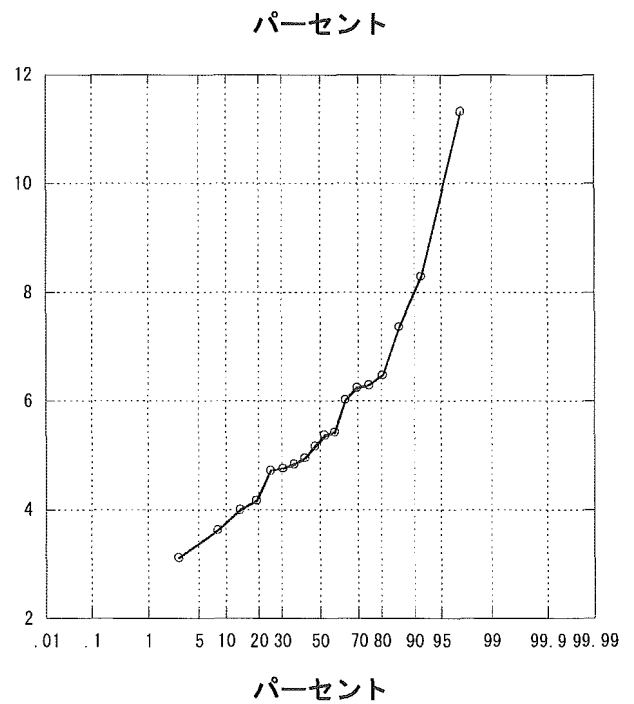
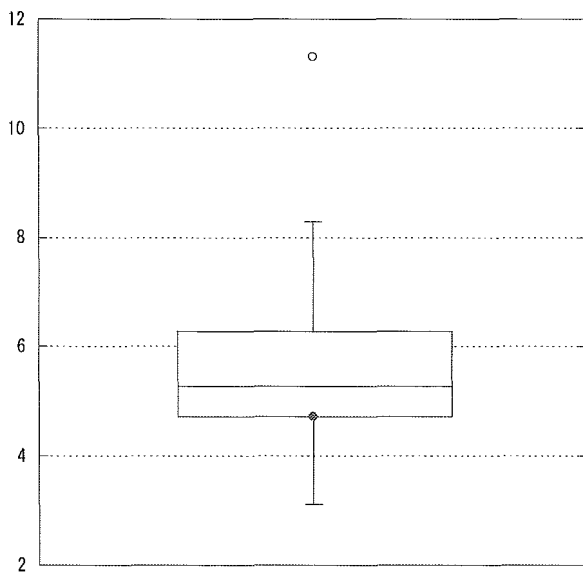

平均在院日数

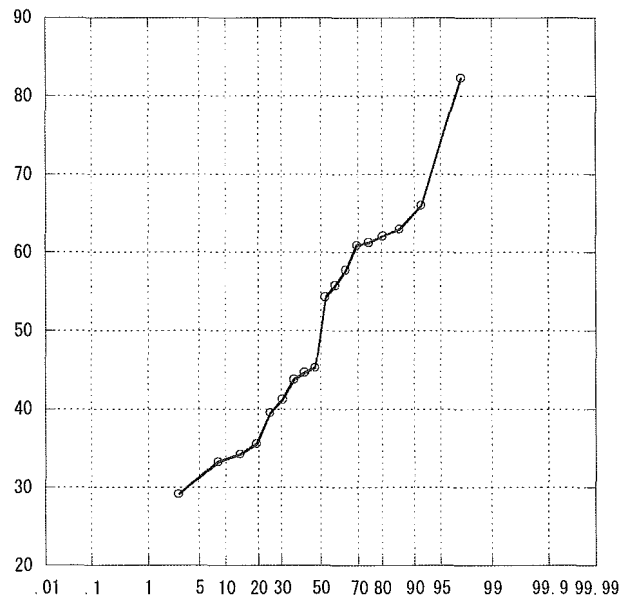
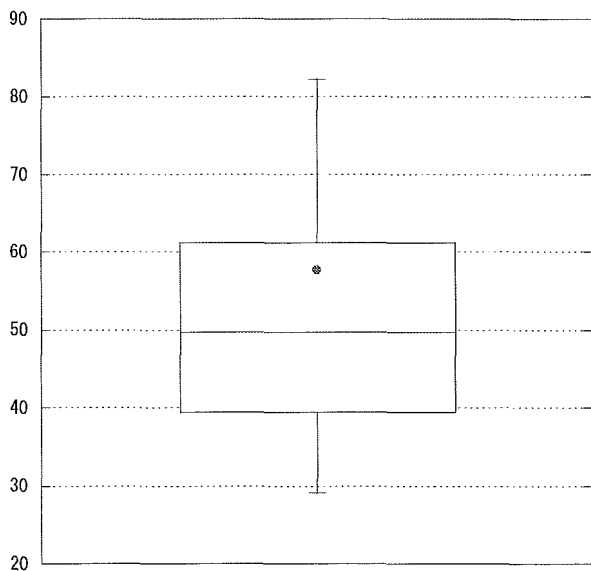

人工呼吸器利用率

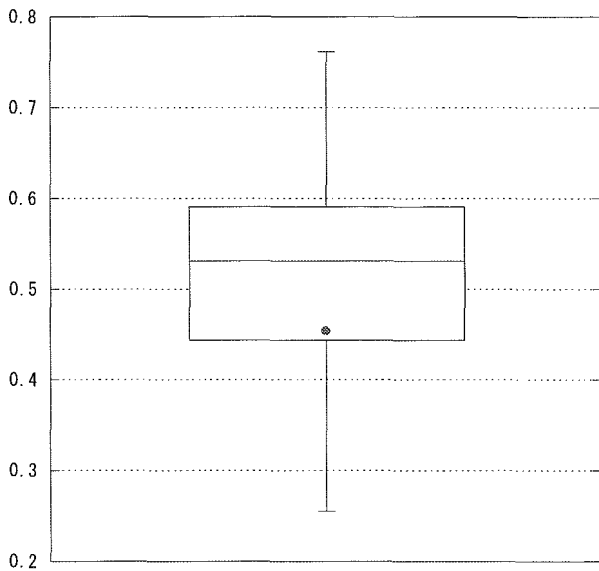

パーセント

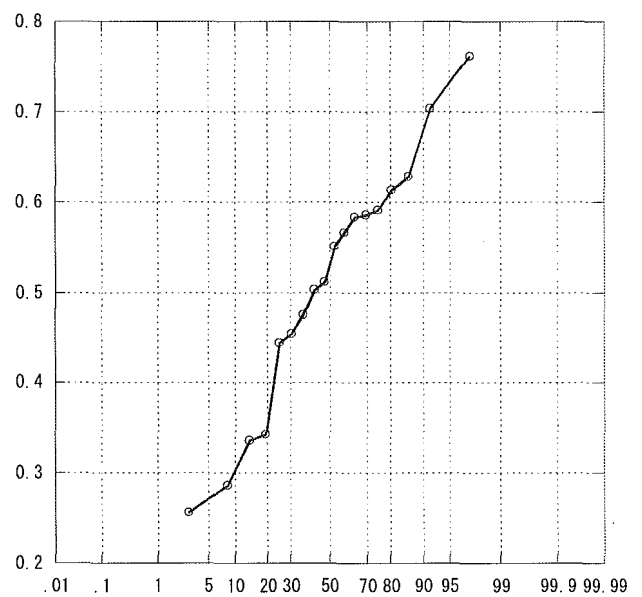

中心静脈カテ利用率

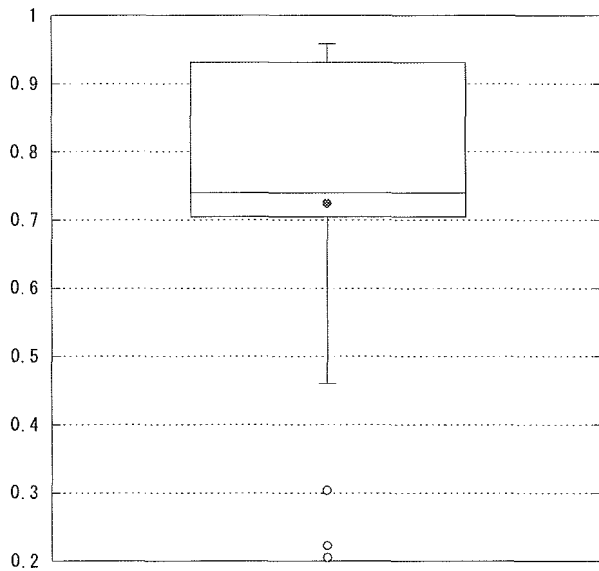

パーセント

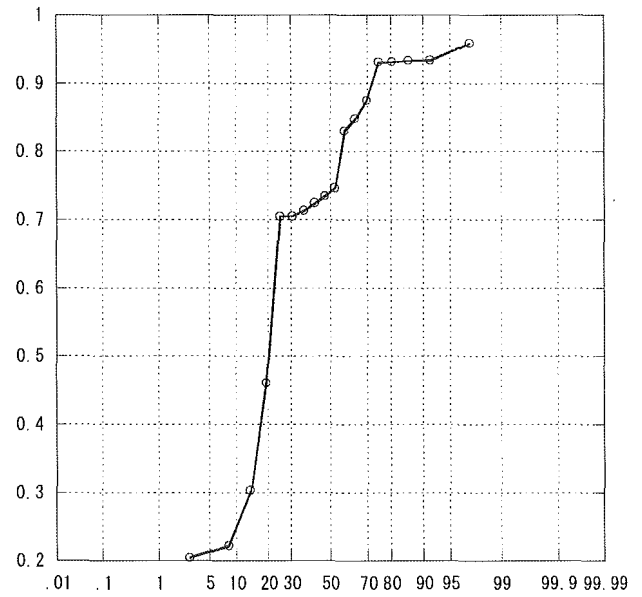

パーセント

尿道カテ利用率

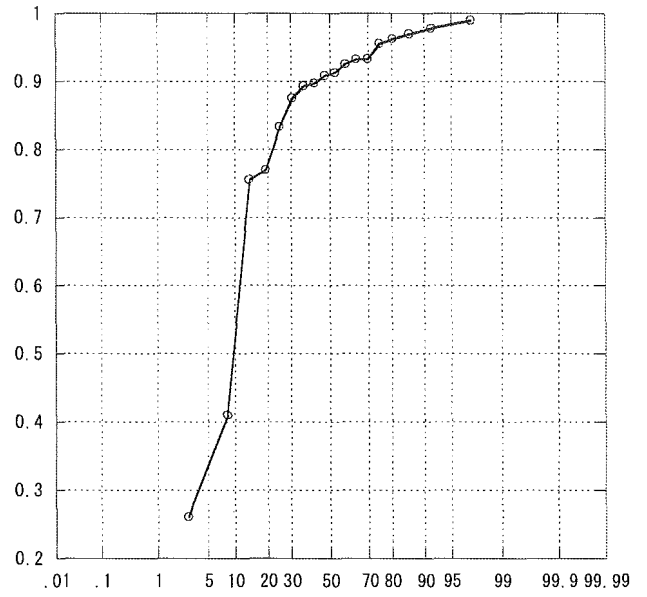
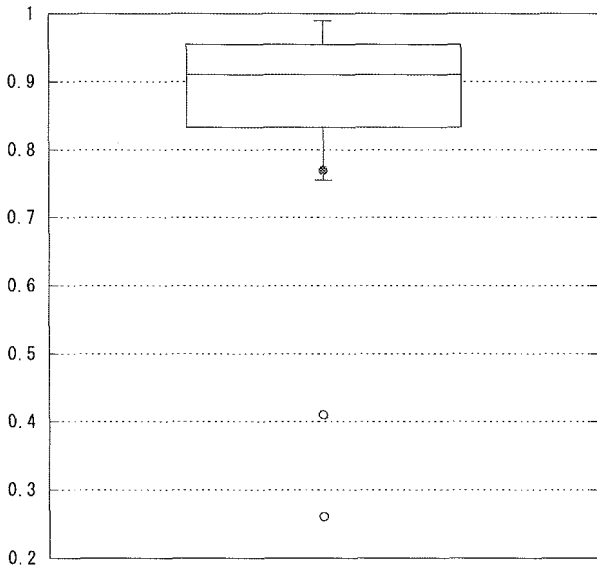

人工呼吸日／患者数

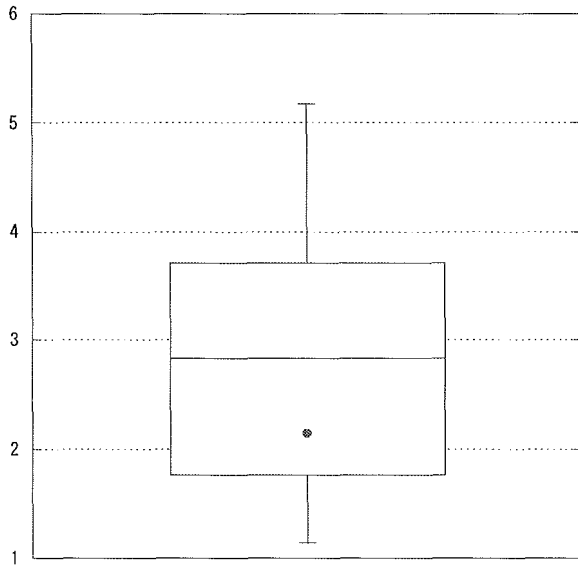

パーセント

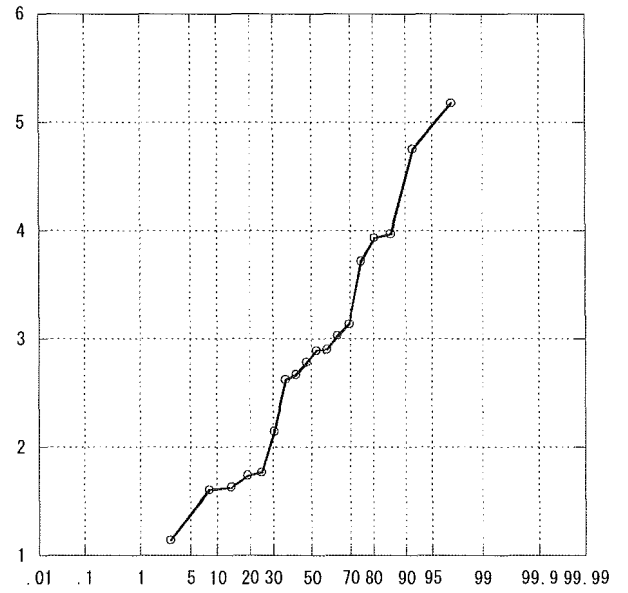

リスク調整感染率（肺炎）

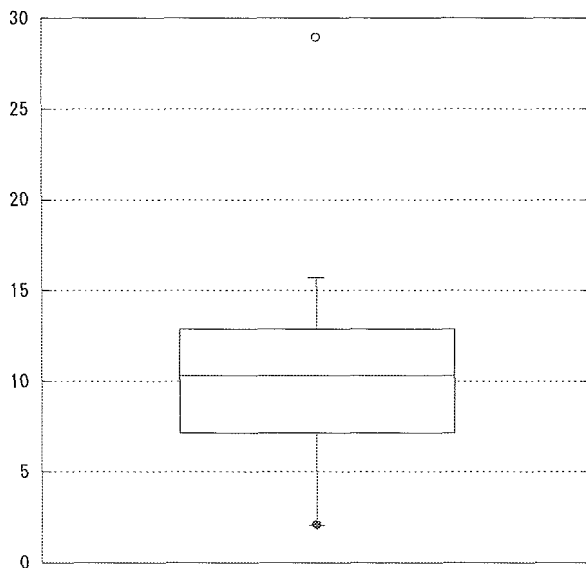

パーセント

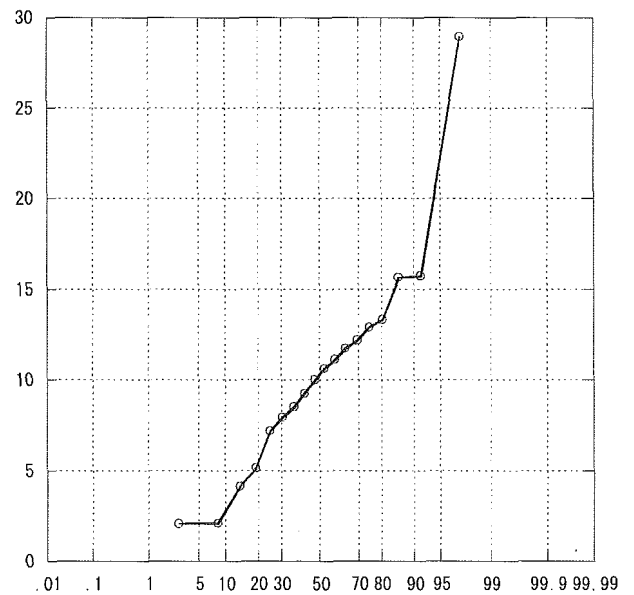

パーセント

リスク調整感染率 (カテ)

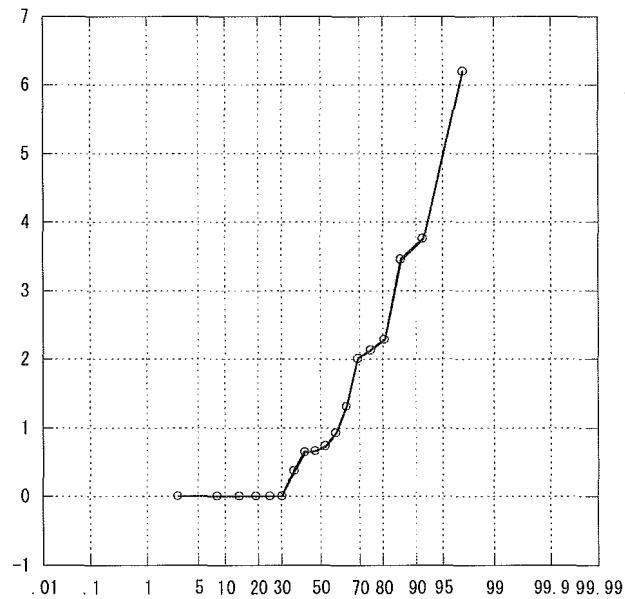
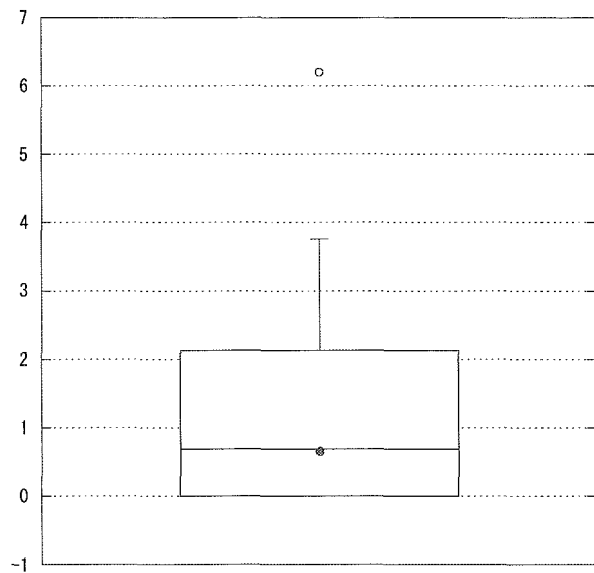

リスク調整感染率 (尿路)

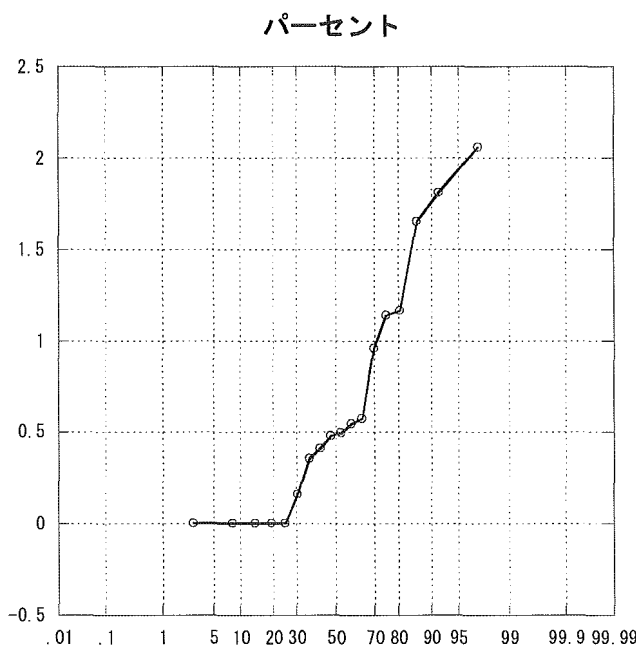
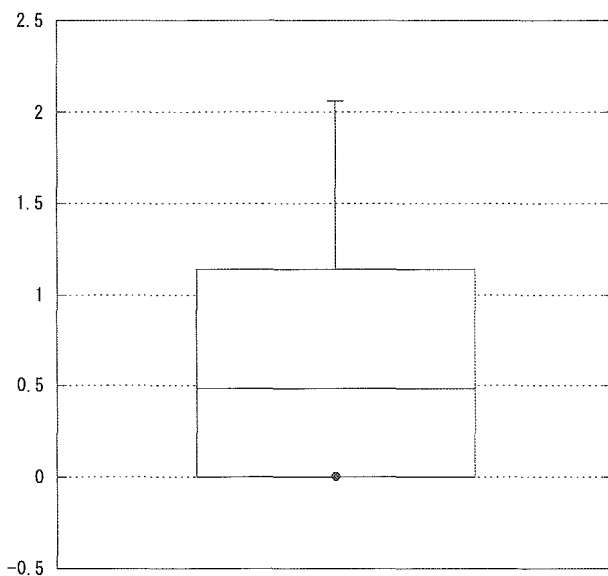

全感染率 (耐性)

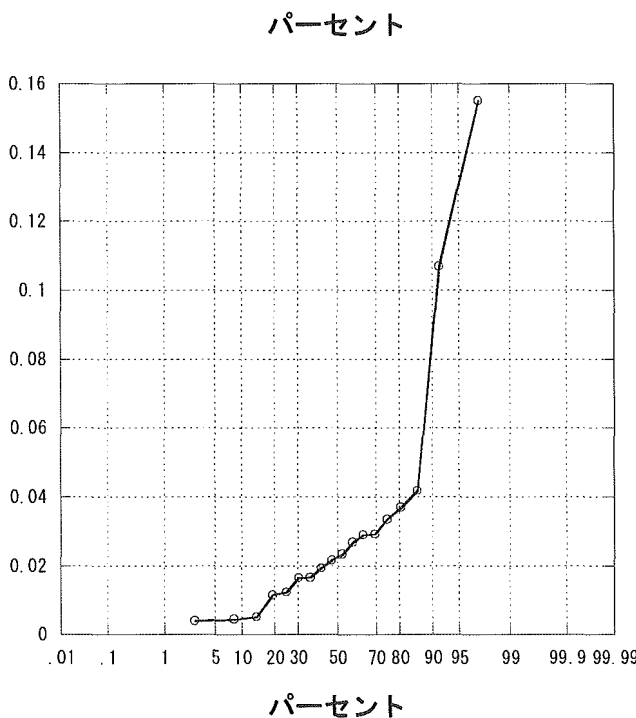
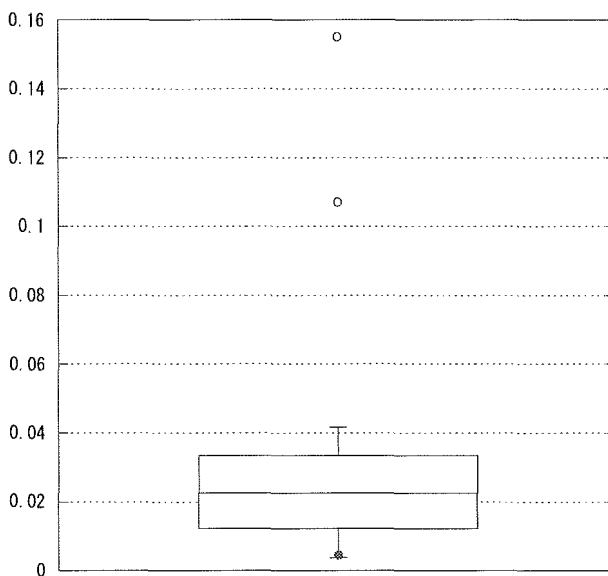

全感染率（感性）

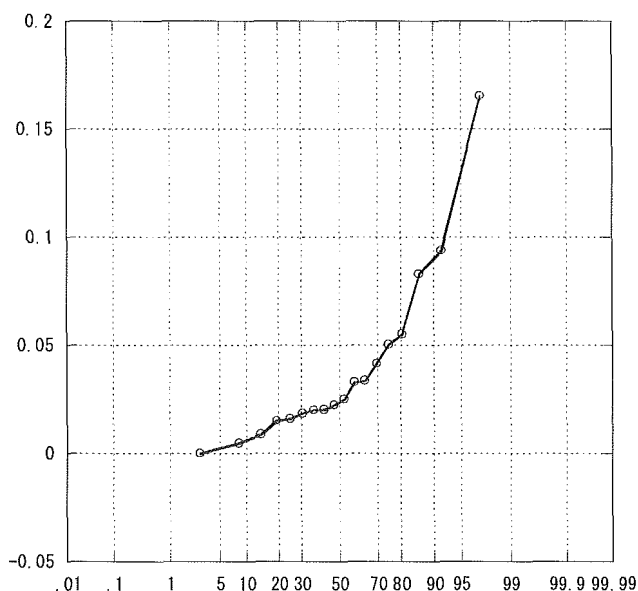
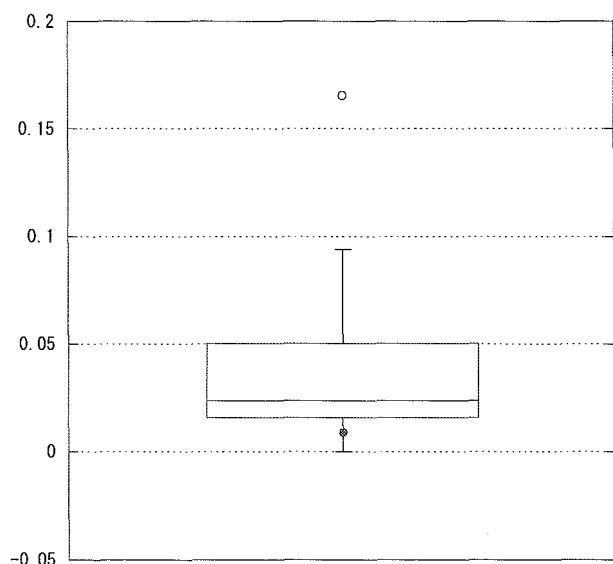

肺炎感染率（耐性）

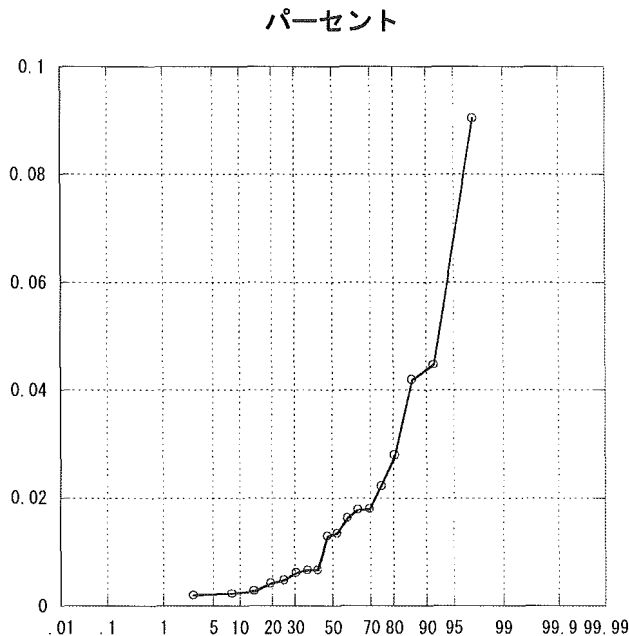
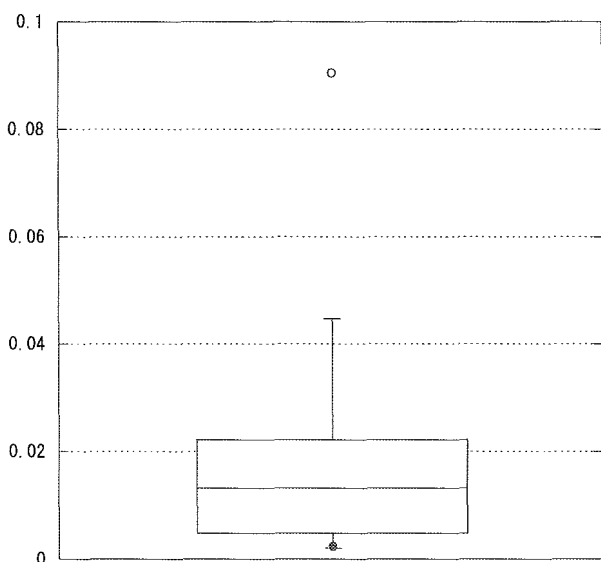

肺炎感染率（感性）

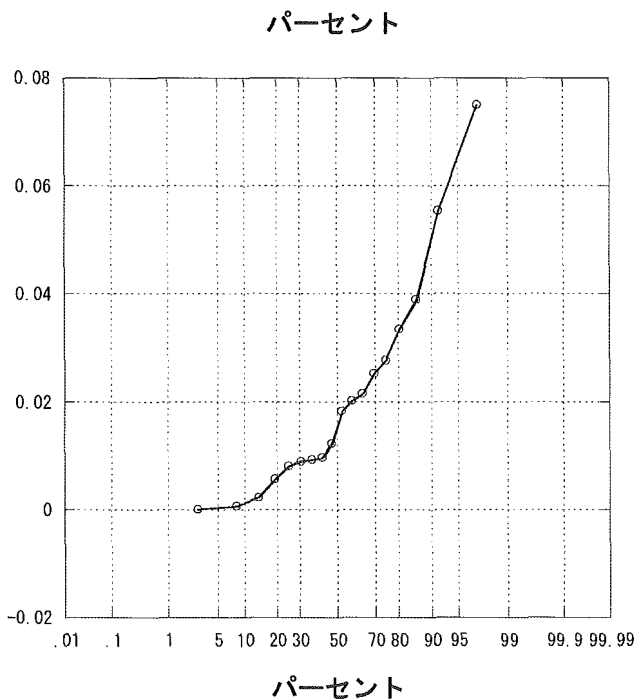
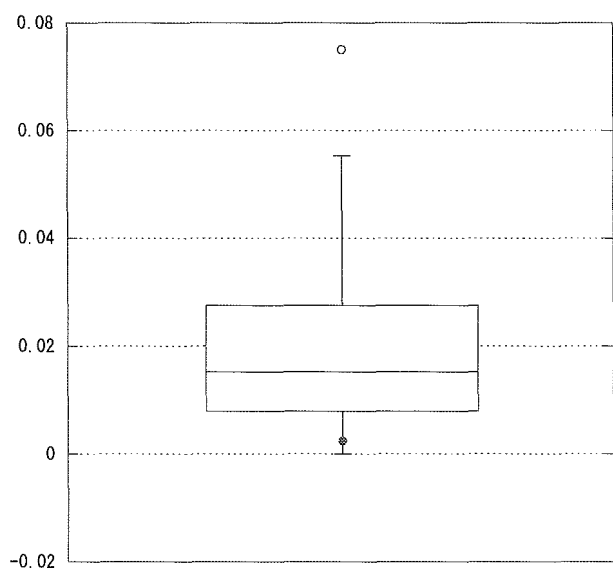

カテ感染率（耐性）

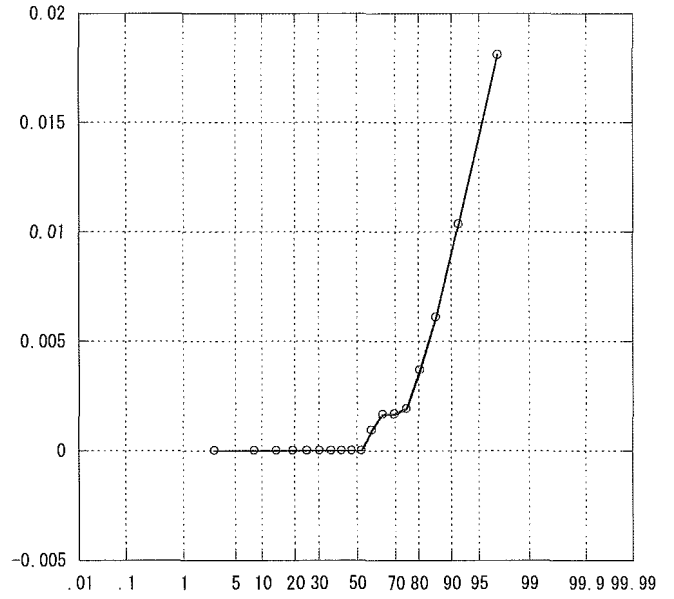
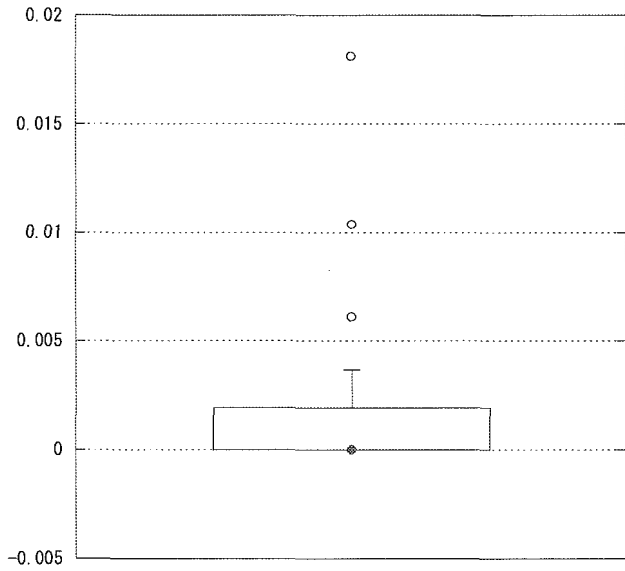

カテ感染率（感性）

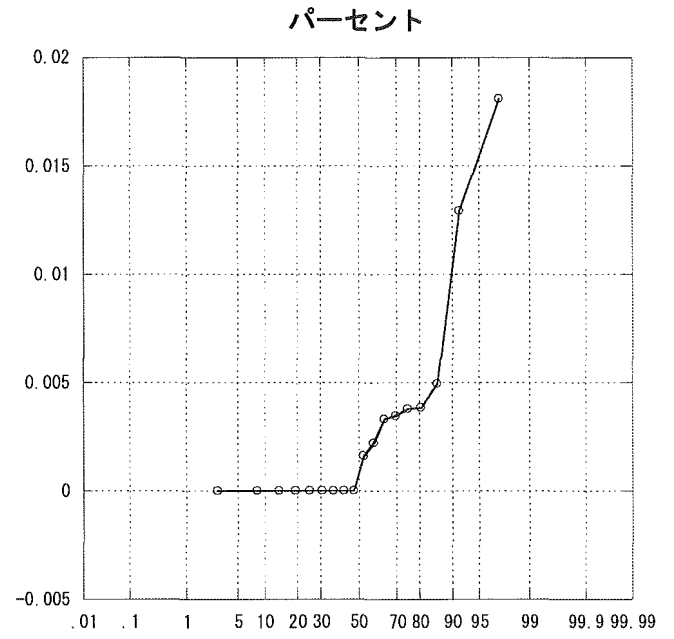
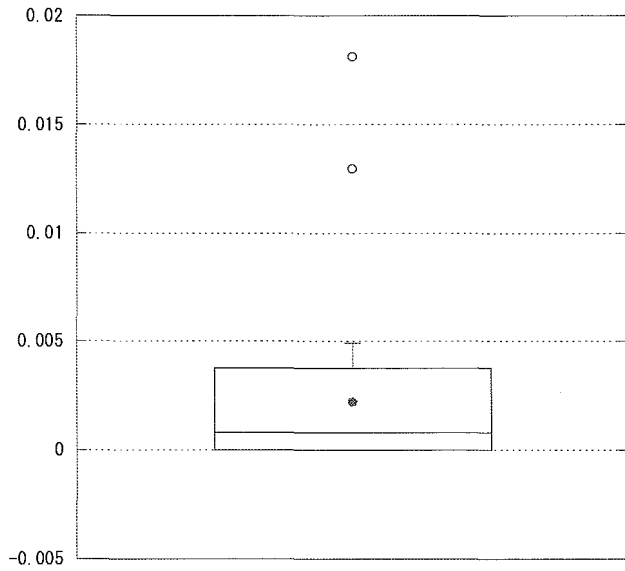

パーセント

創感染率（耐性）

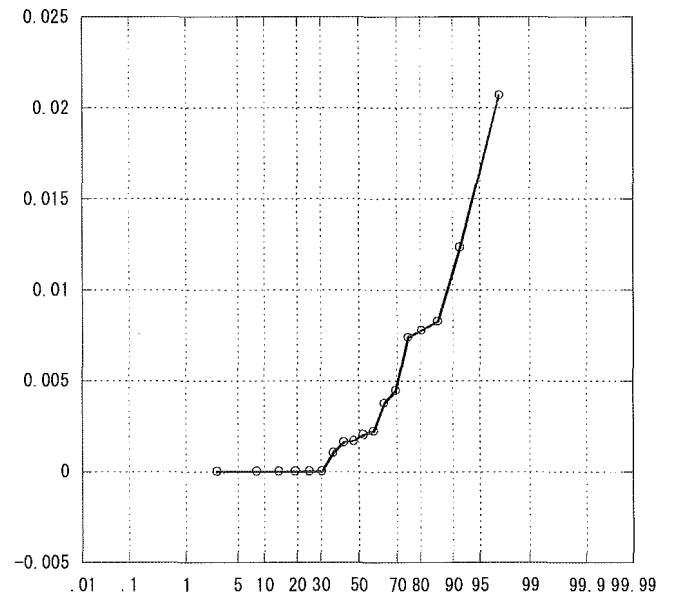
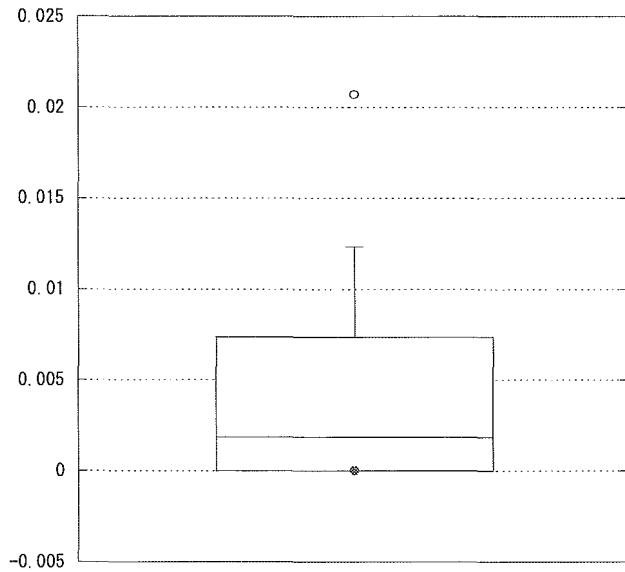

パーセント

ICU研究班2004年施設間比較

創感染率（感性）

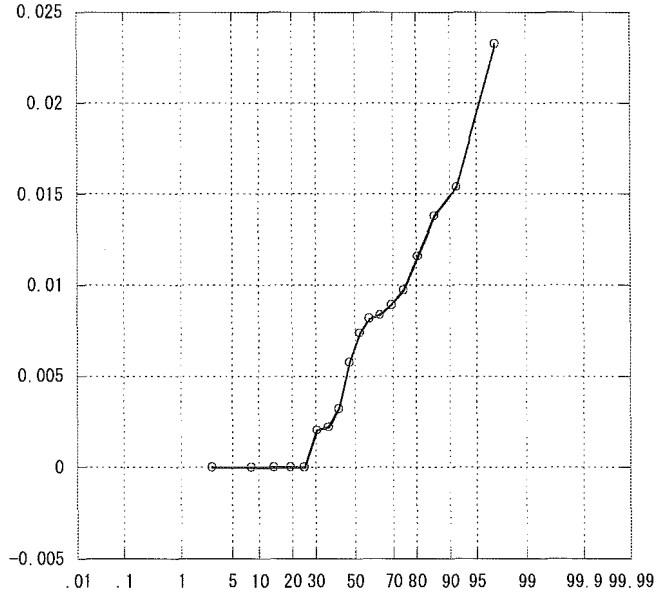
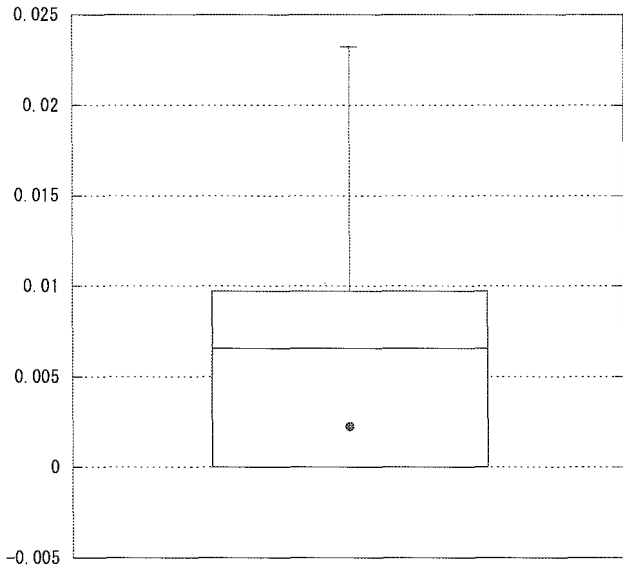

敗血症感染率（耐性）

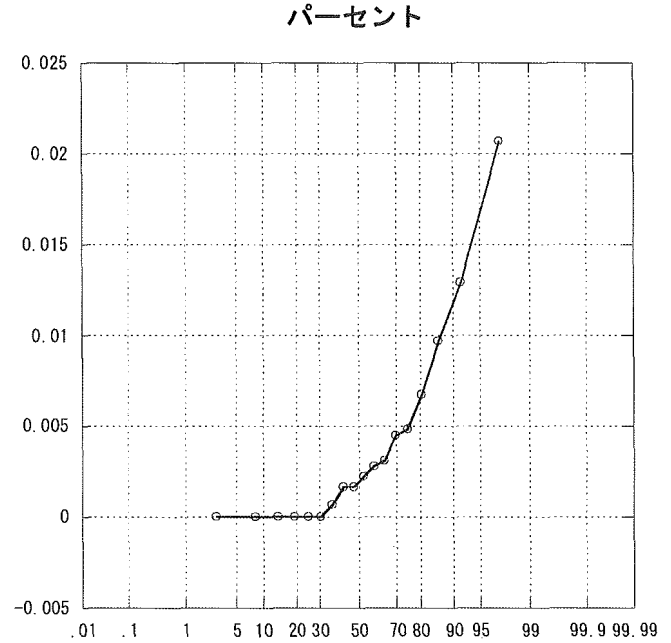
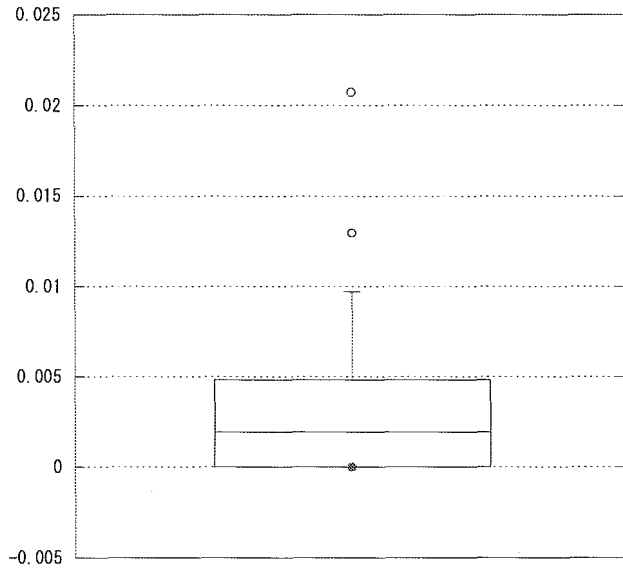

敗血症感染率（感性）

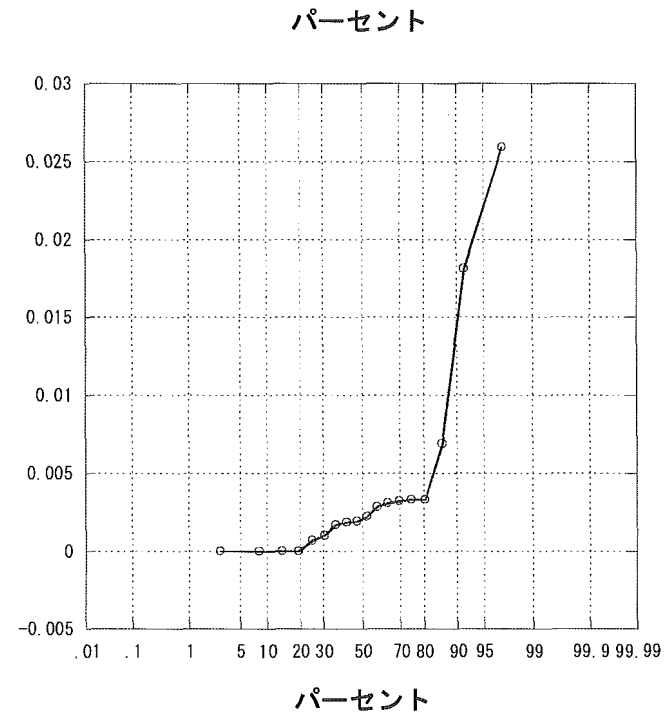
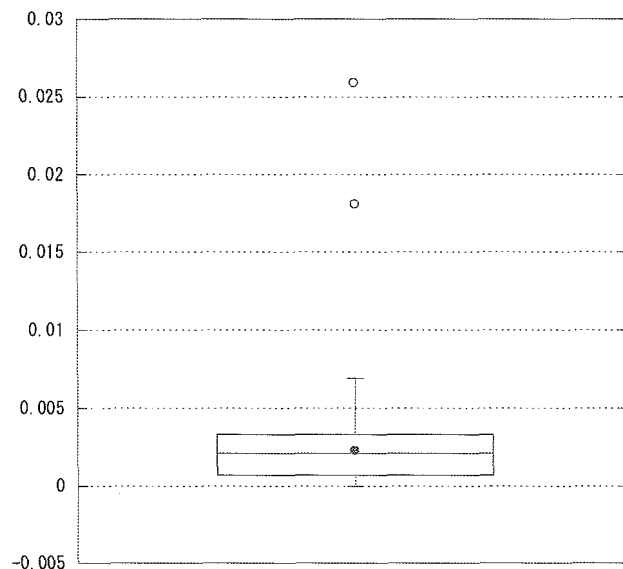

尿路感染率（耐性）

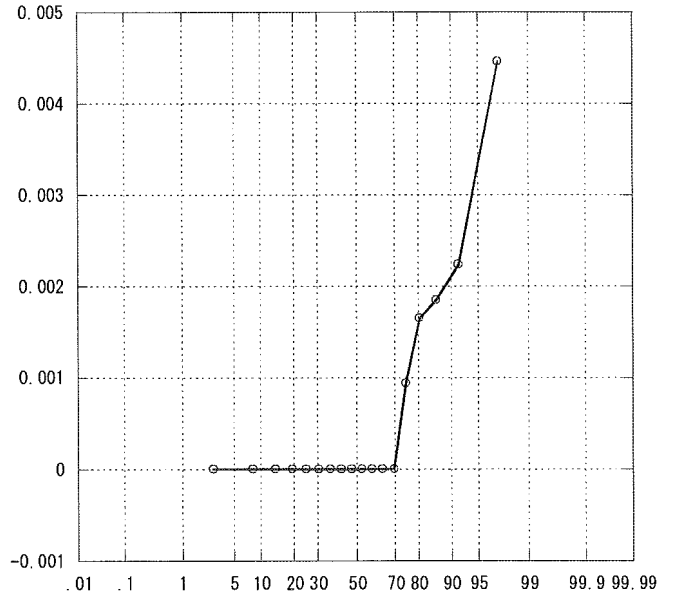
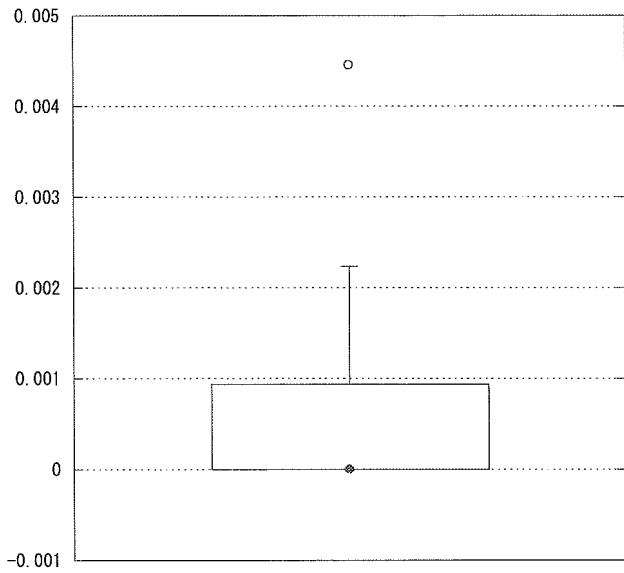

尿路感染率（感性）

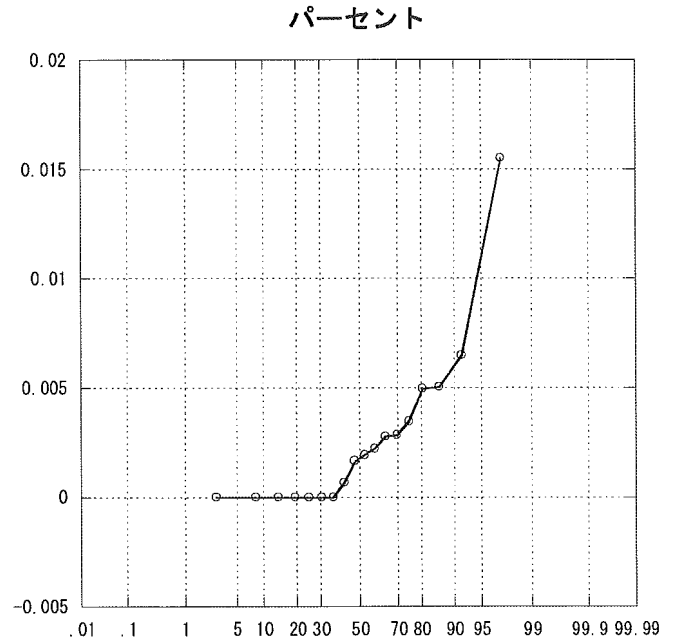
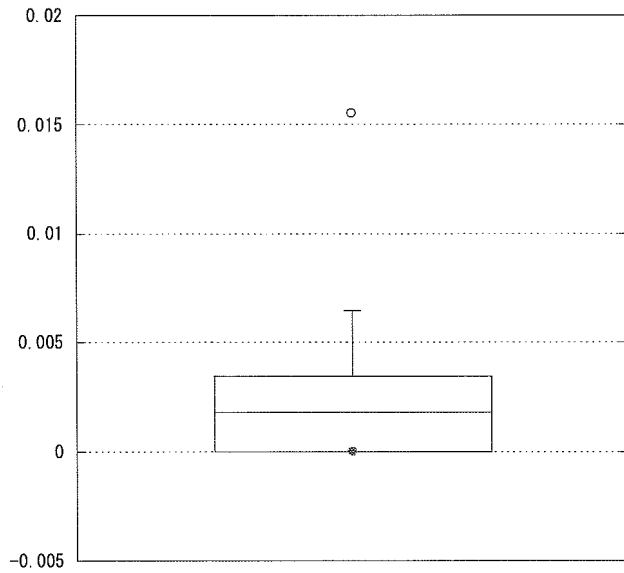

その他感染率（耐性）

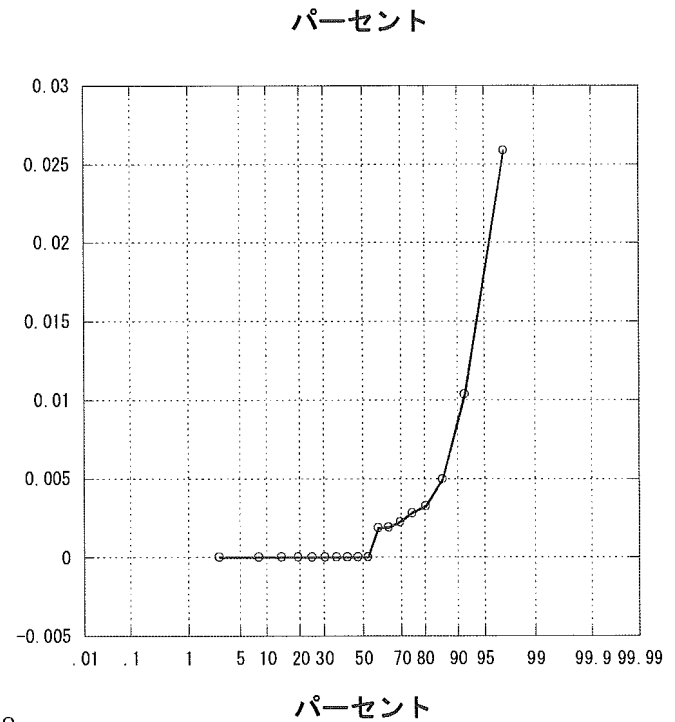
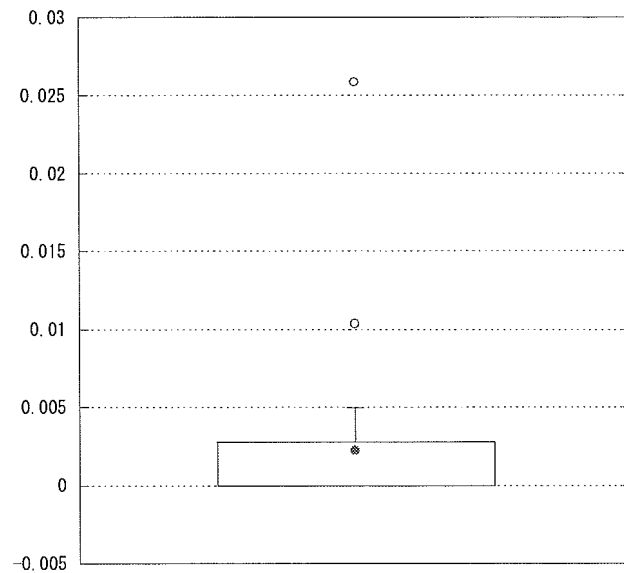

その他感染率（感性）

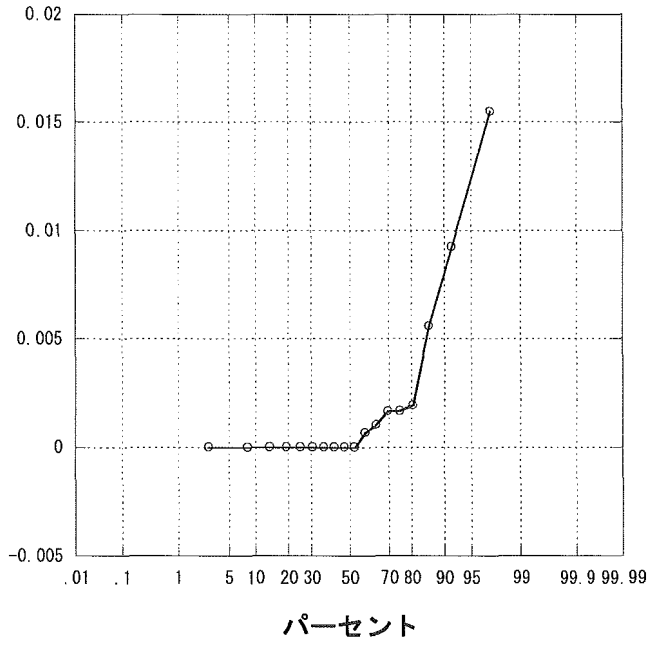
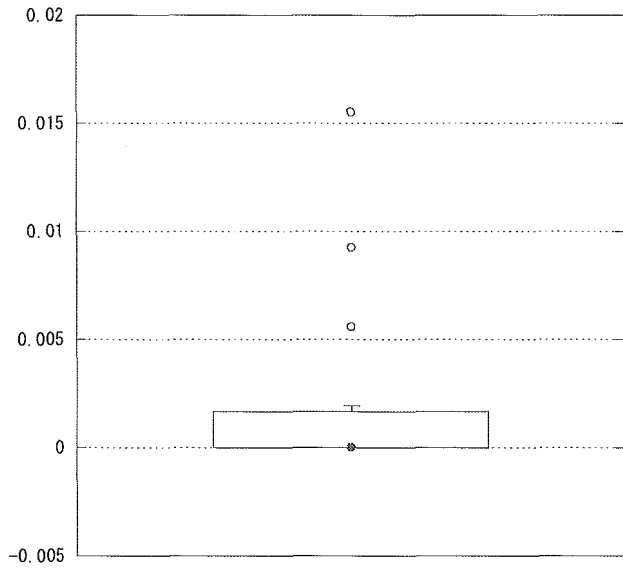

R 施設

2004年1月～12月

ICU研究班2004年施設間比較

年間収容患者数

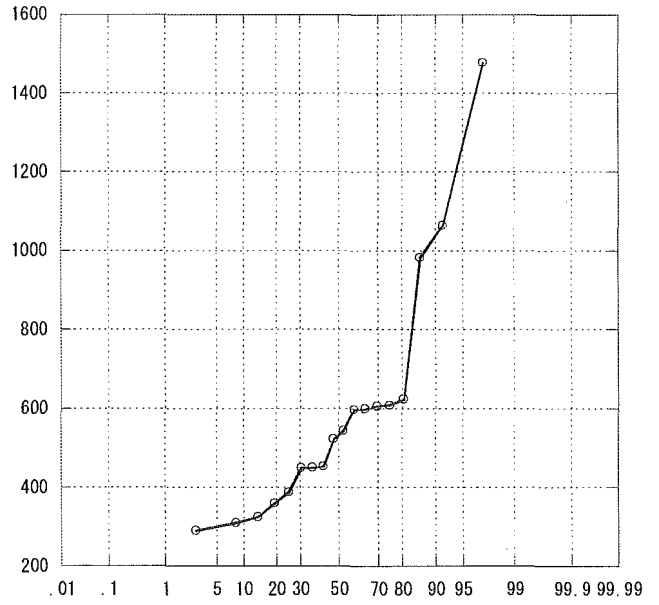
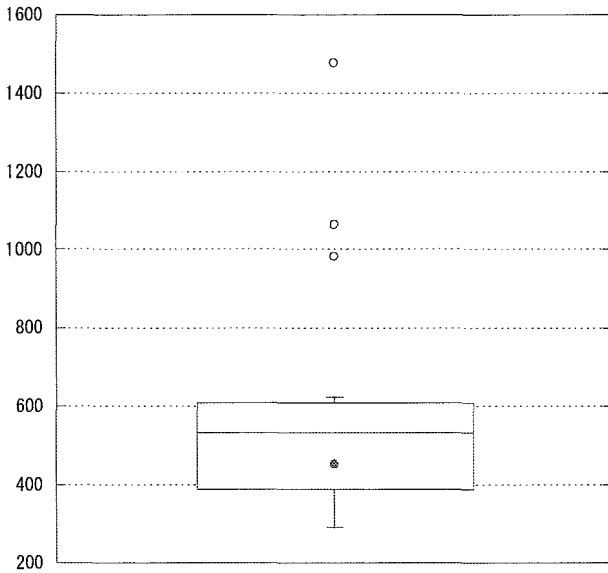

APACHE 0~4

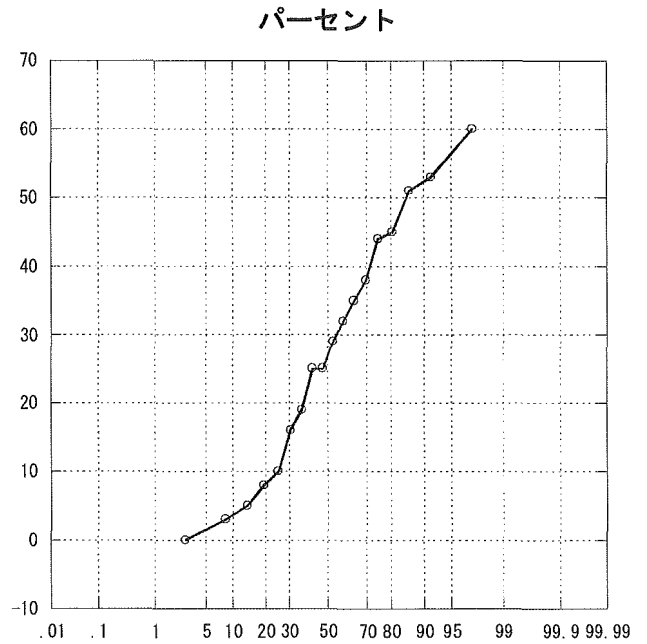
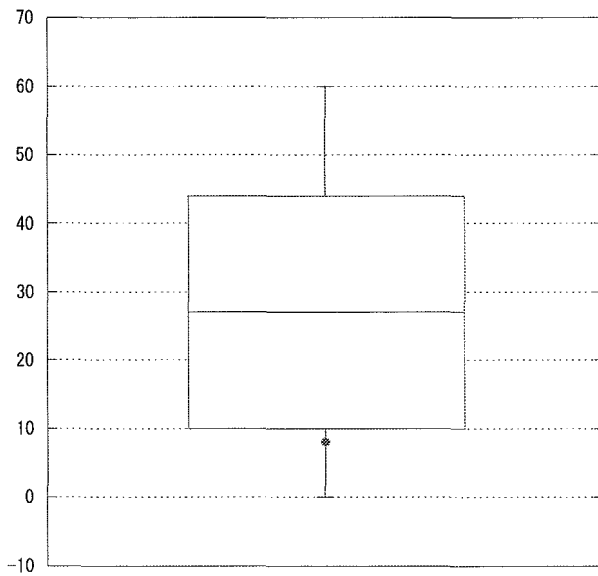

APACHE 5~9

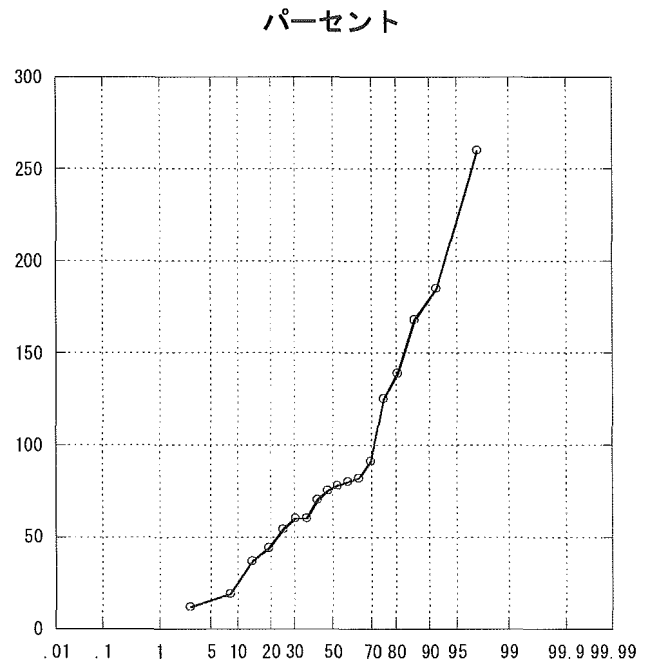
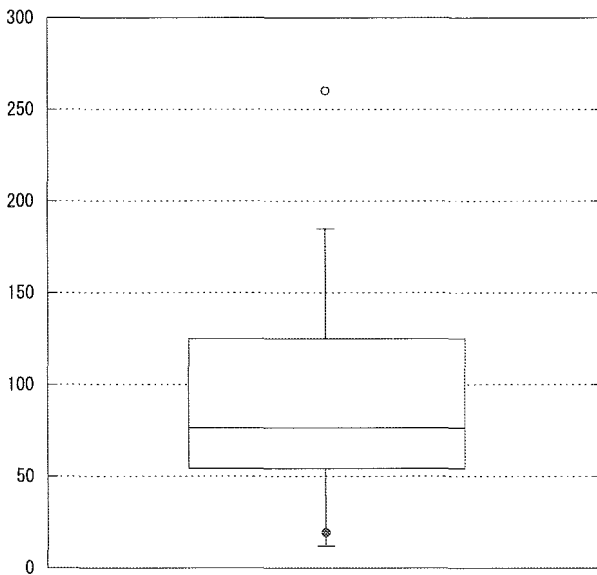

APACHE 10~14

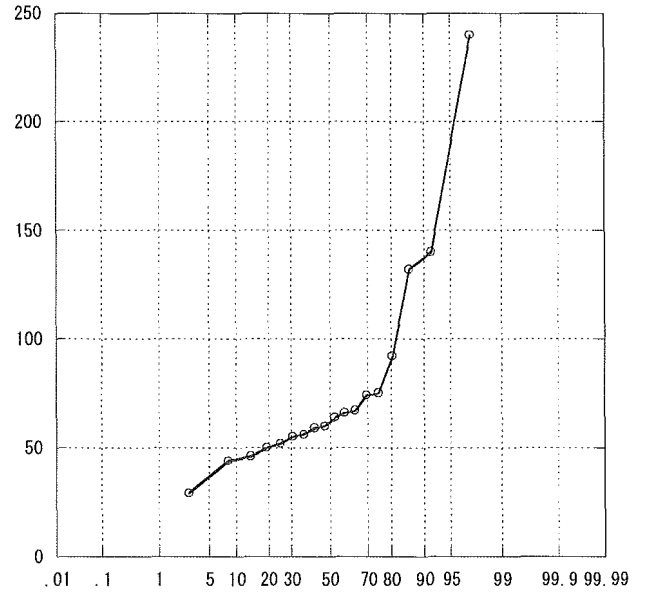
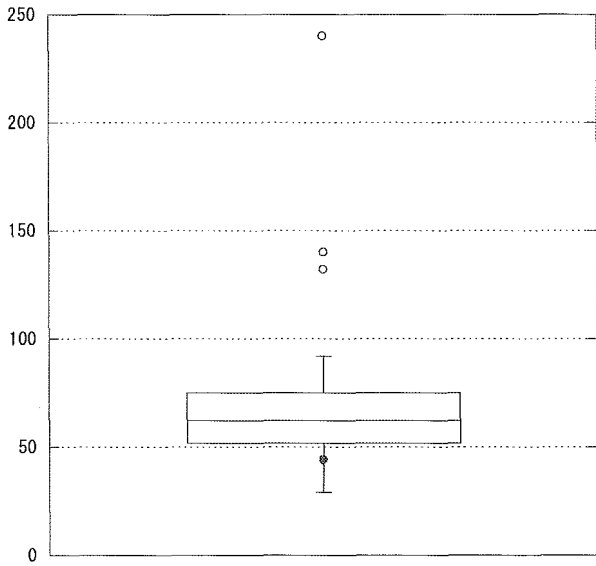

APACHE 15~19

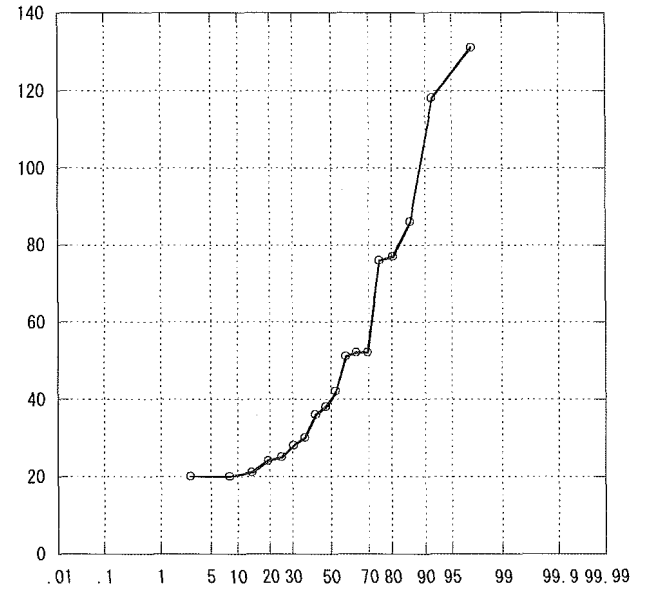
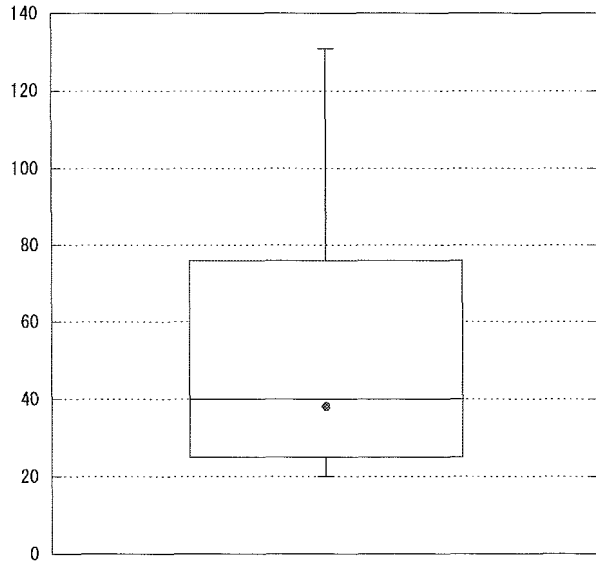

APACHE 20~24

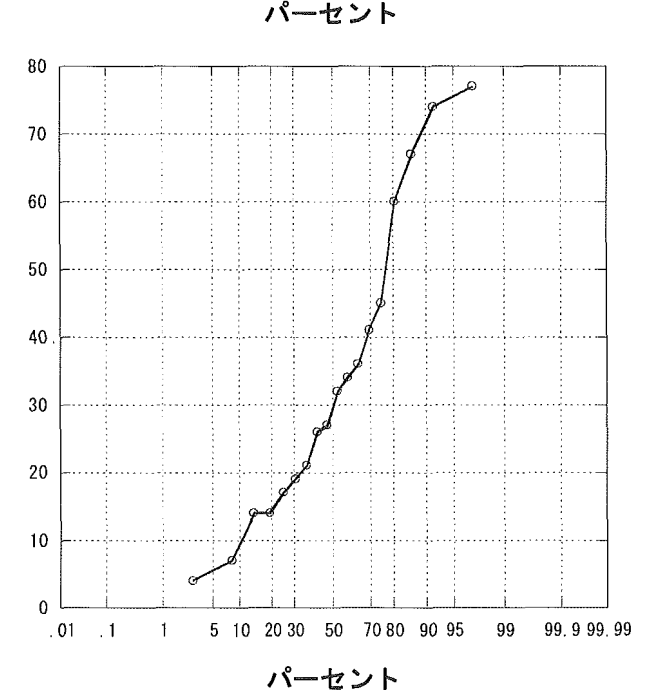
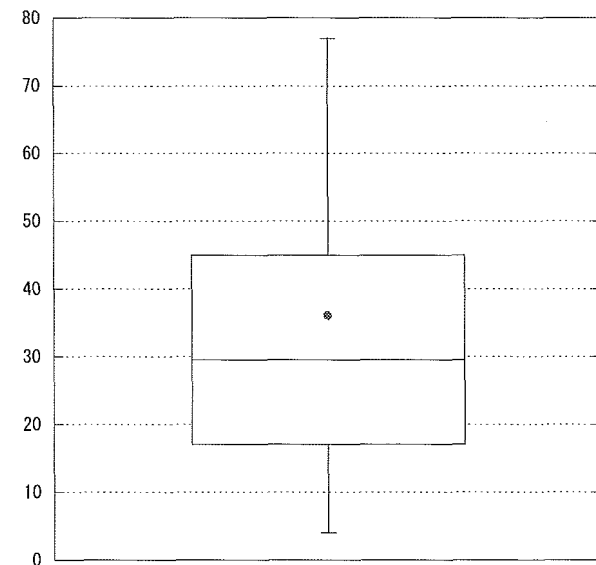

APACHE 25~29

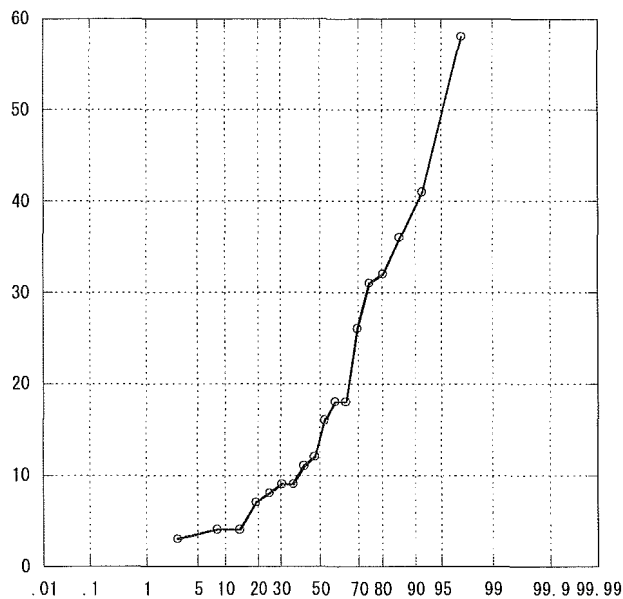
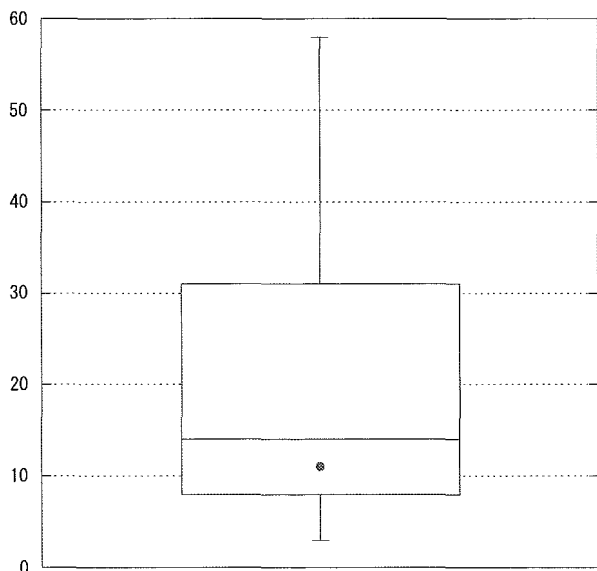

APACHE 30~34

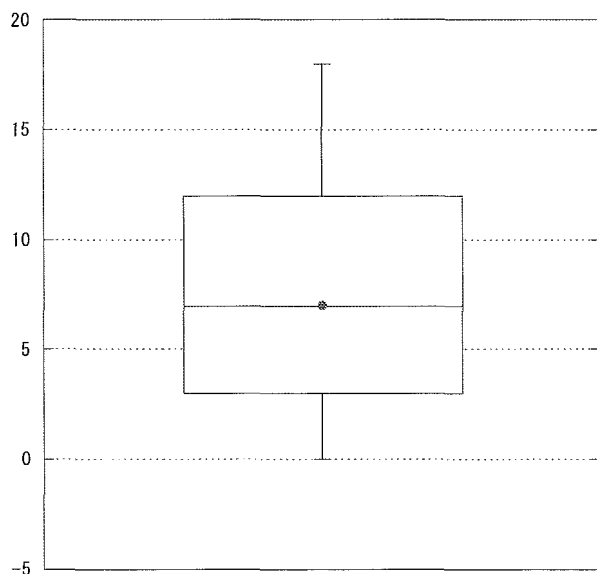

パーセント

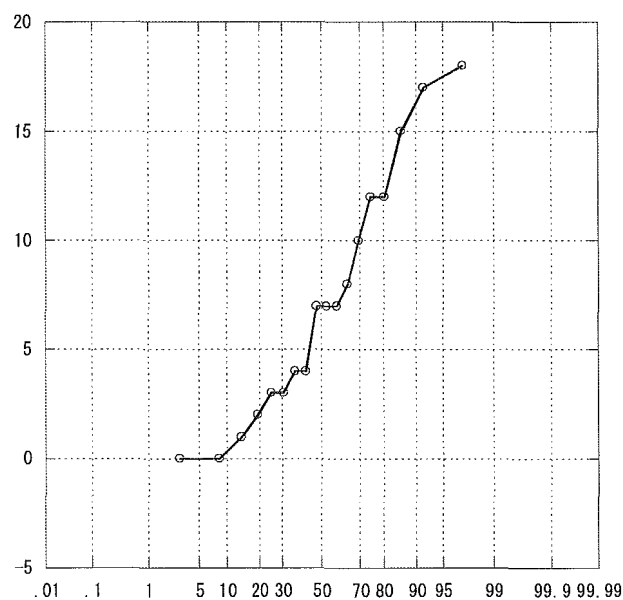

APACHE 35~

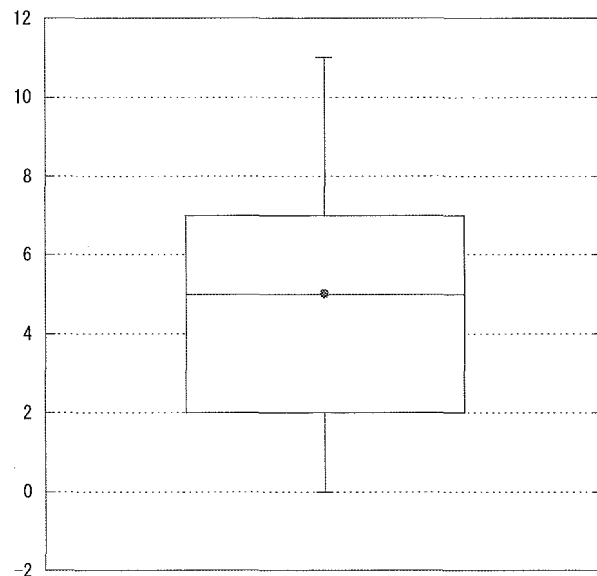

パーセント

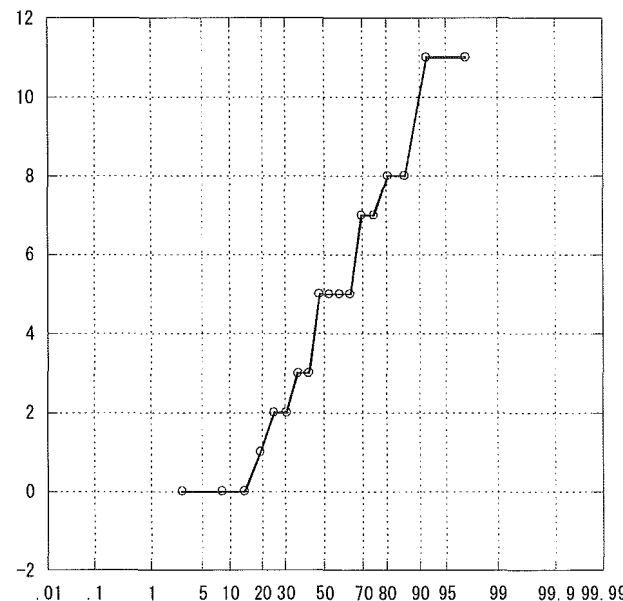

パーセント

APACHE平均

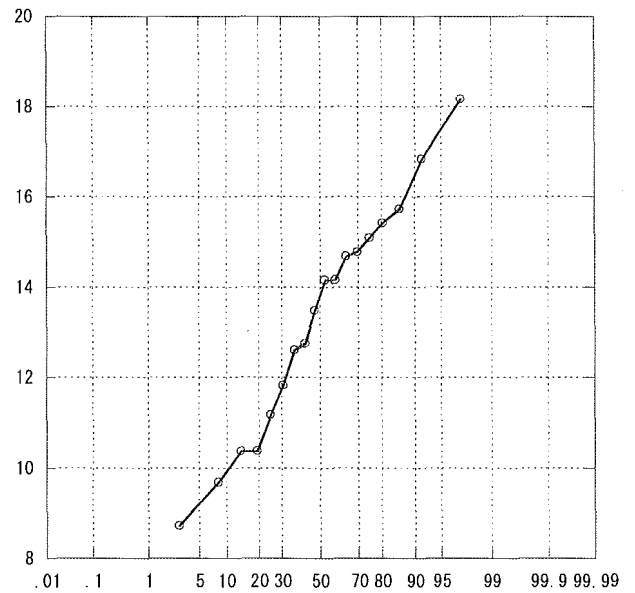
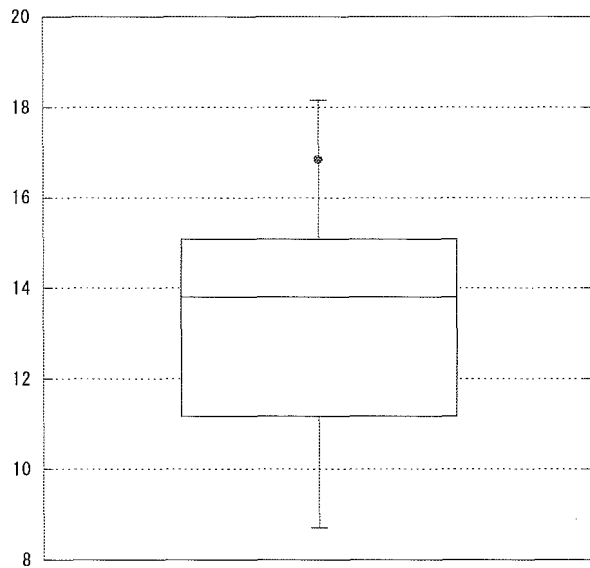

標準化死亡比

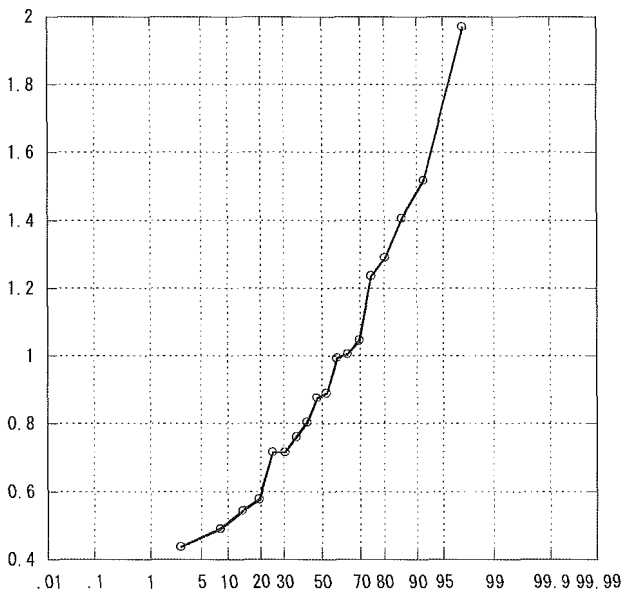
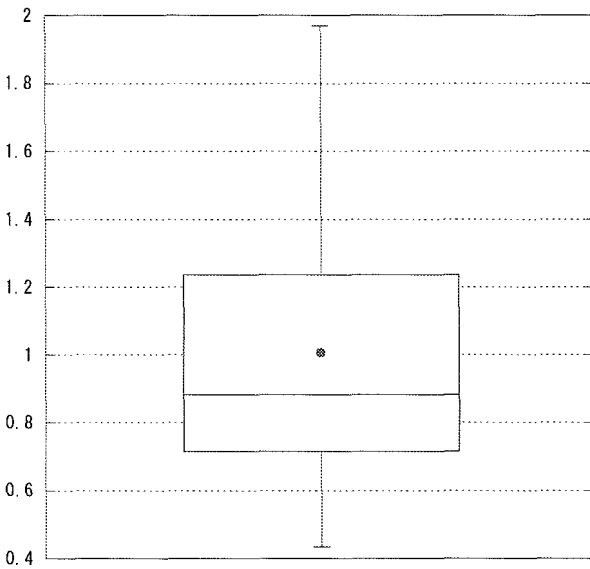

平均在室日数

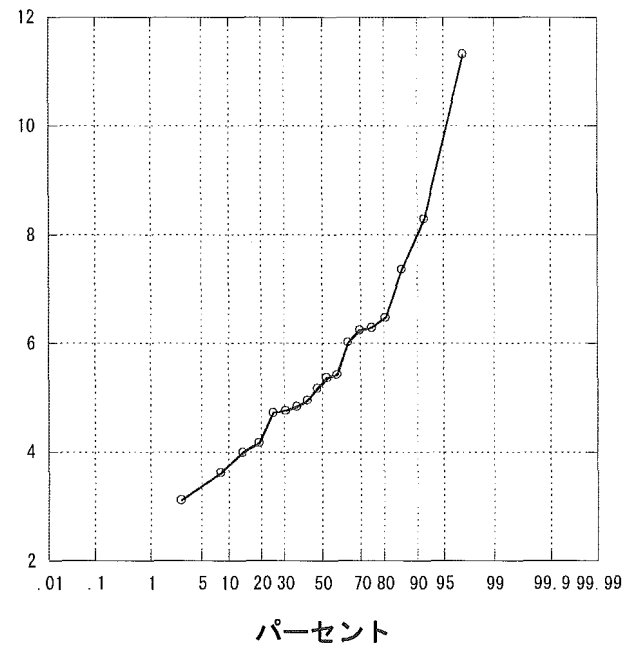
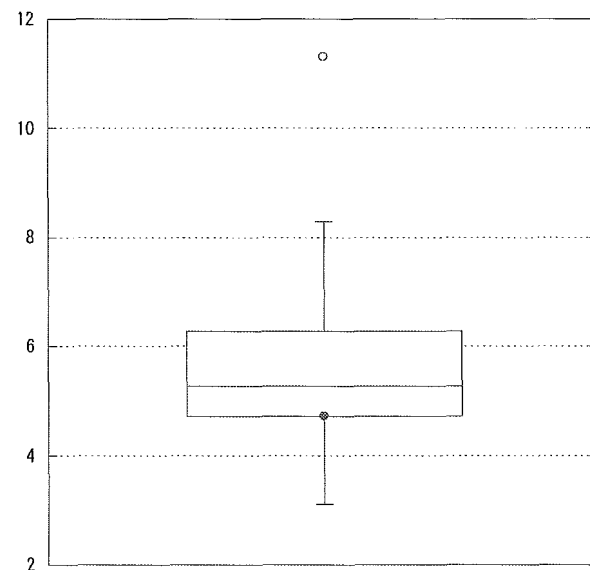

平均在院日数

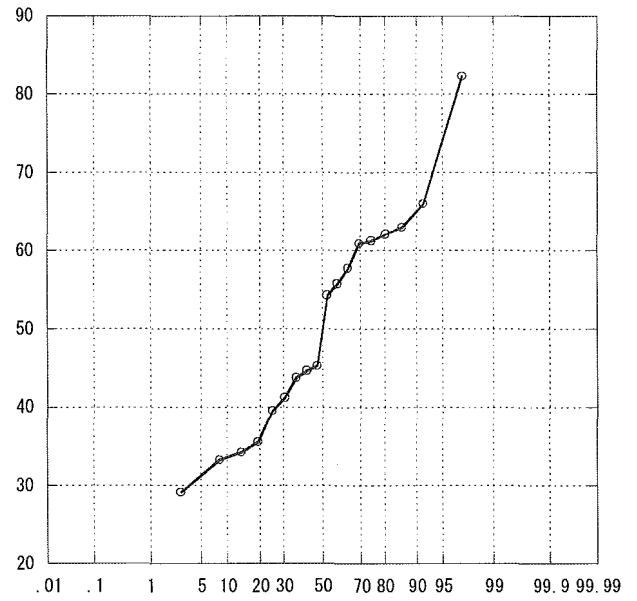
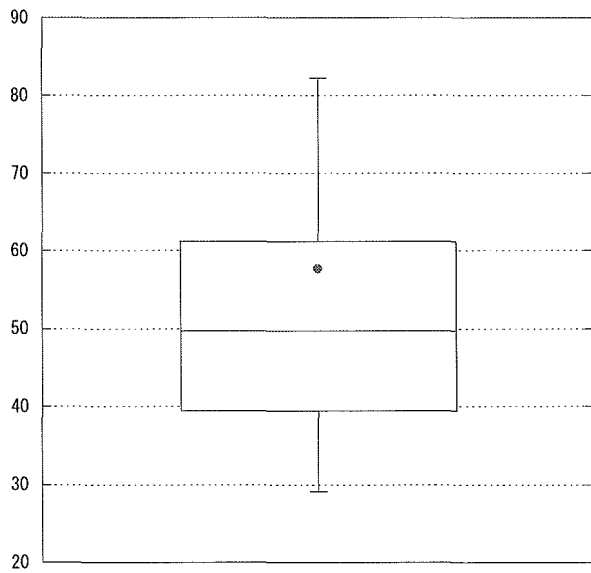

人工呼吸器利用率

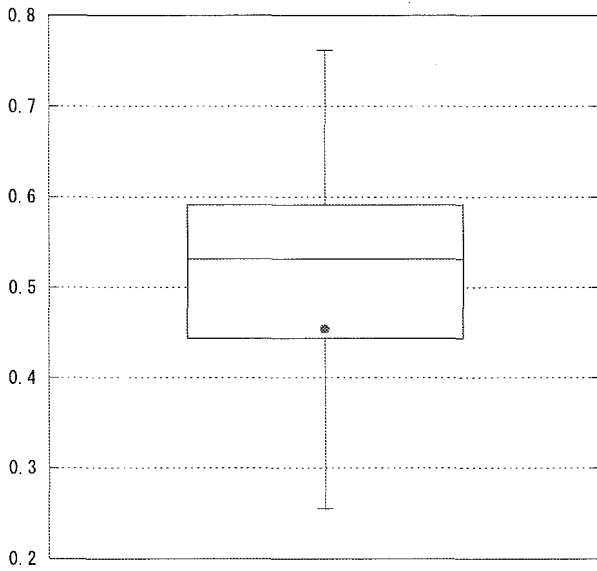

パーセント

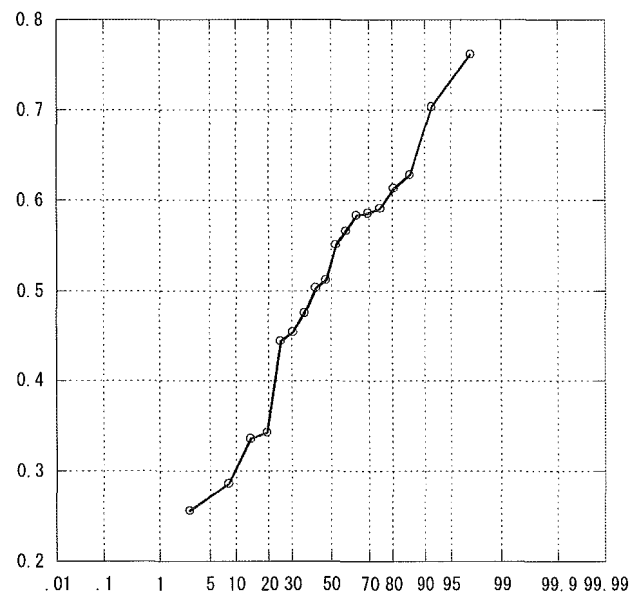

中心静脈カテ利用率

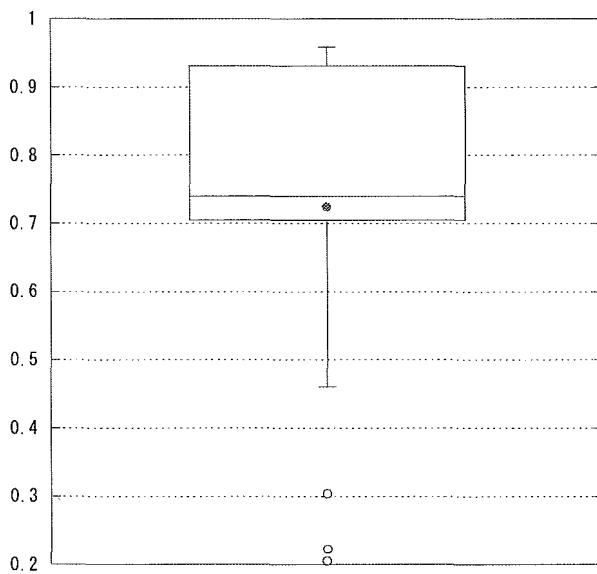

パーセント

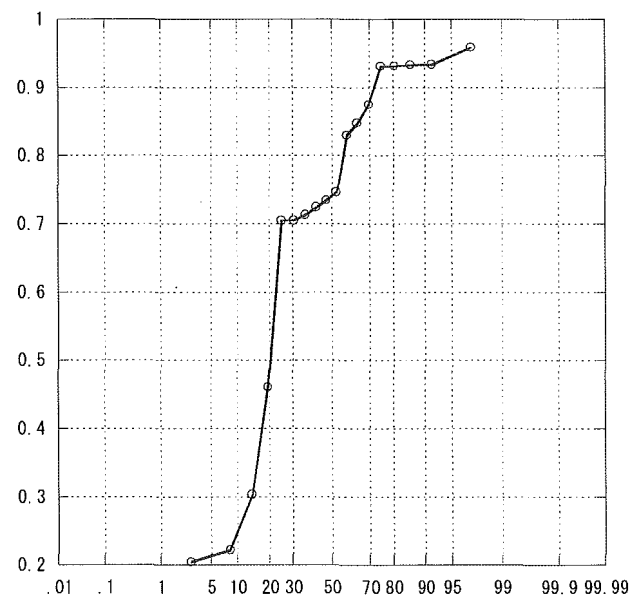

パーセント

尿道カテ利用率

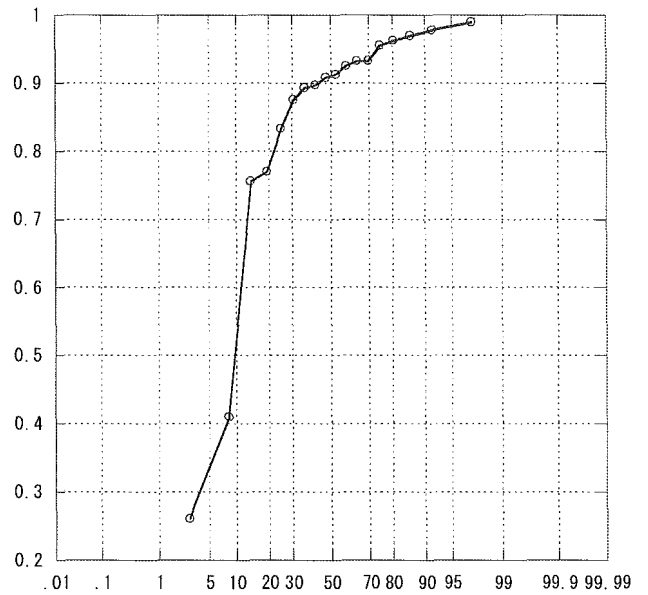
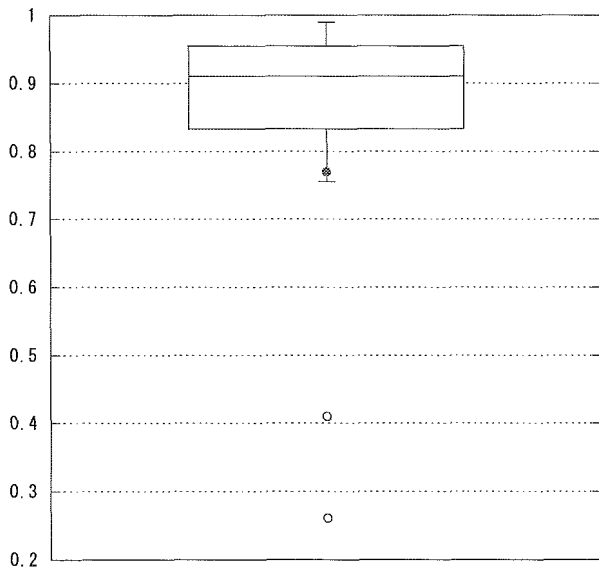

人工呼吸日／患者数

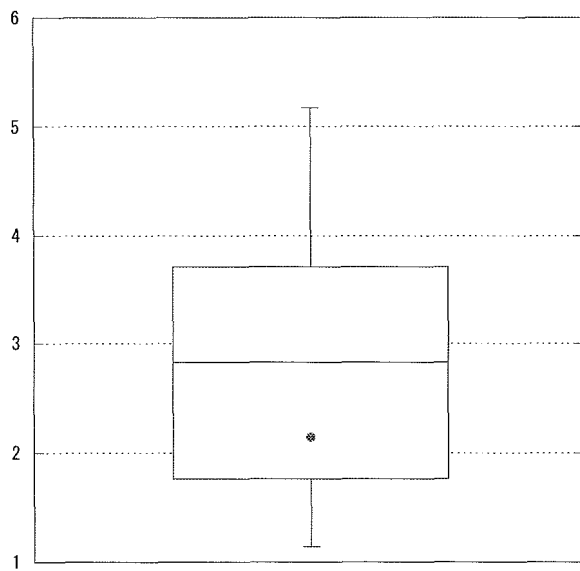

パーセント

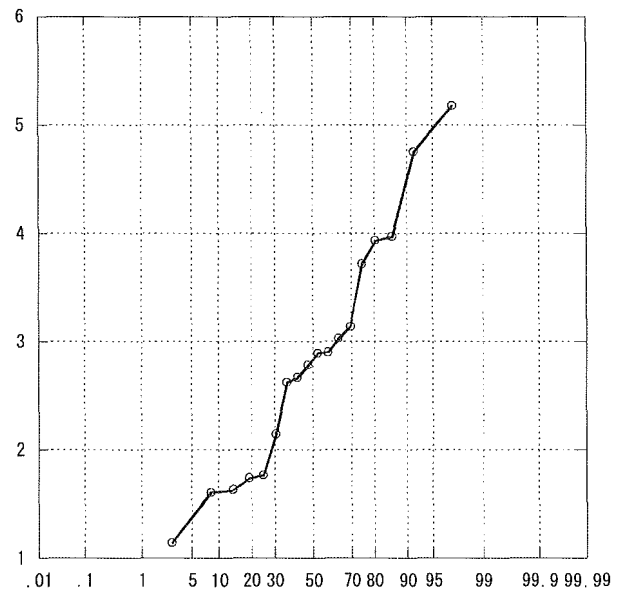

リスク調整感染率（肺炎）

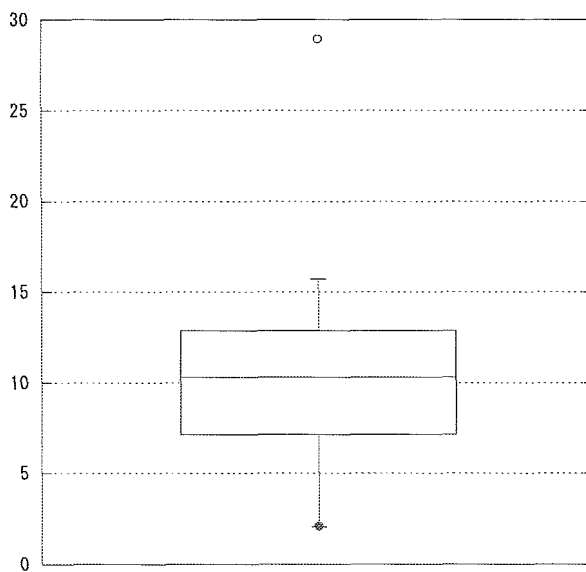

パーセント

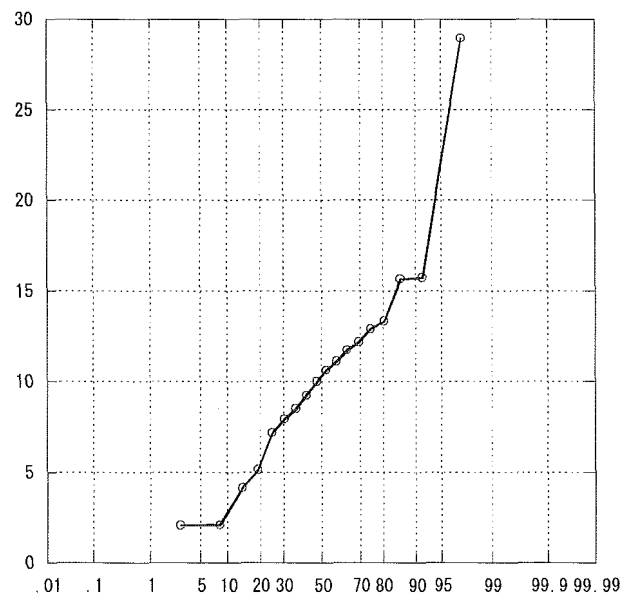

パーセント

ICU研究班2004年施設間比較

リスク調整感染率（カテ）

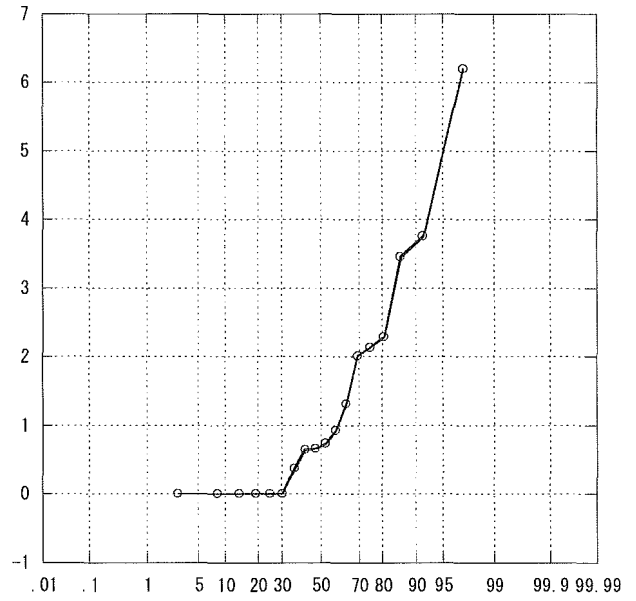
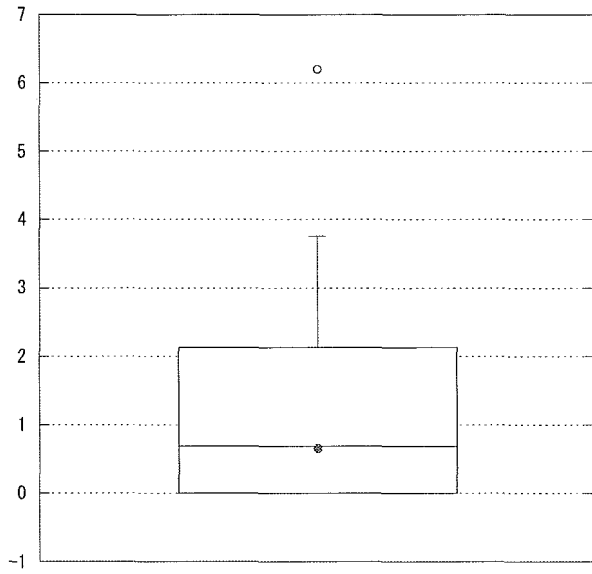

リスク調整感染率（尿路）

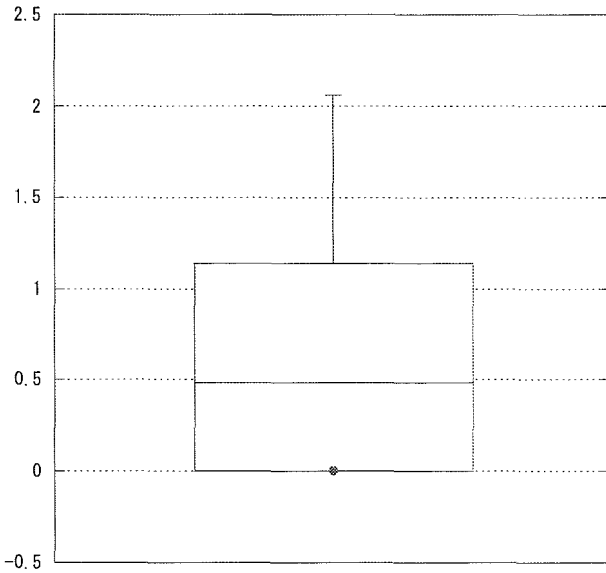

パーセント

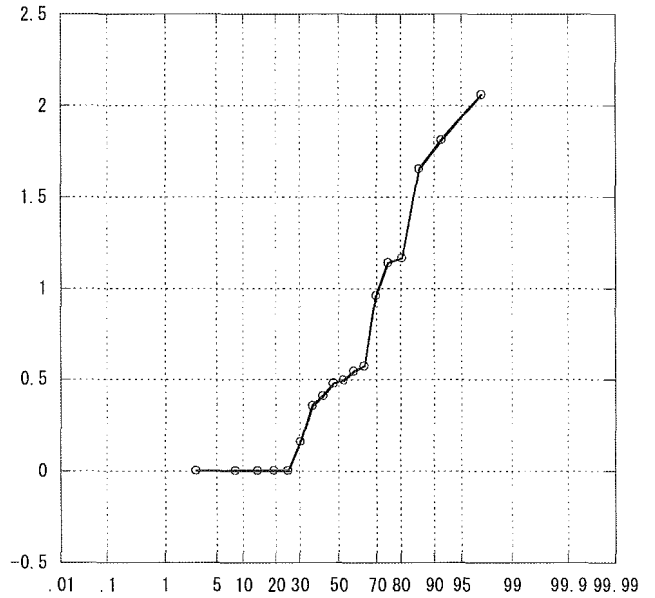

全感染率（耐性）

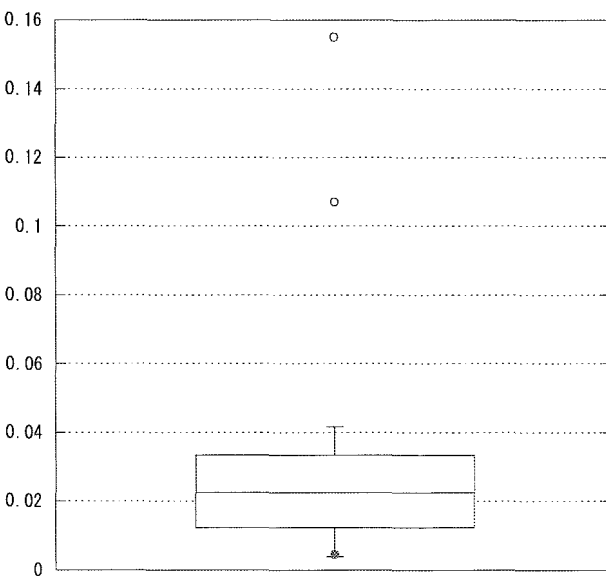

パーセント

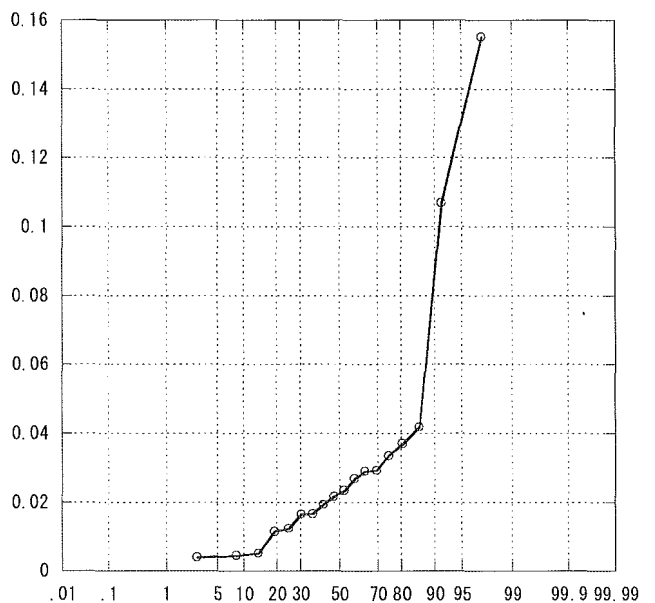

パーセント

全感染率（感性）

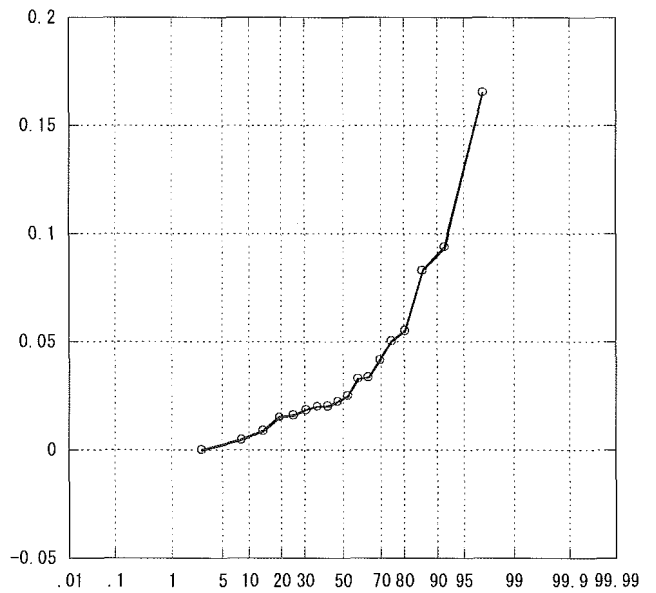
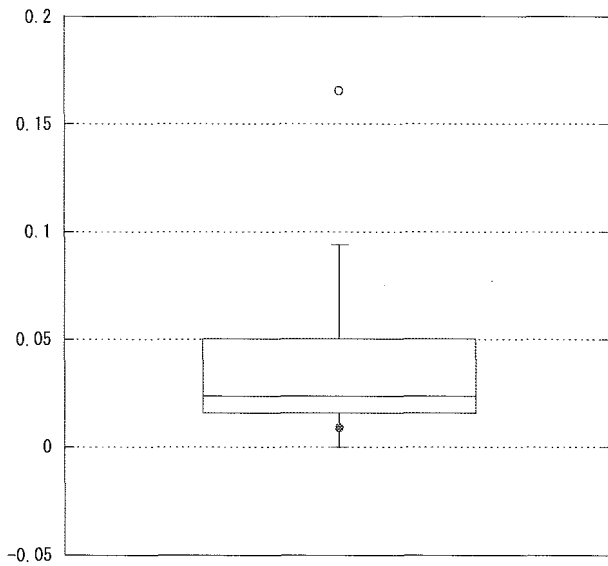

肺炎感染率（耐性）

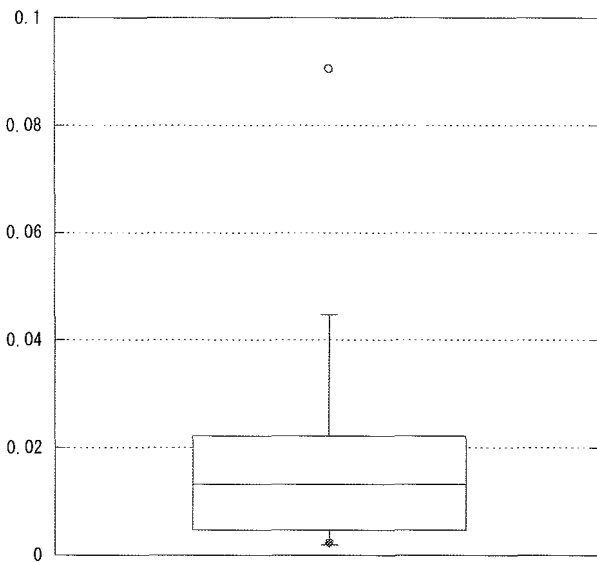

パーセント

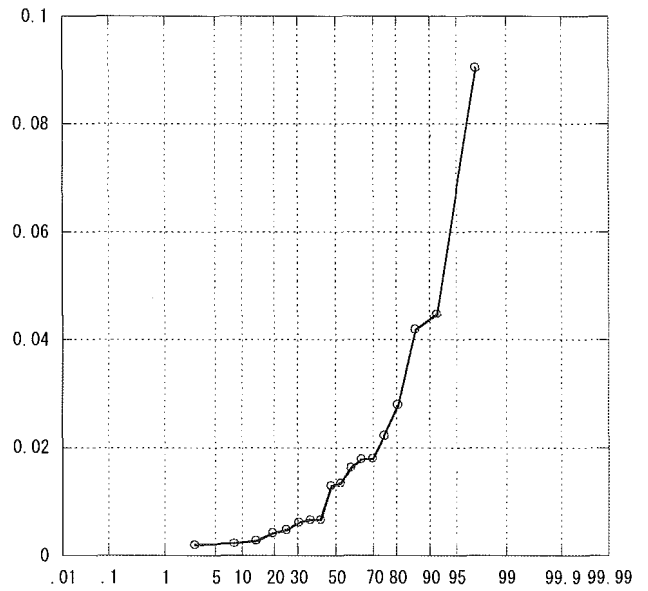

肺炎感染率（感性）

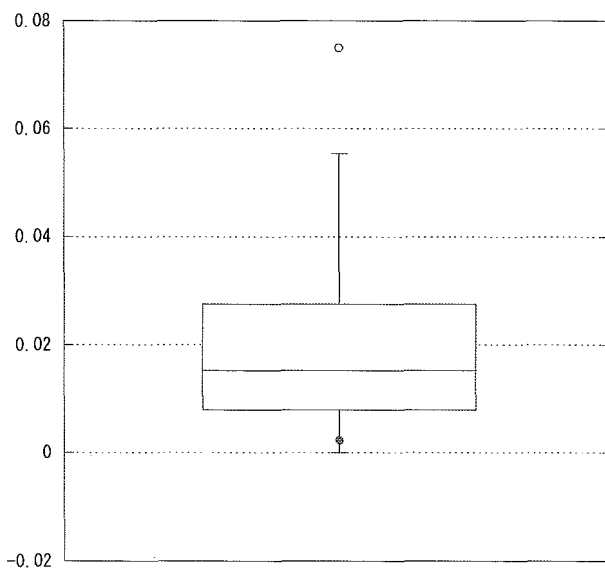

パーセント

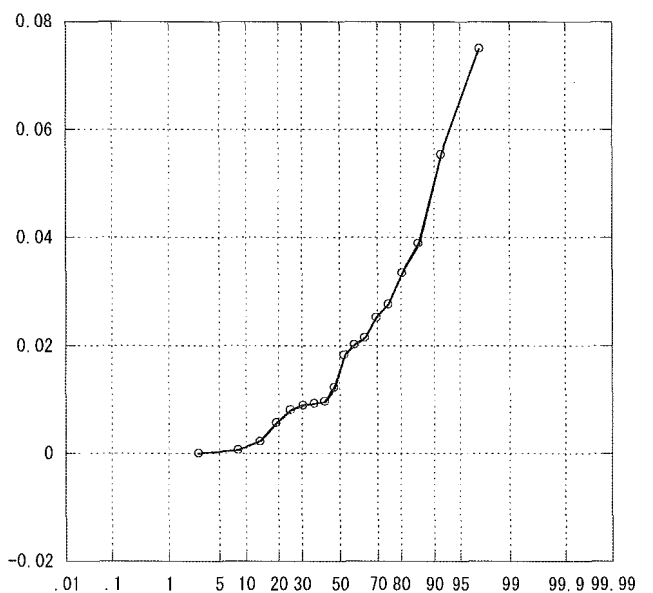

パーセント