

# 診療科間比較

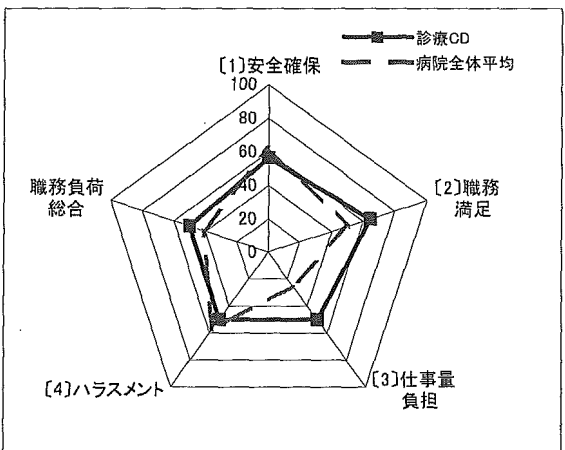

# 診療科間比較

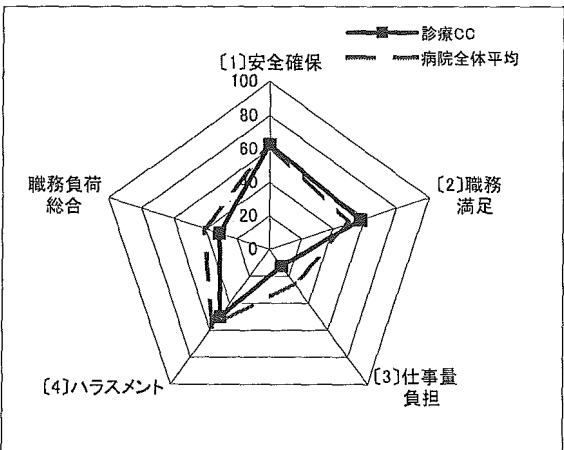
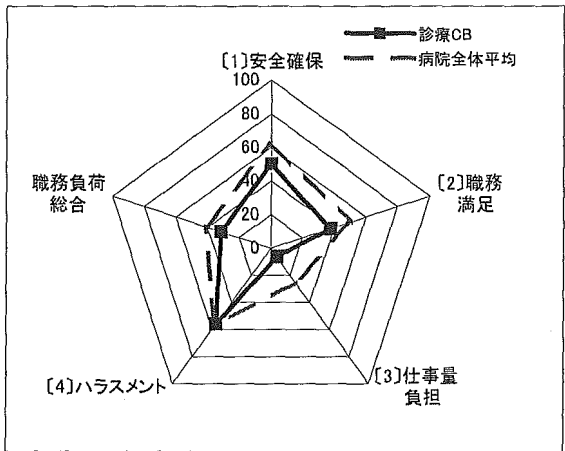
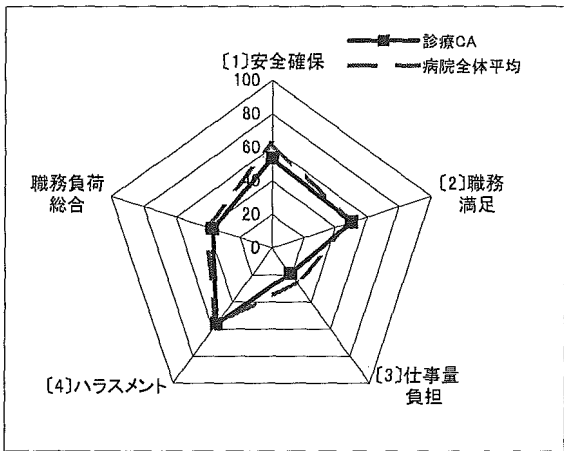
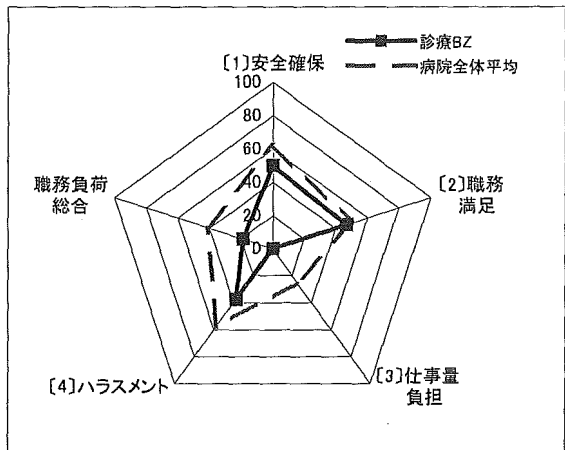
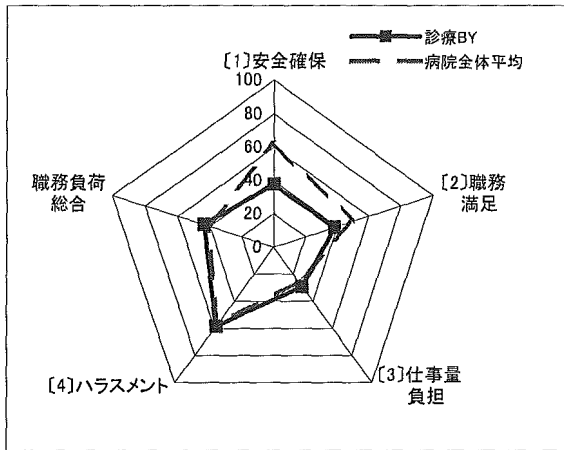
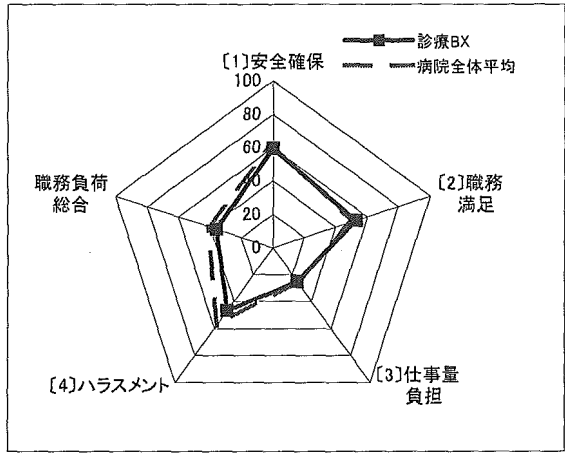
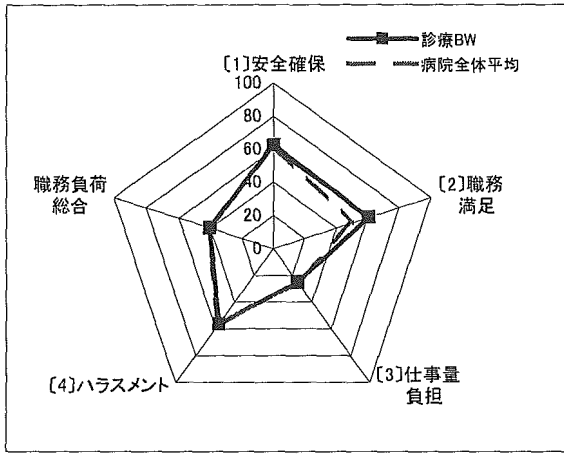
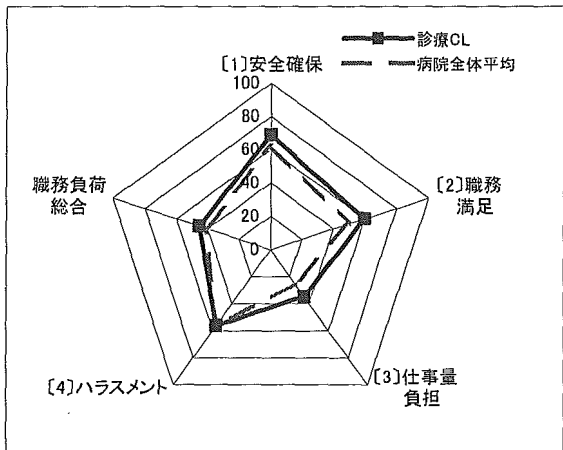
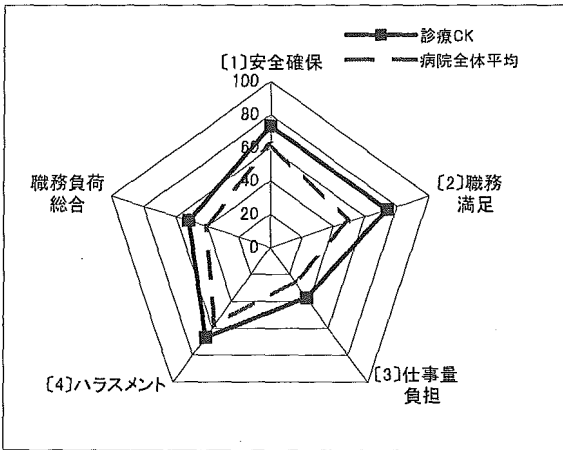
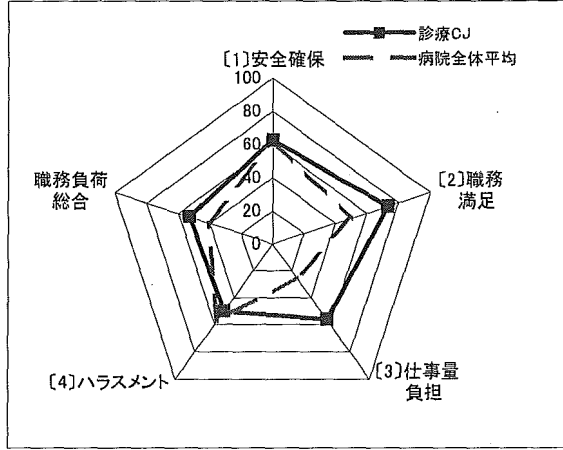
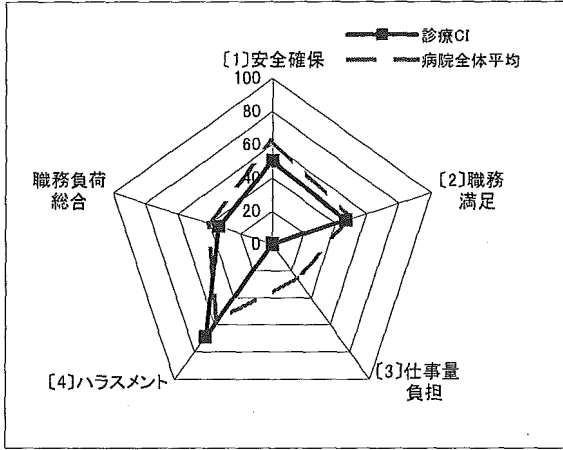
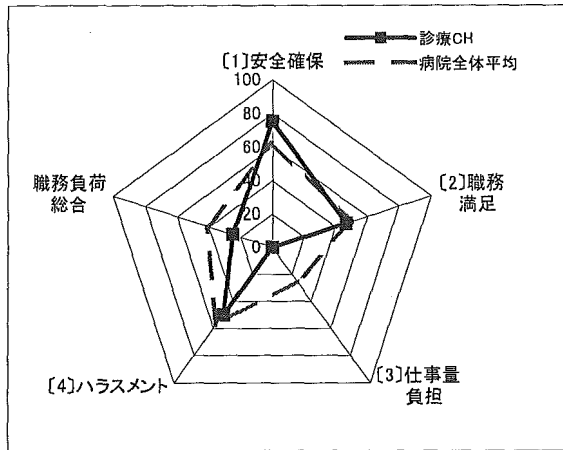
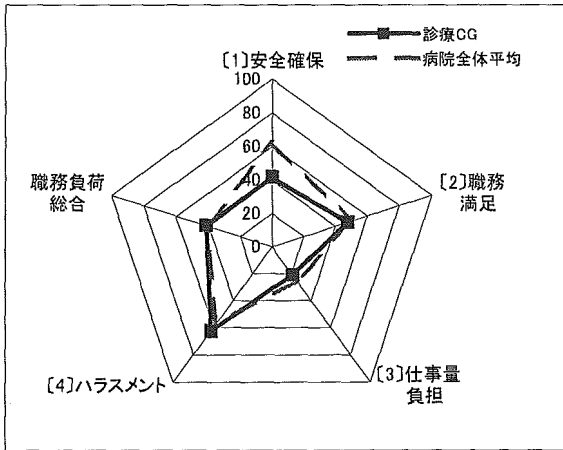
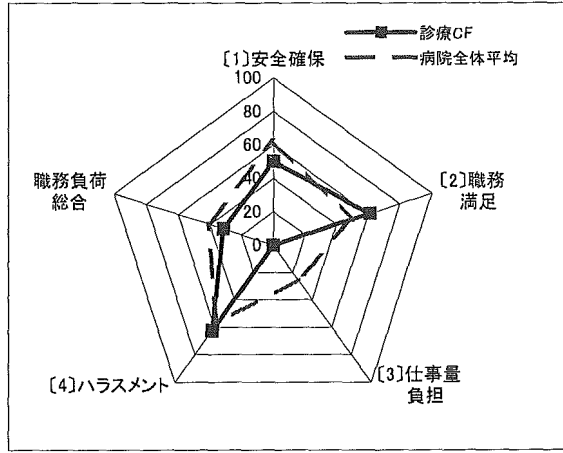
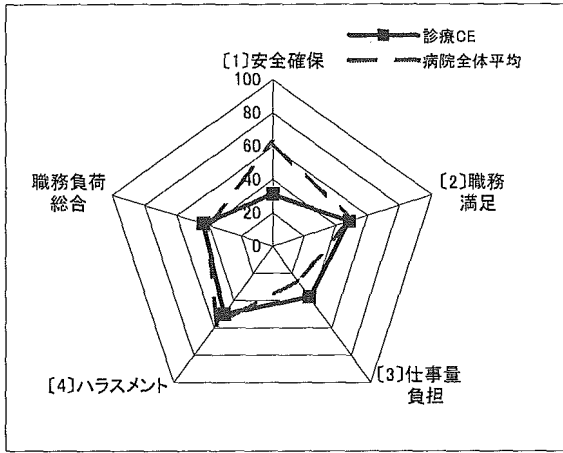

# ■ 診療科間比較

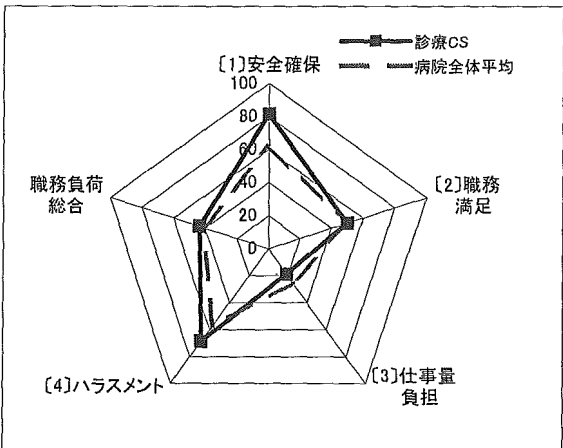
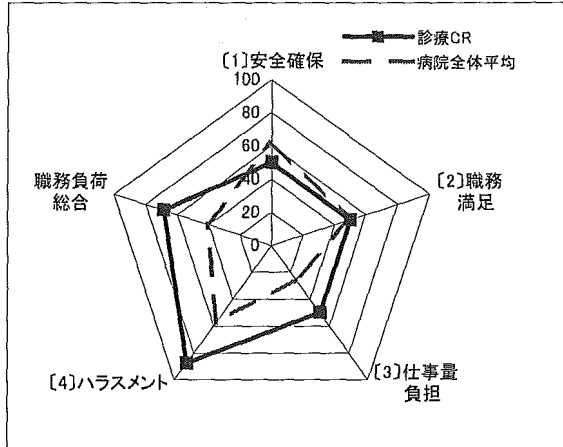
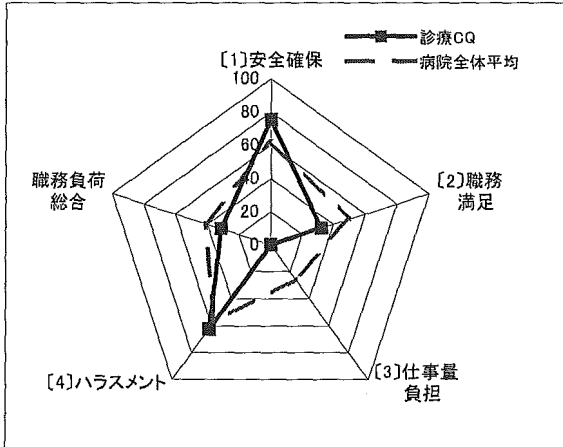
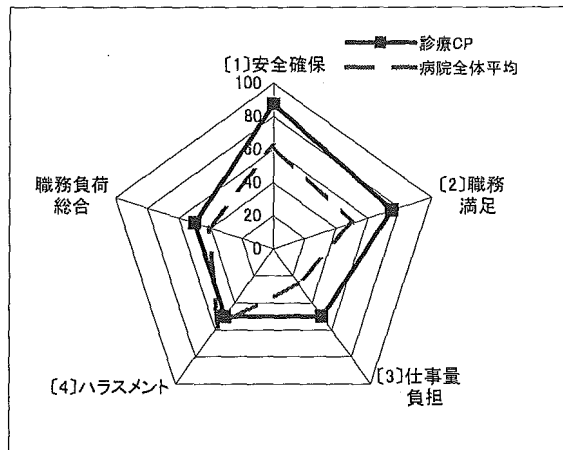
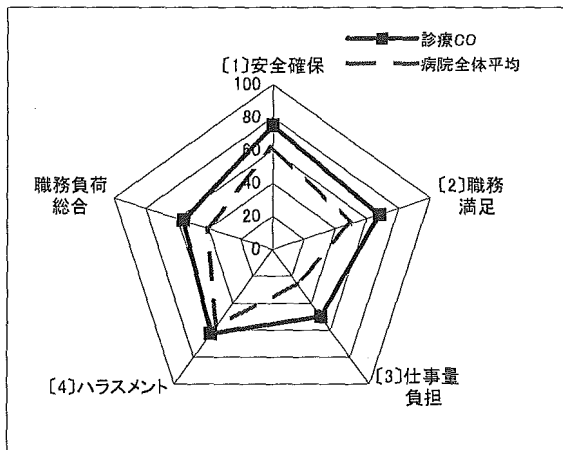
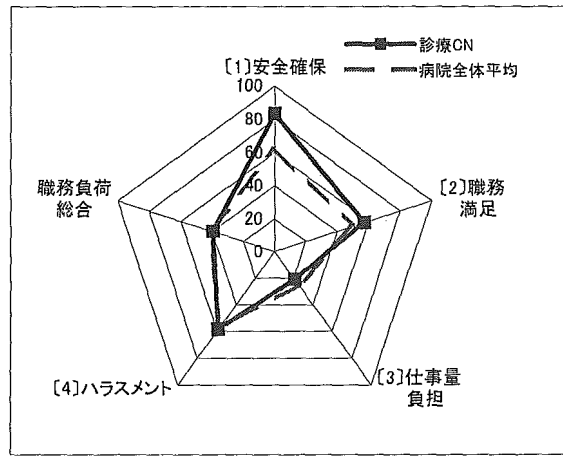
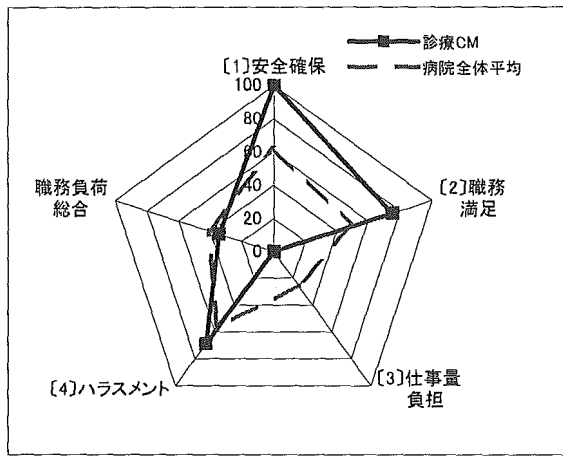

# ■ 病棟間比較

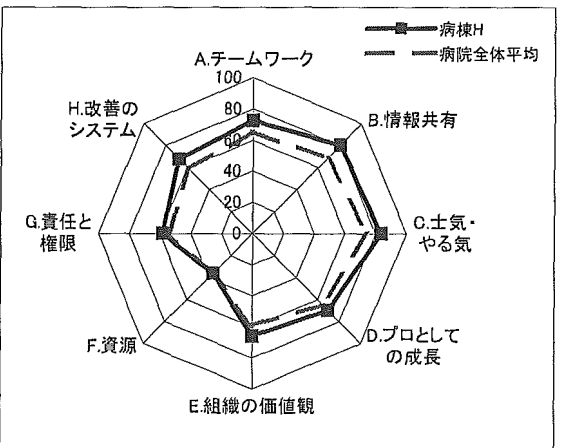
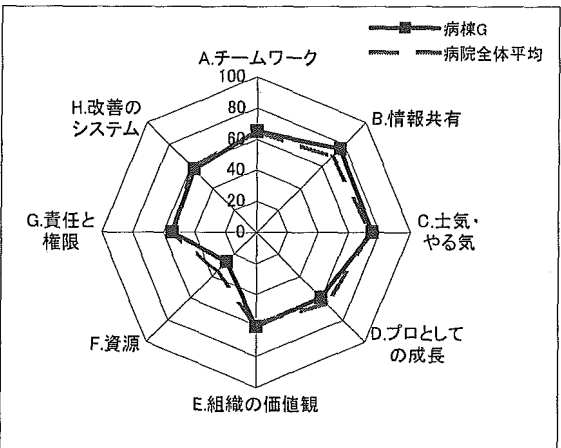
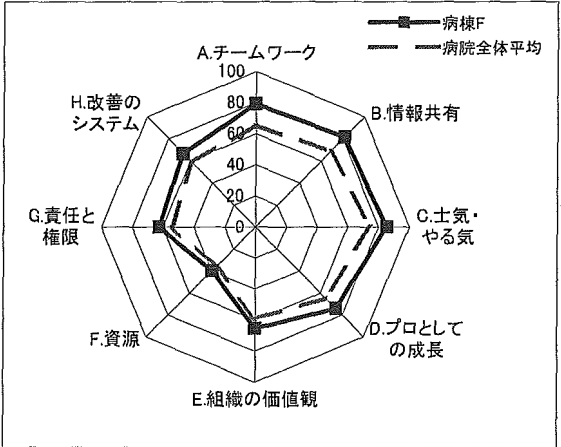
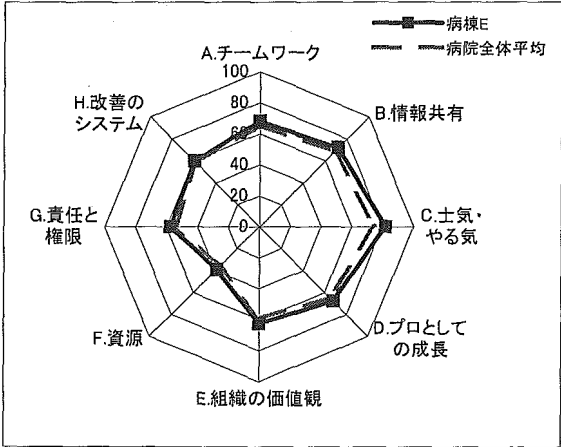
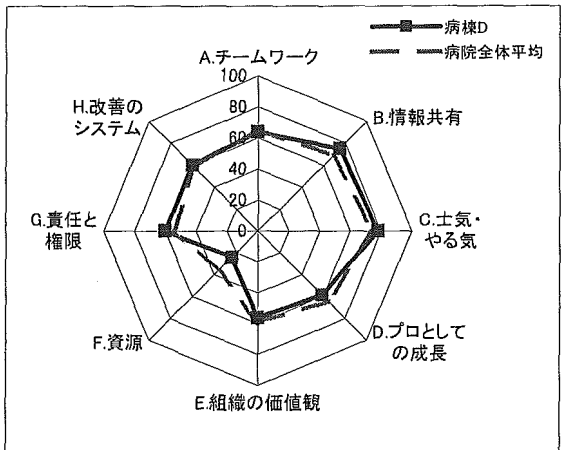
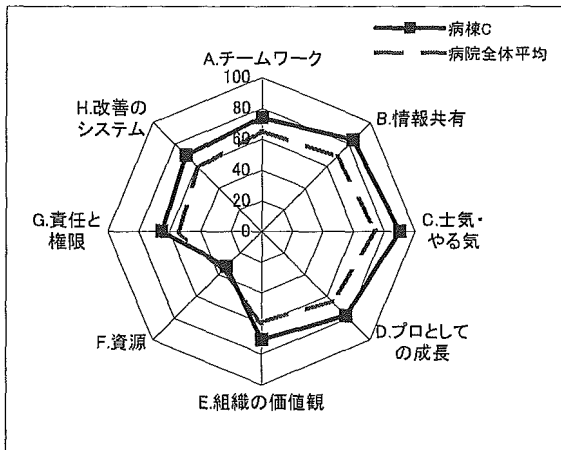
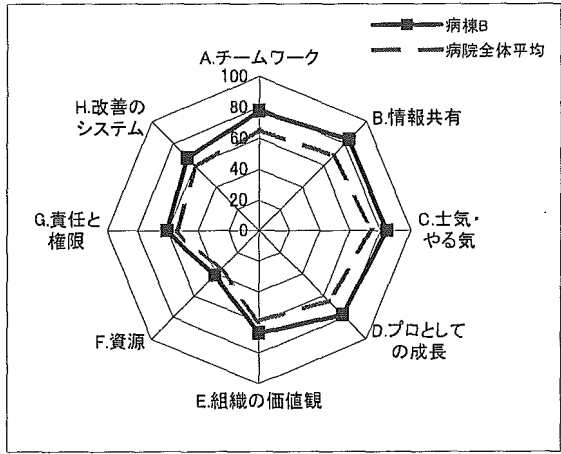
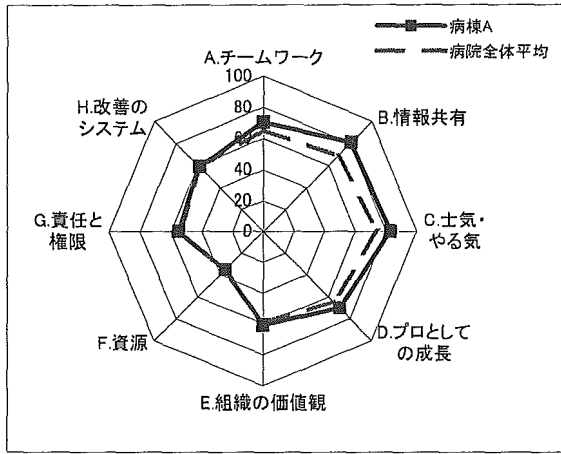

# ■ 病棟間比較

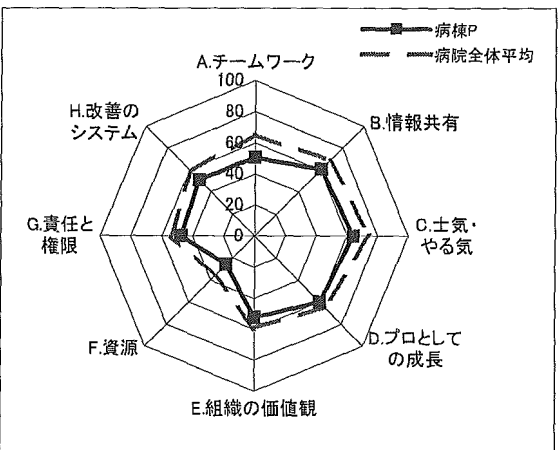
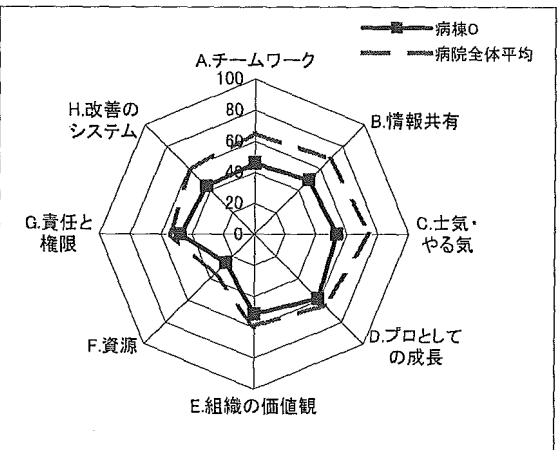
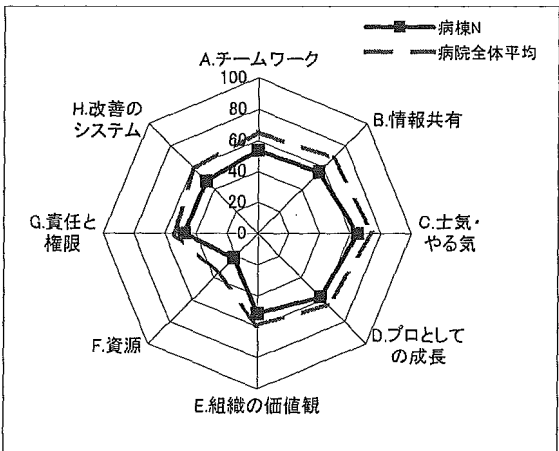
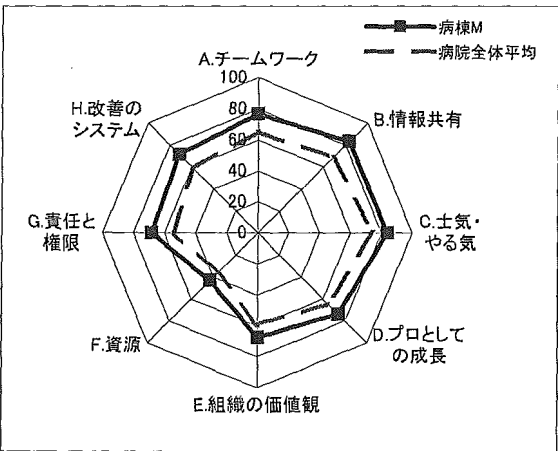
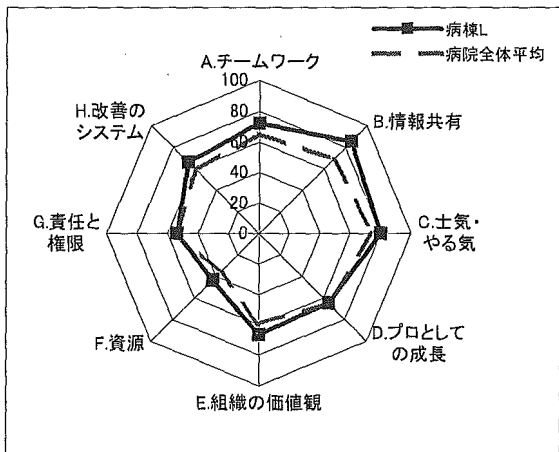
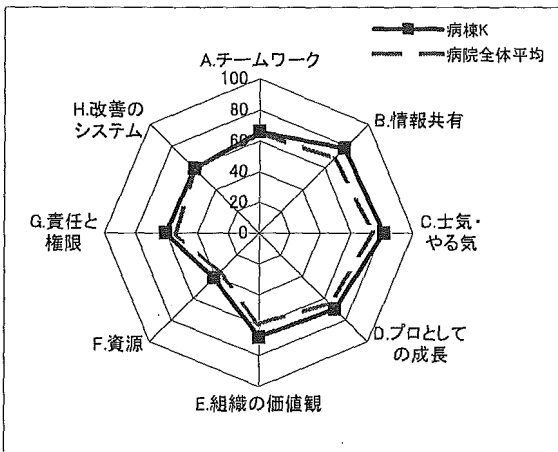
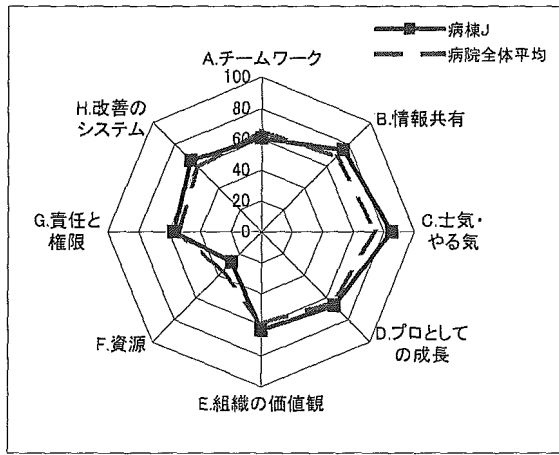
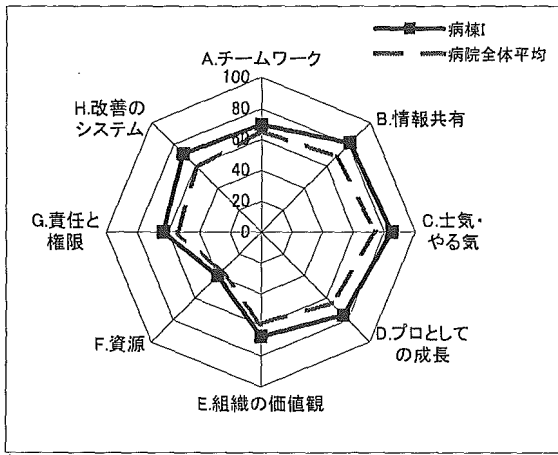

# ■ 病棟間比較

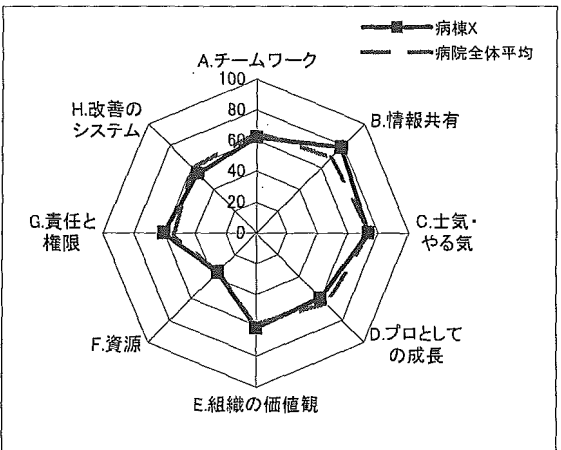
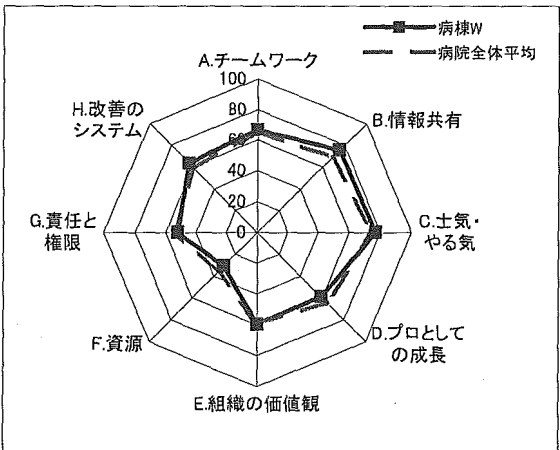
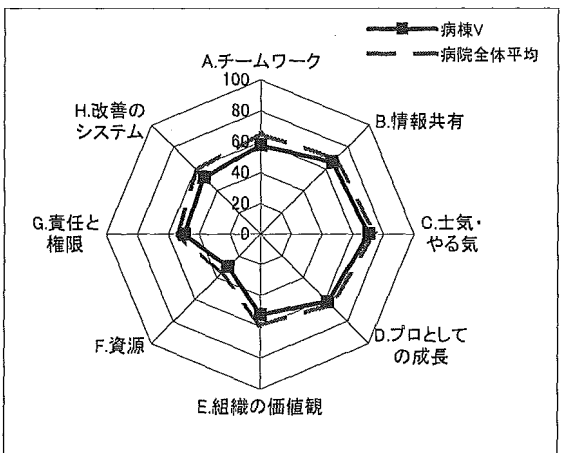
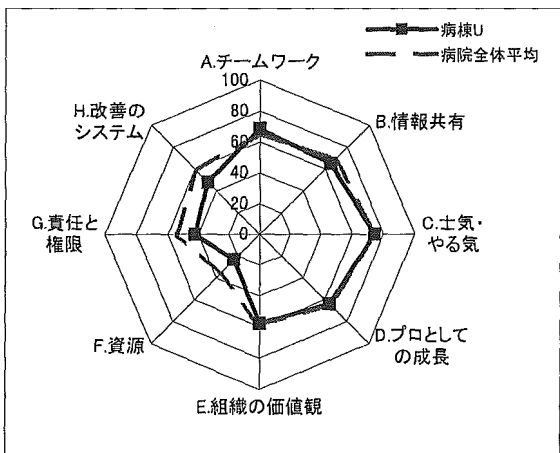
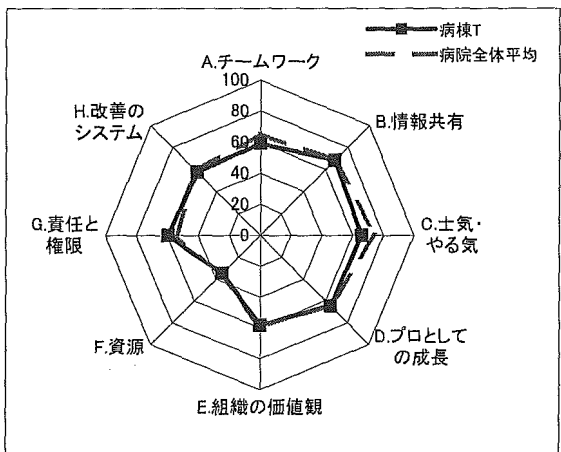
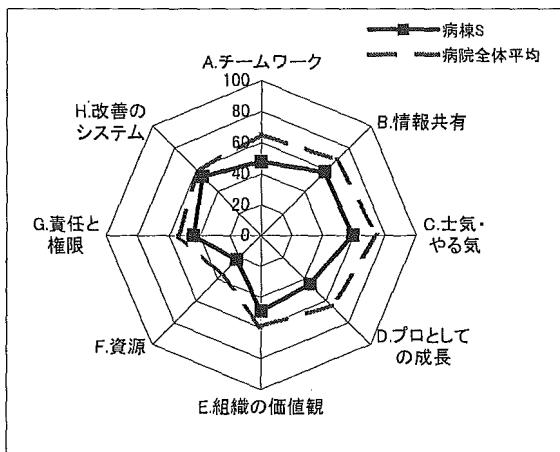
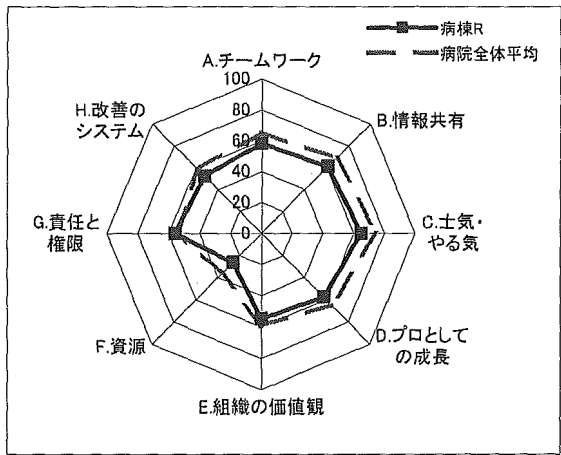
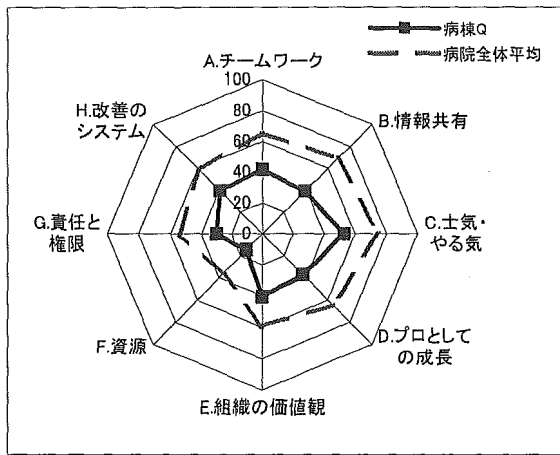

# ■ 病棟間比較

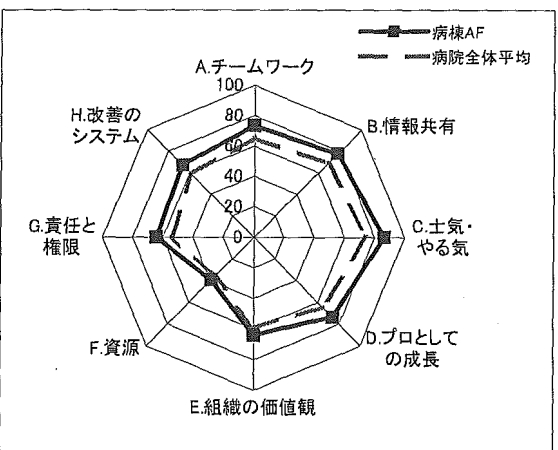
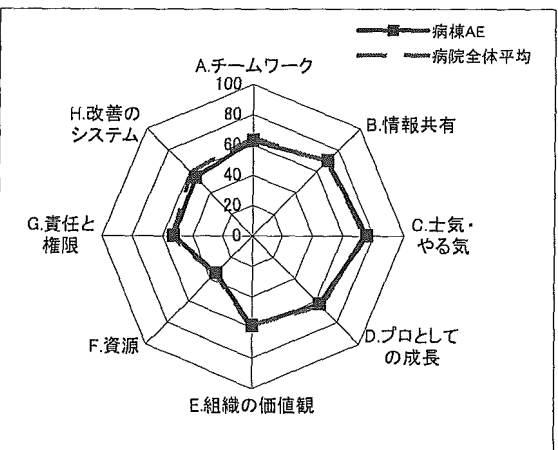
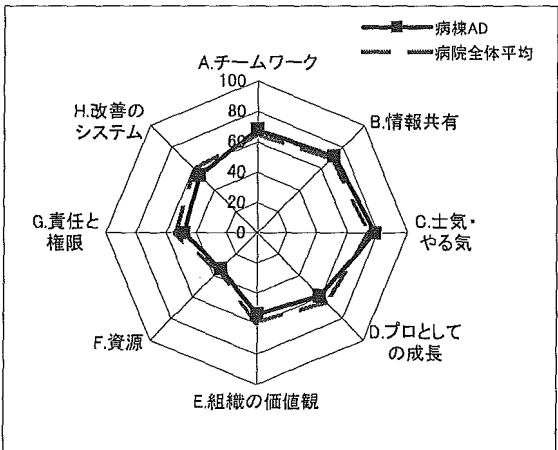
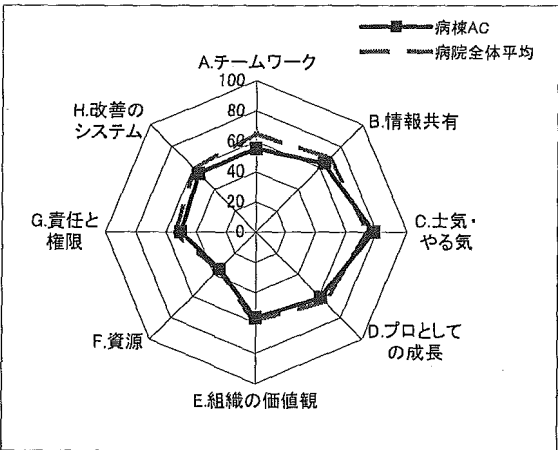
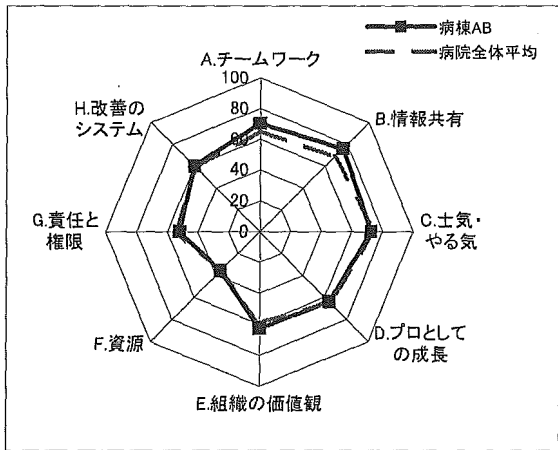
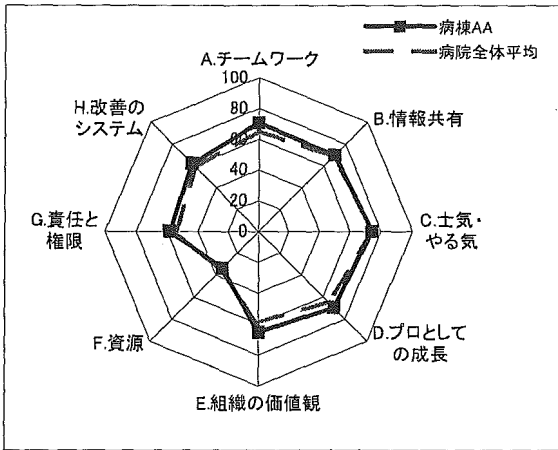
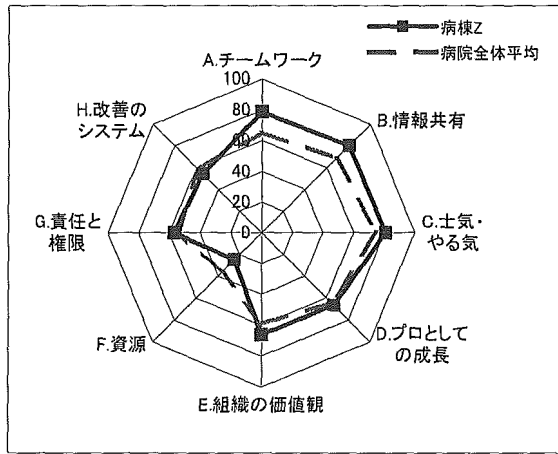
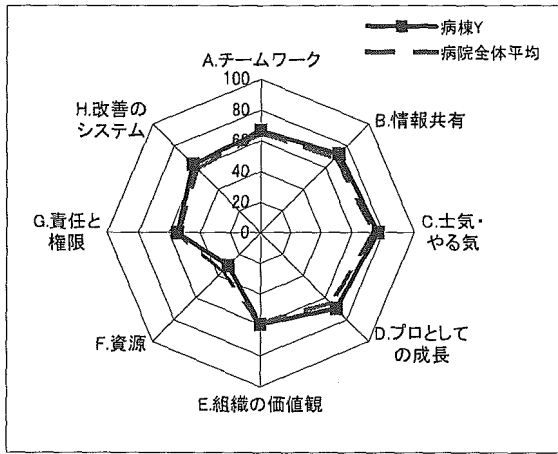

## ■ 病棟間比較

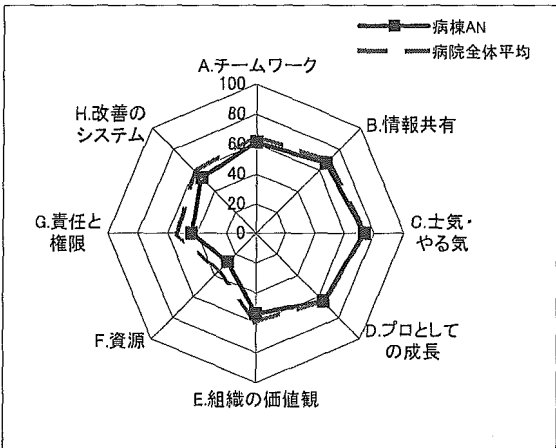
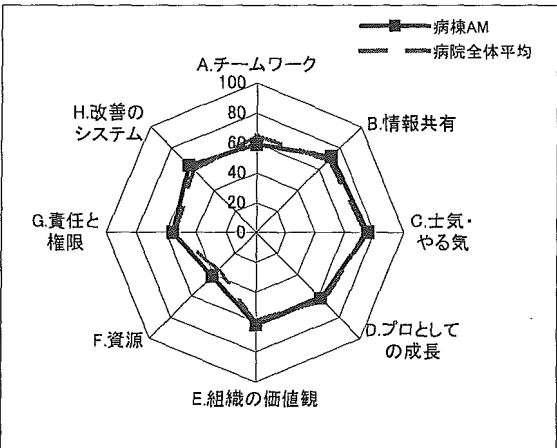
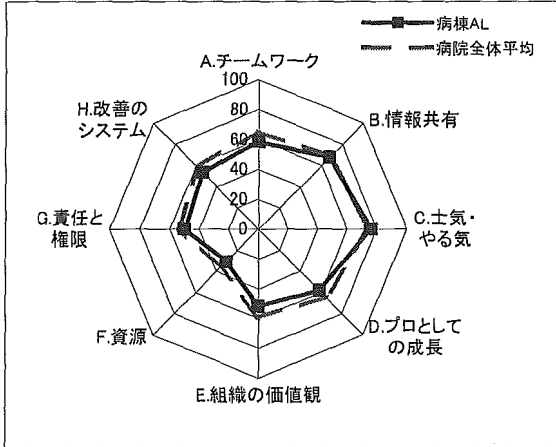
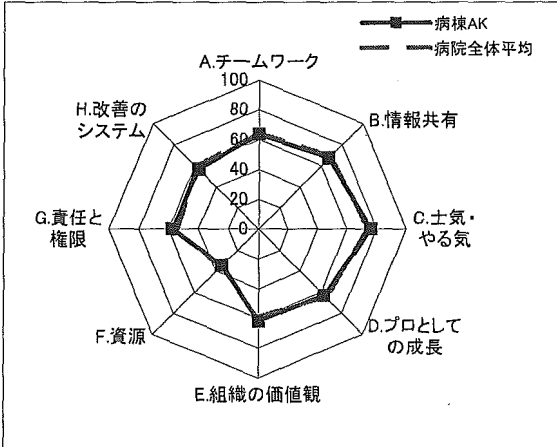
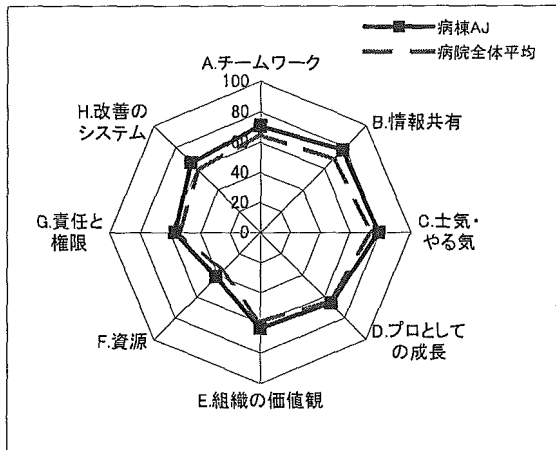
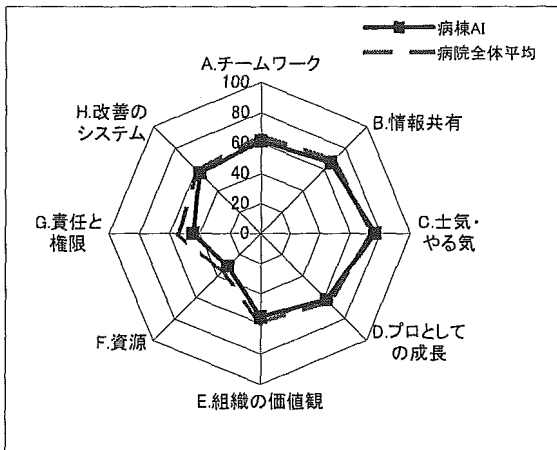
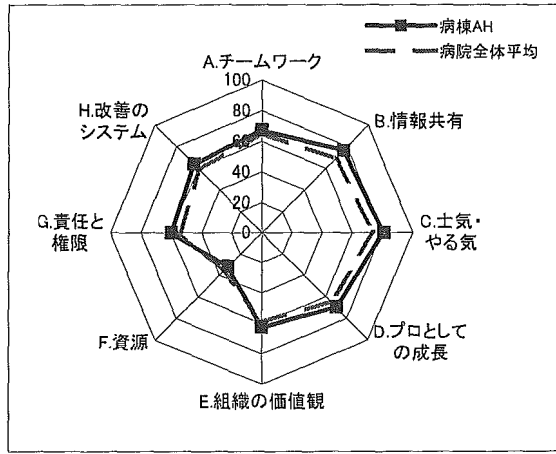
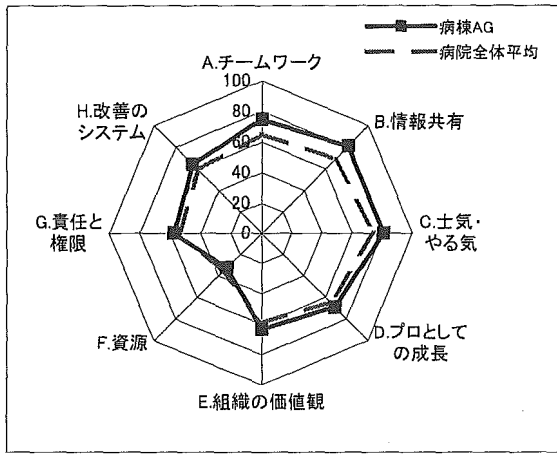



# ■ 病棟間比較

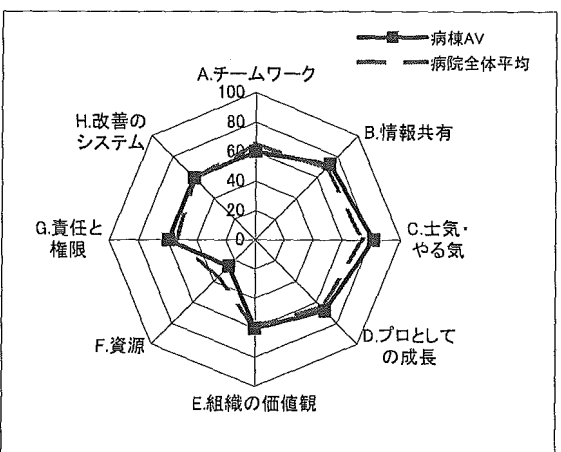
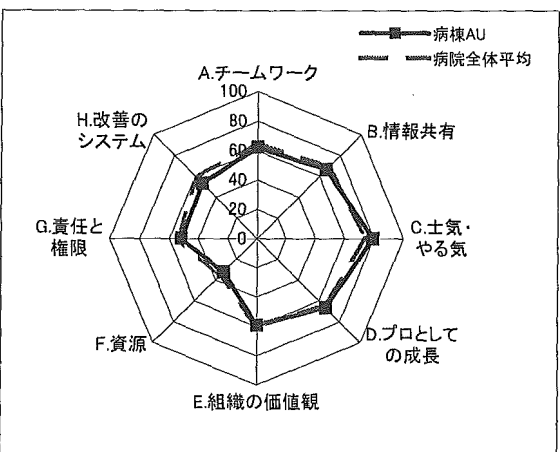
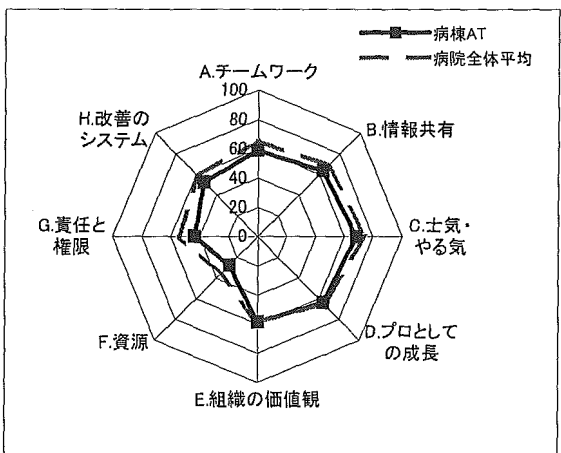
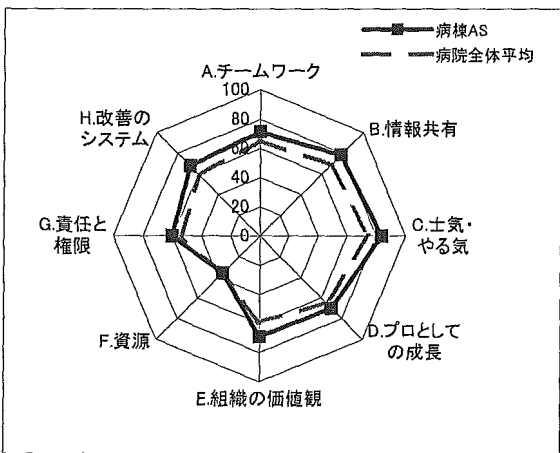
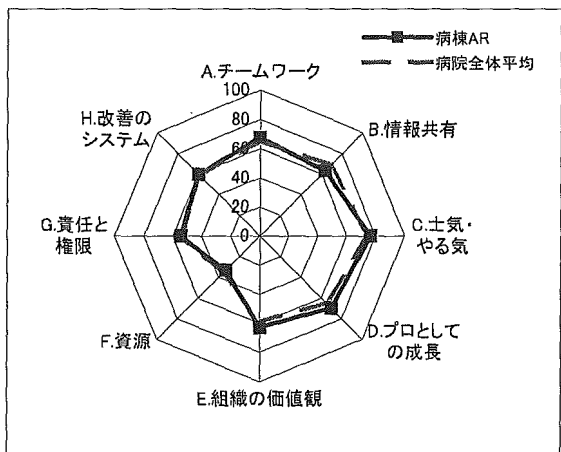
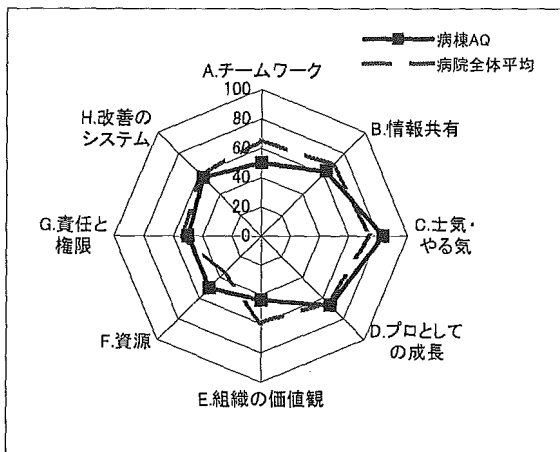
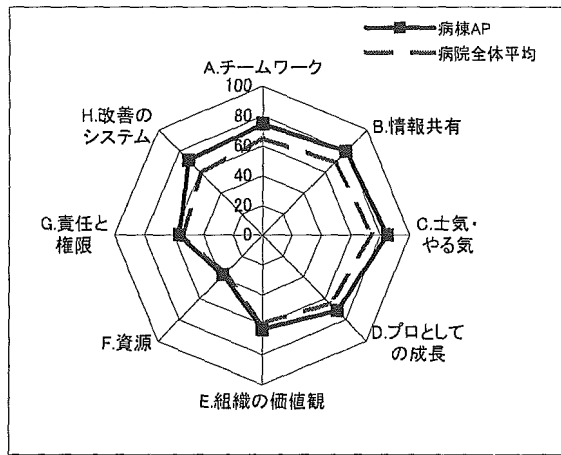
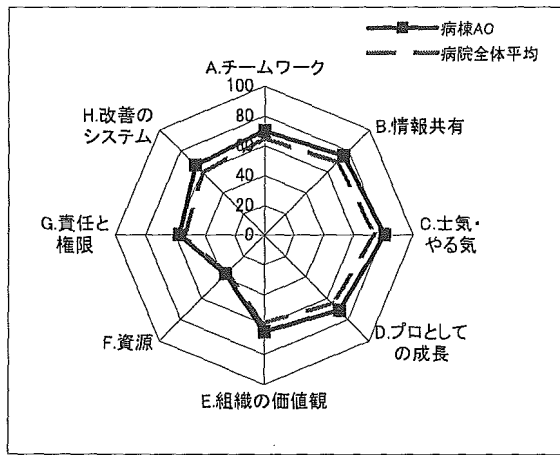

# 病棟間比較

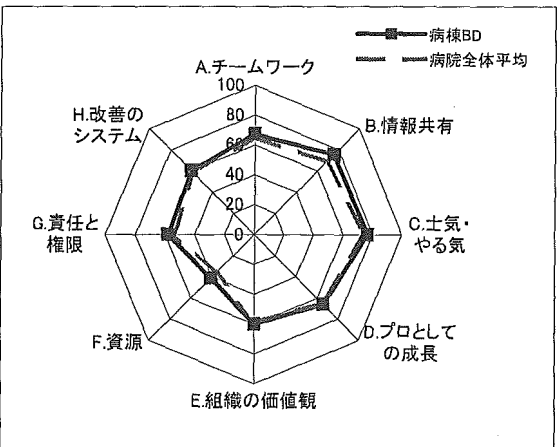
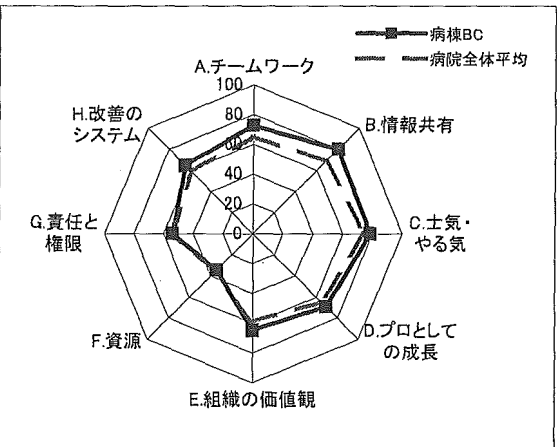
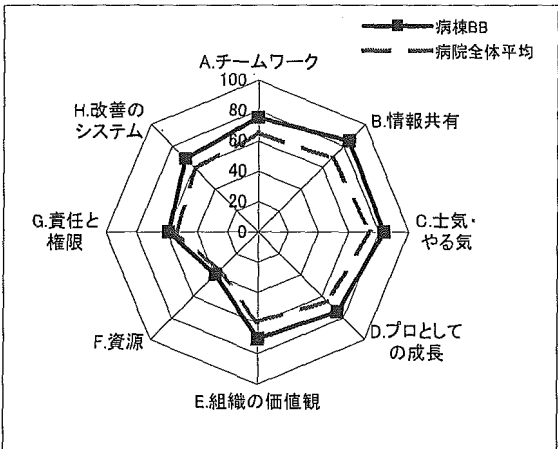
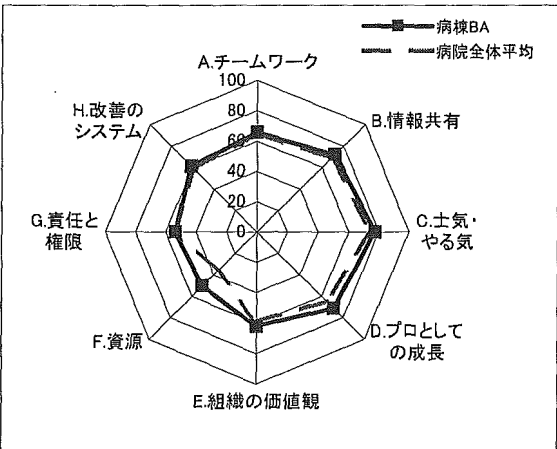
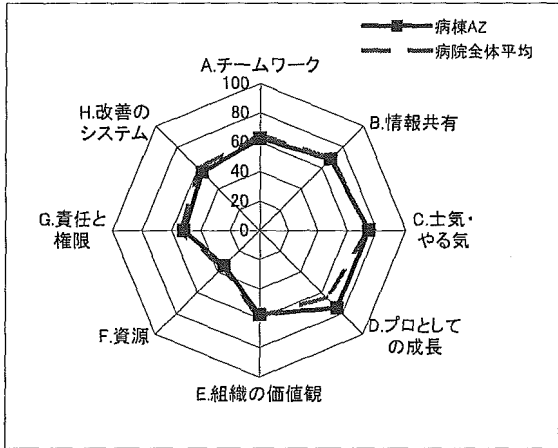
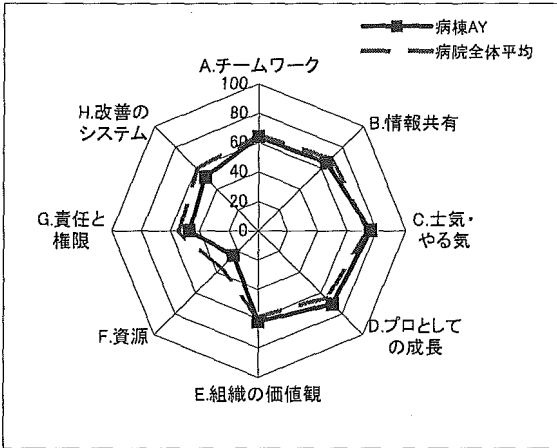
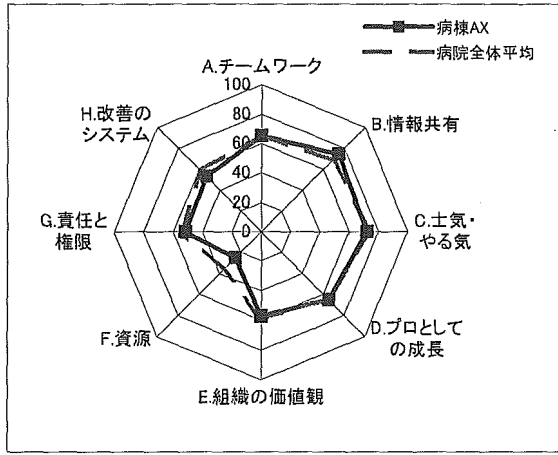
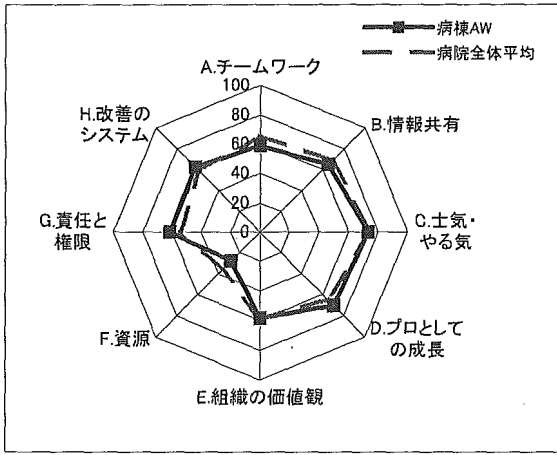

# ■ 病棟間比較

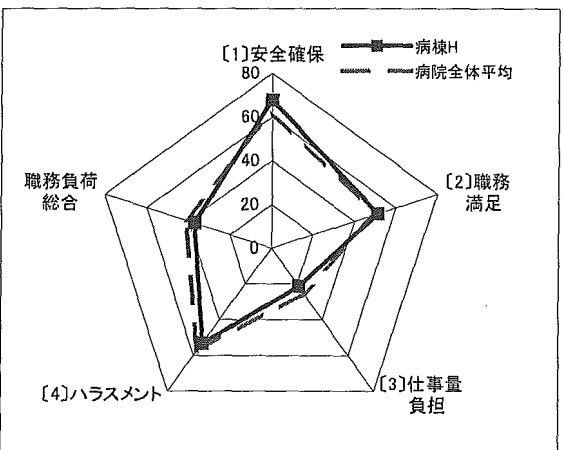
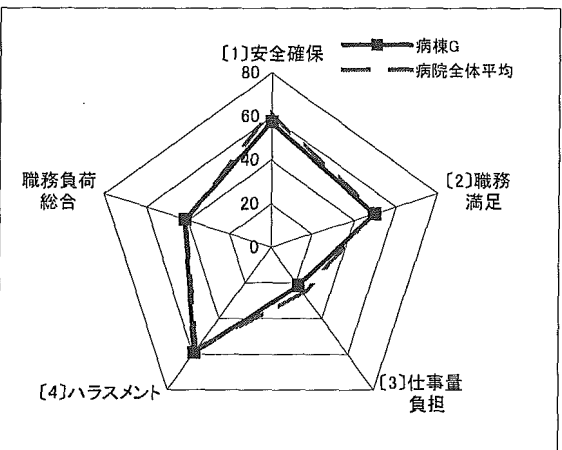
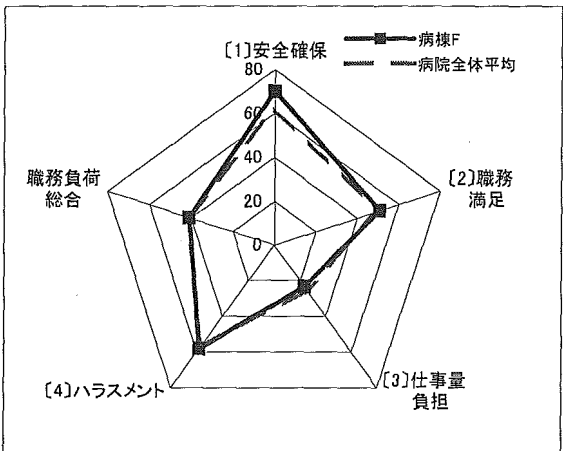
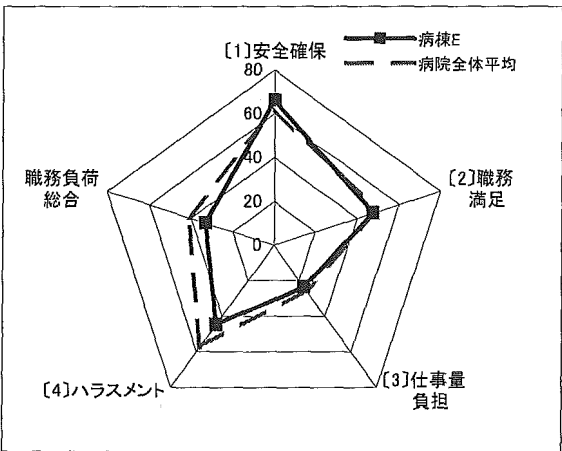
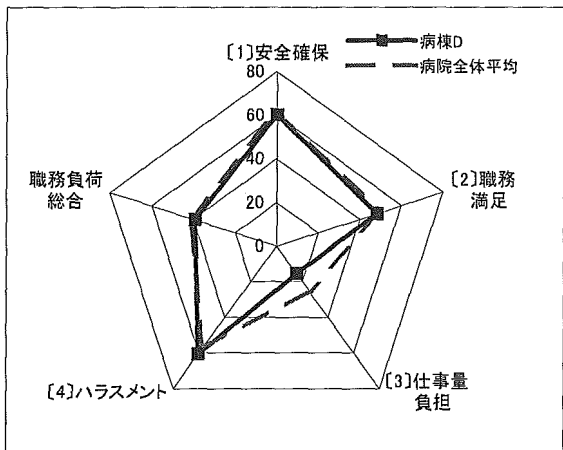
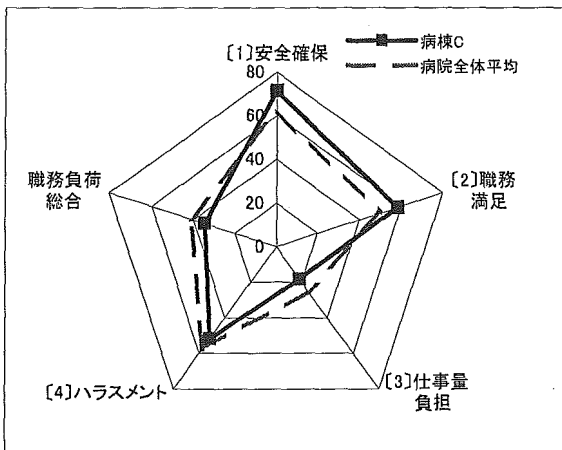
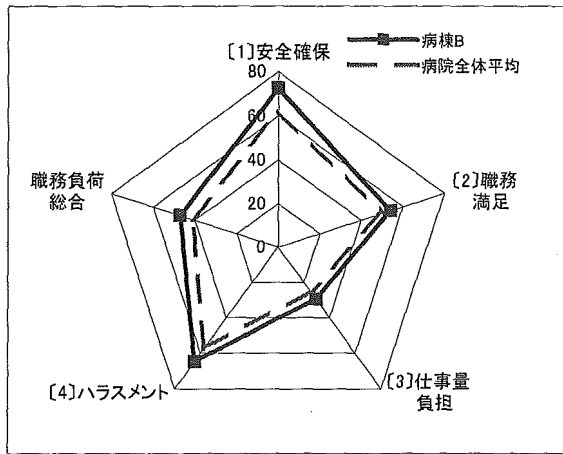
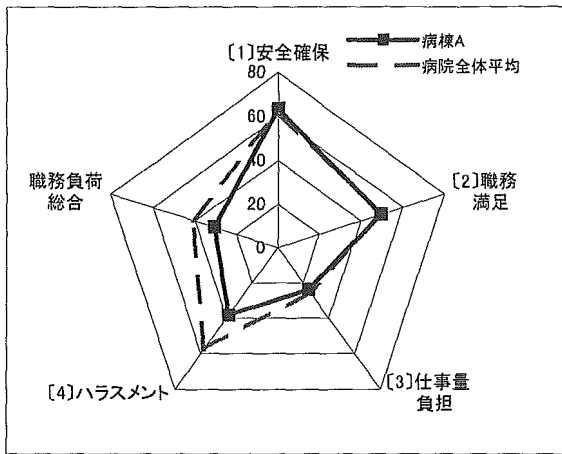

# ■ 病棟間比較

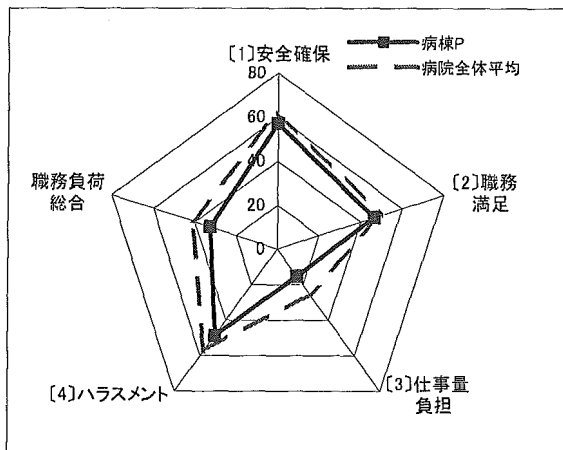
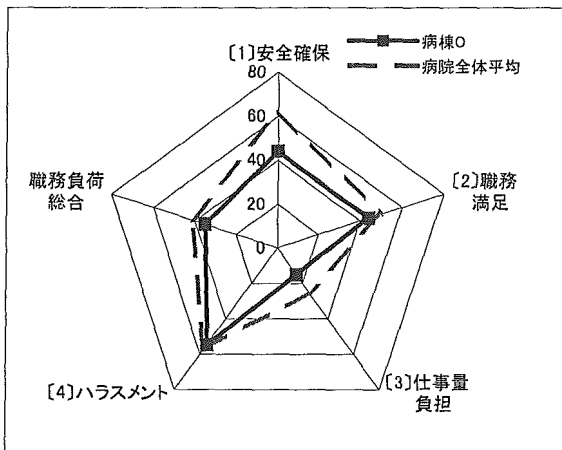
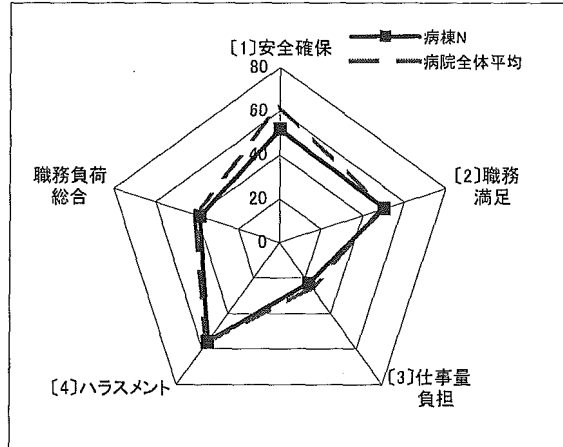
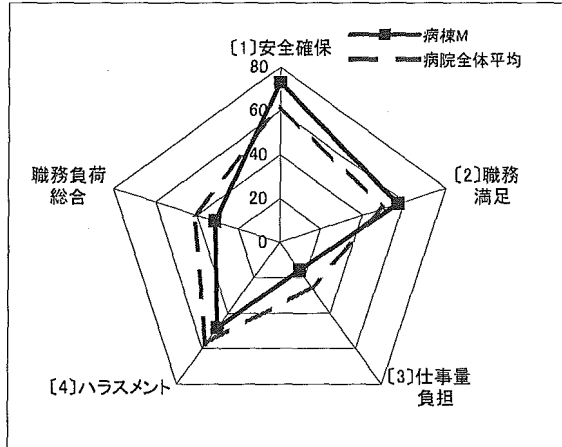
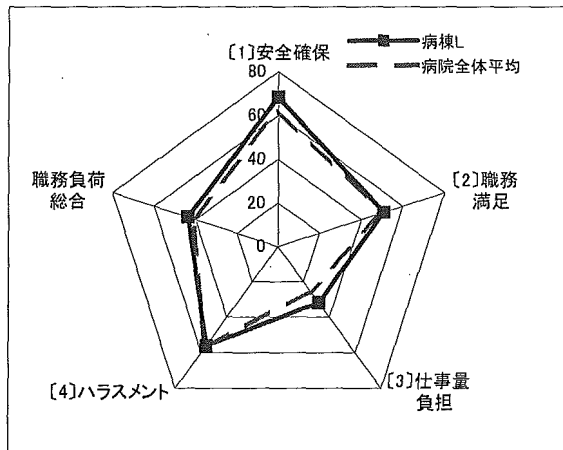
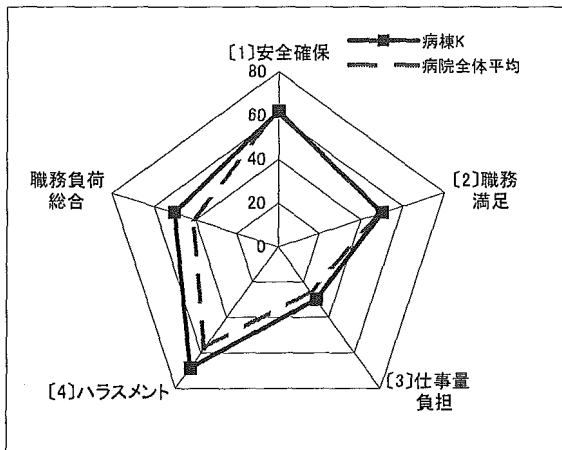
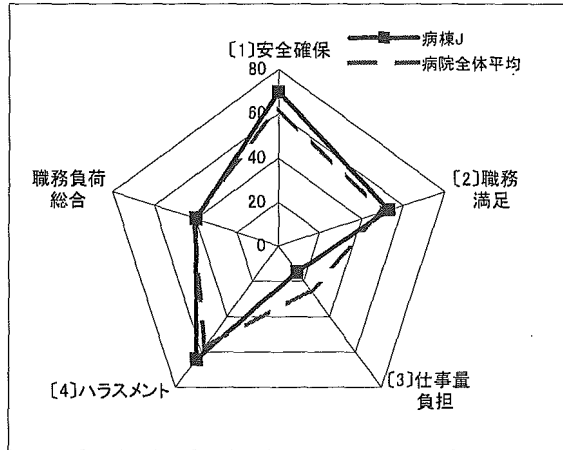
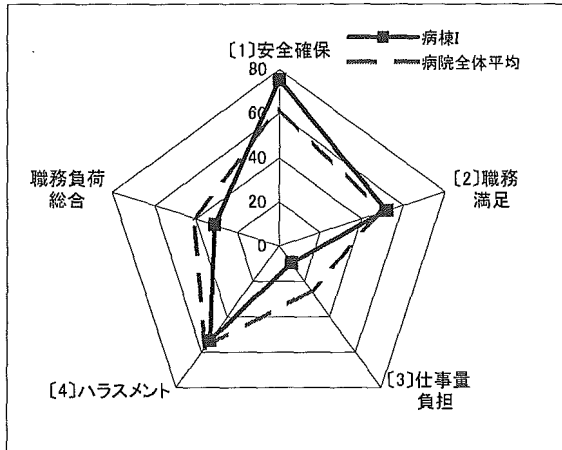

# ■ 病棟間比較

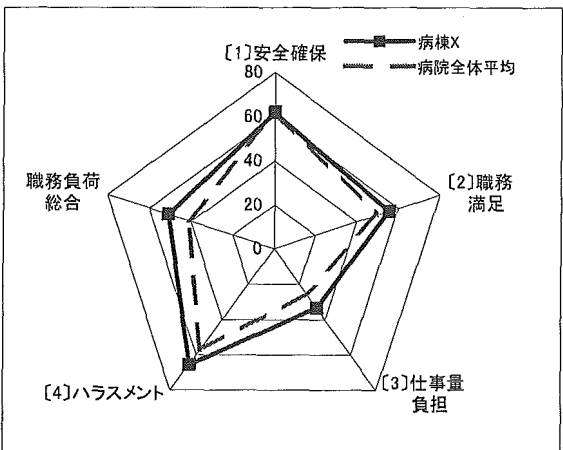
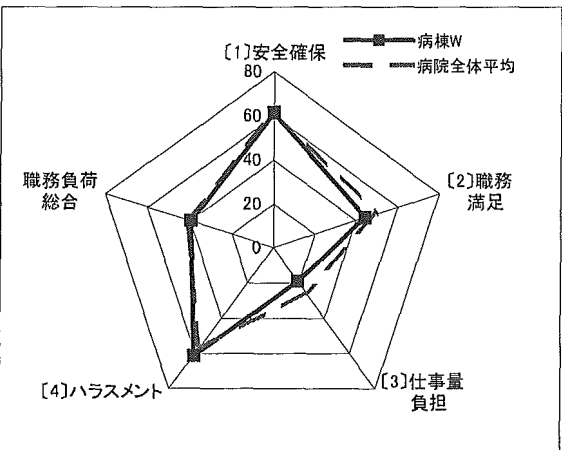
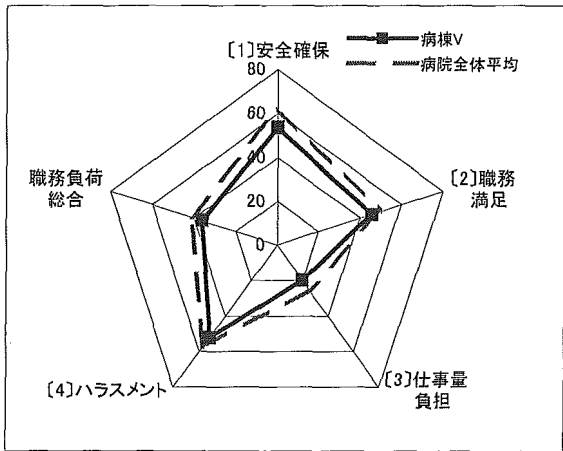
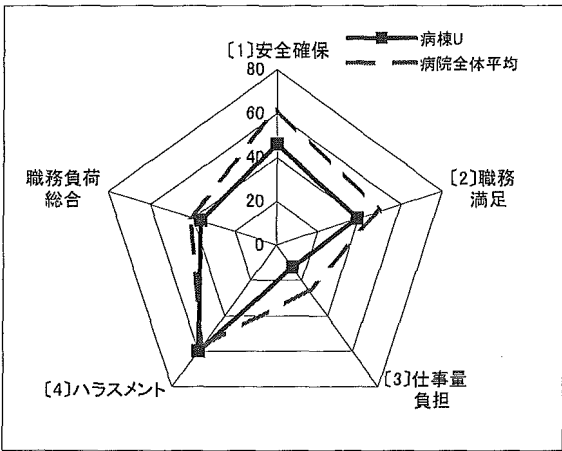
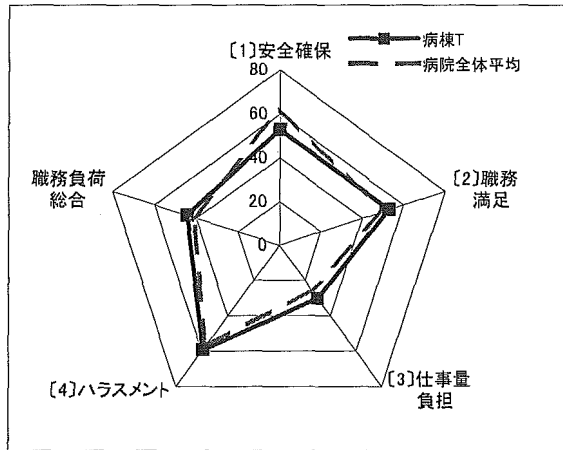
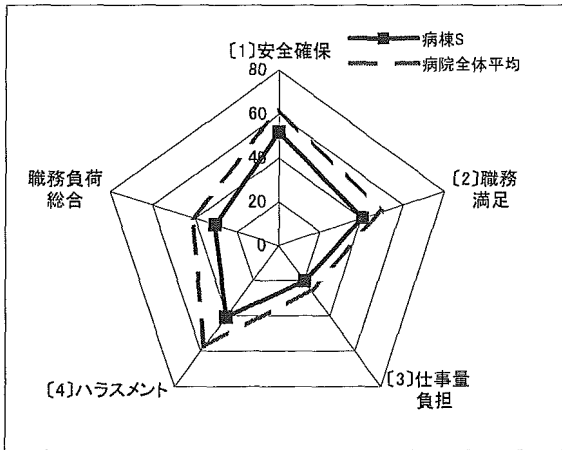
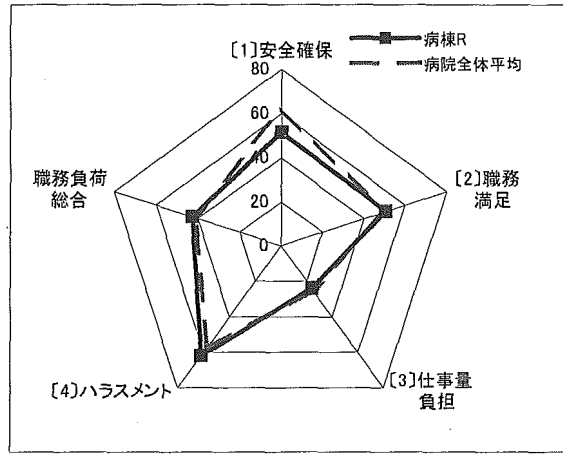
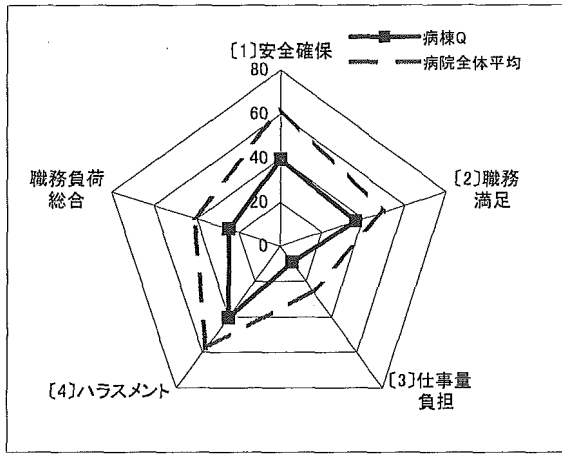

# ■ 病棟間比較

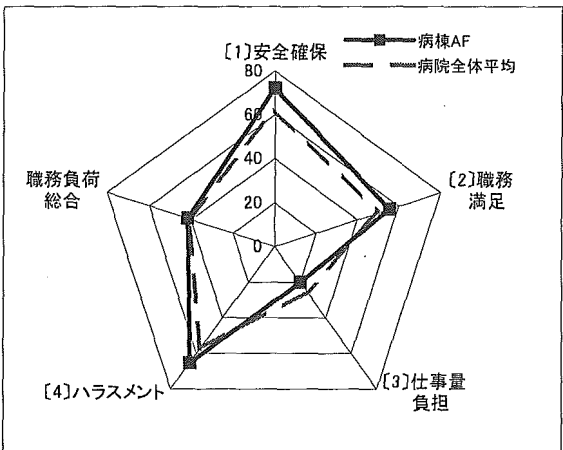
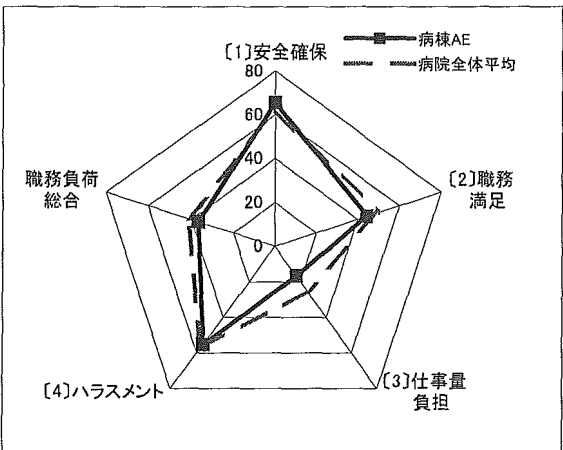
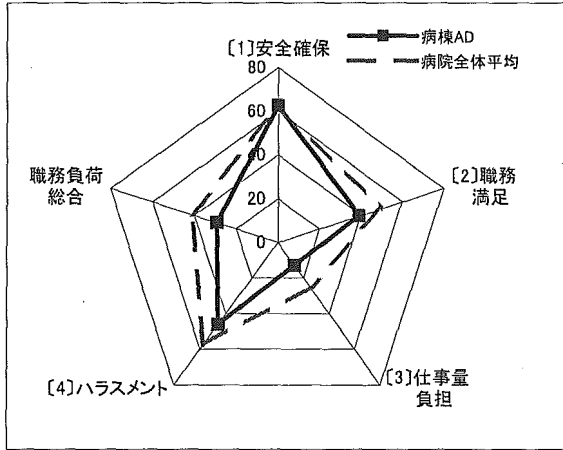
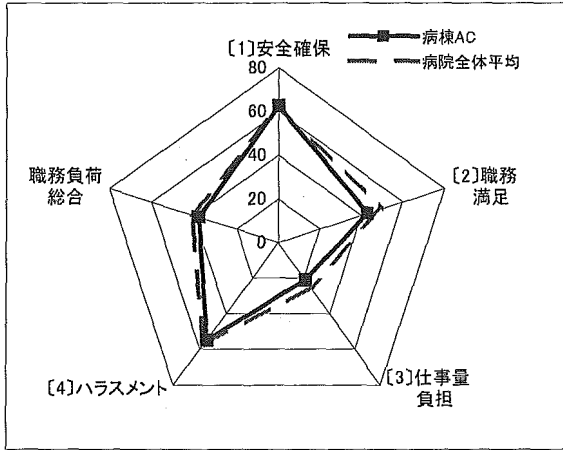
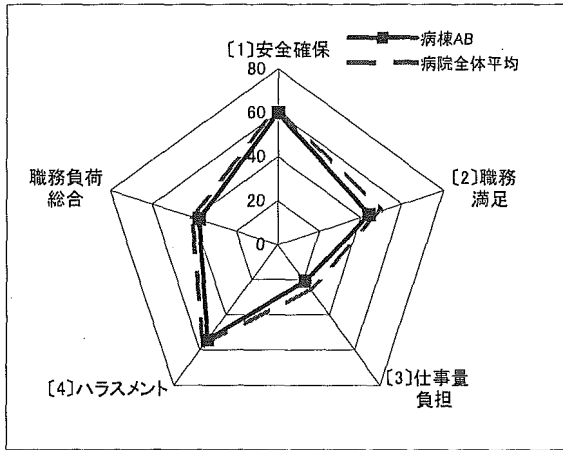
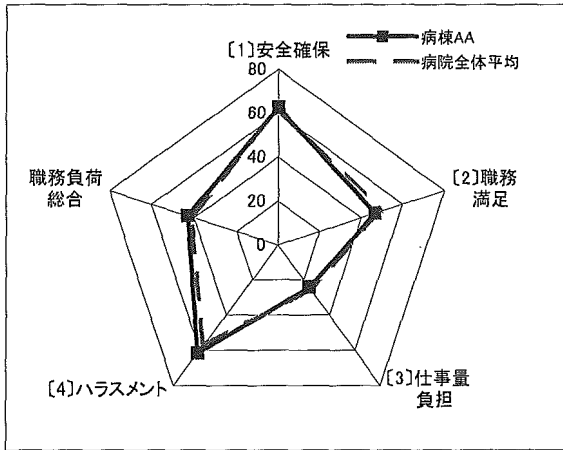
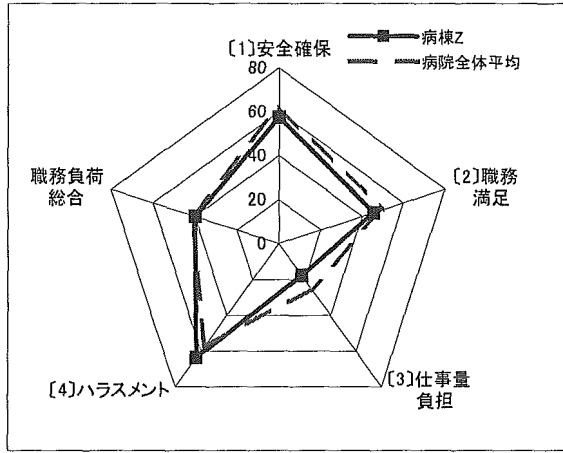
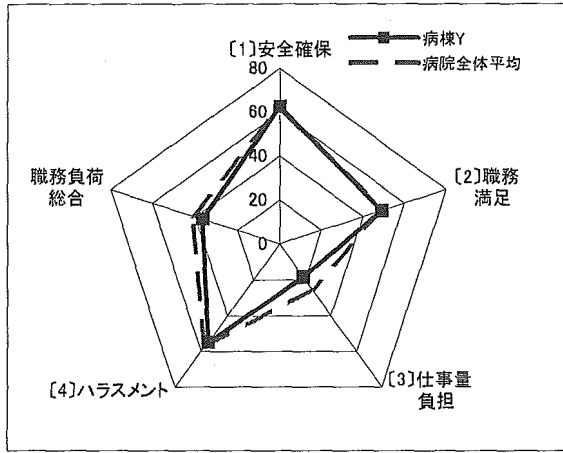

# ■ 病棟間比較

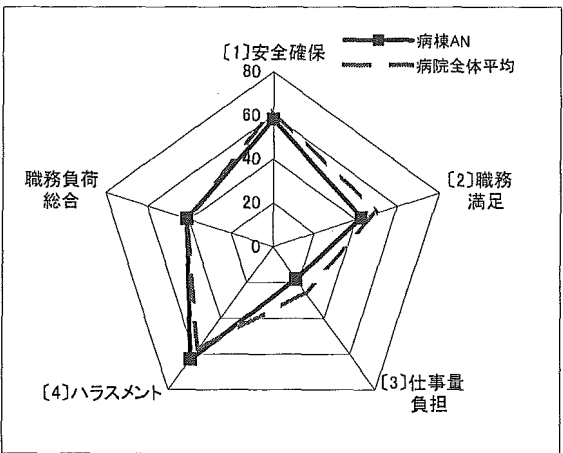
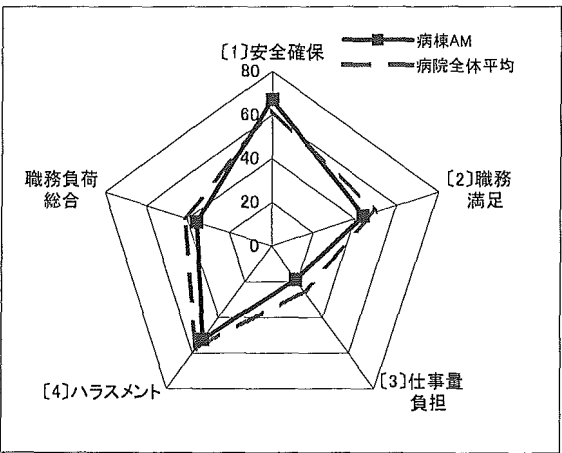
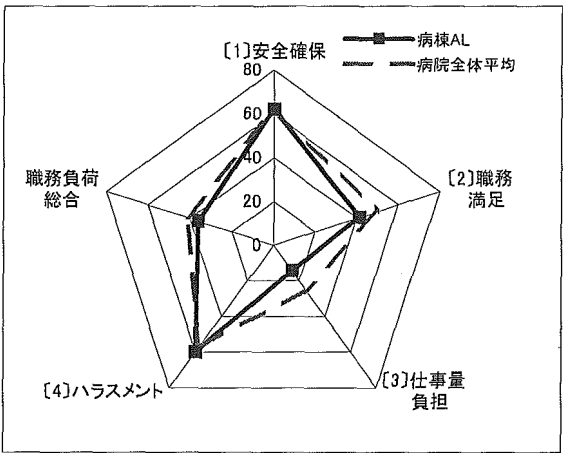
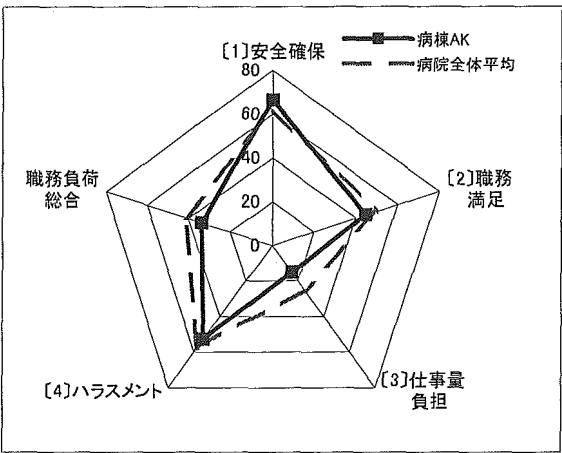
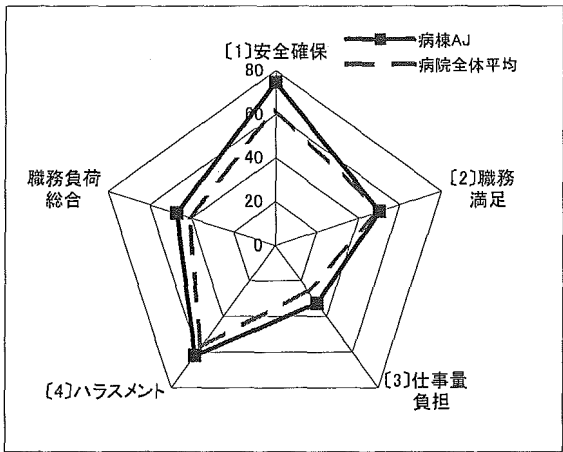
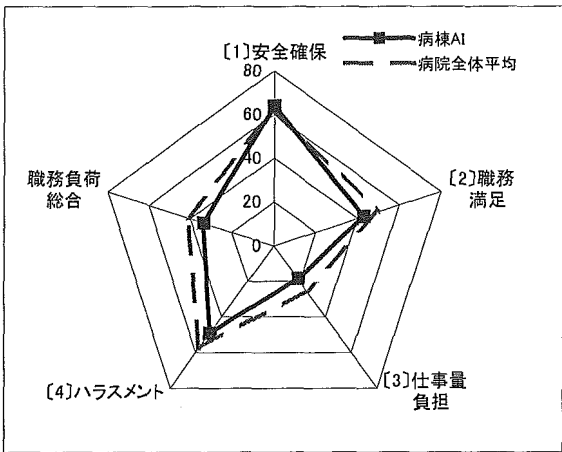
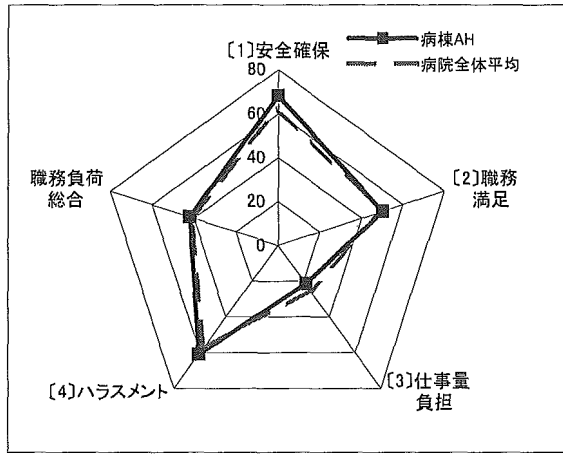
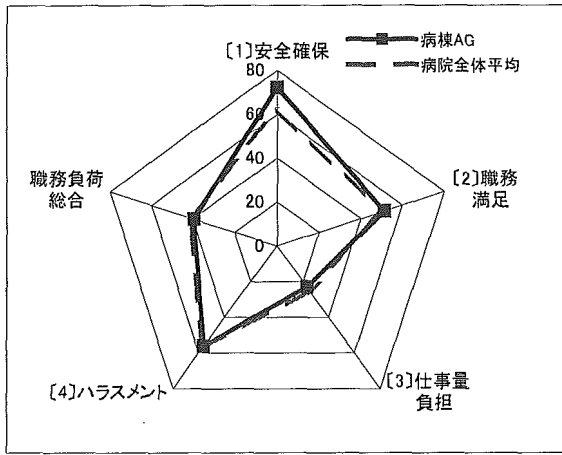

# ■ 病棟間比較

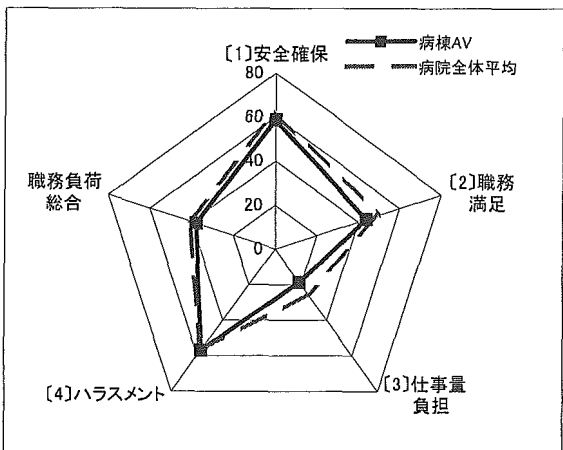
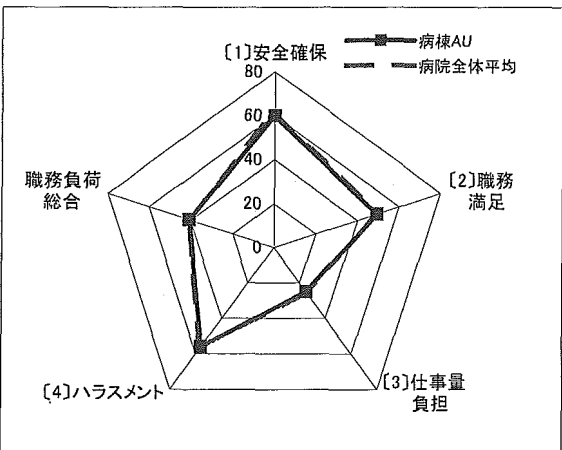
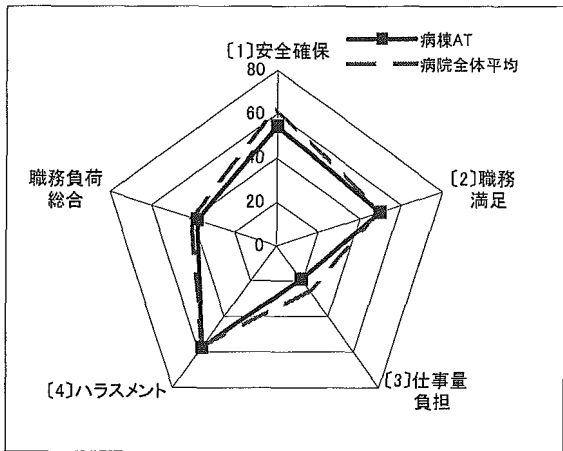
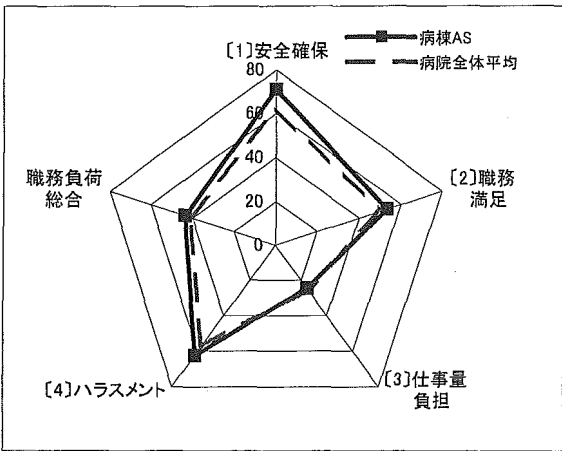
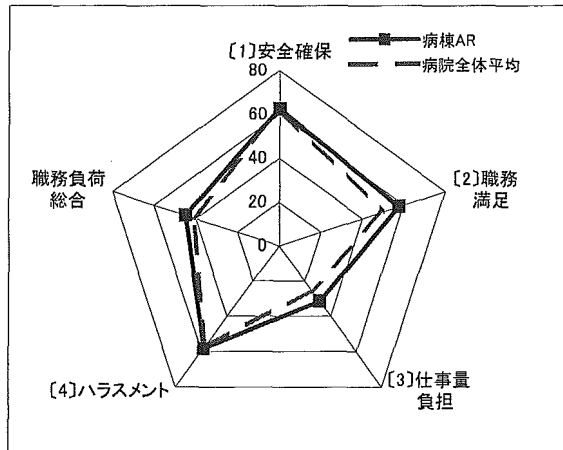
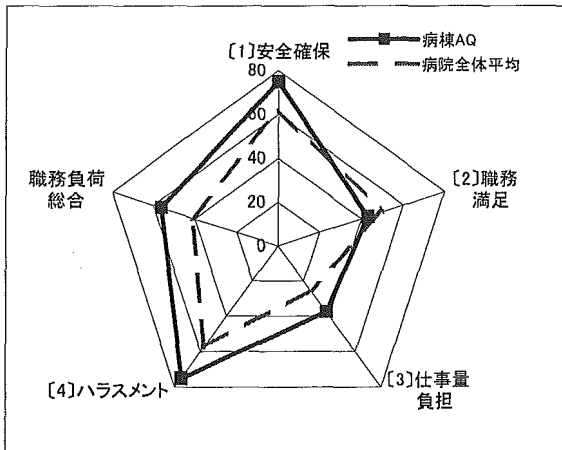
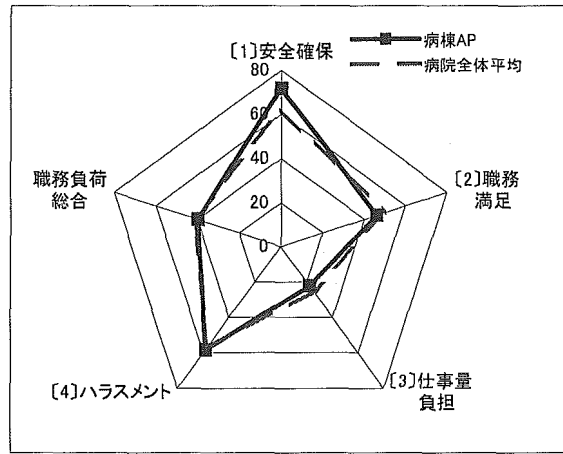
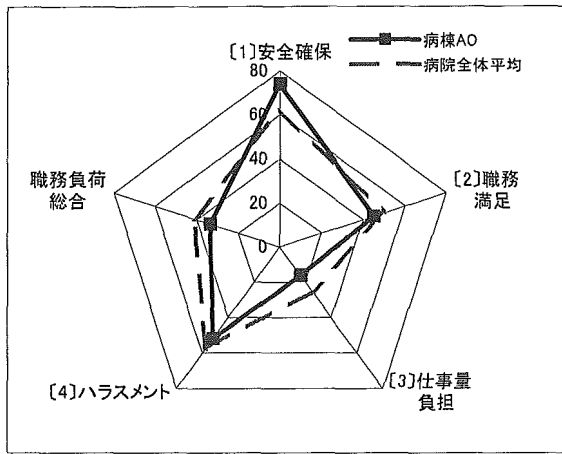



# ■ 病棟間比較

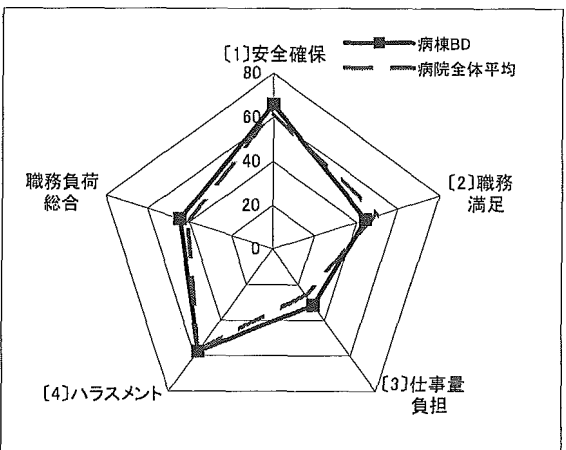
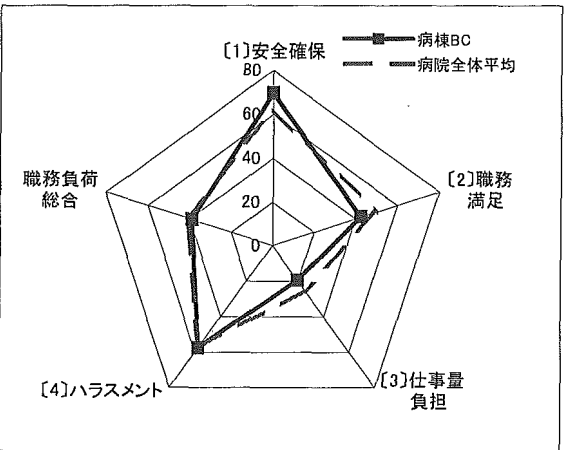
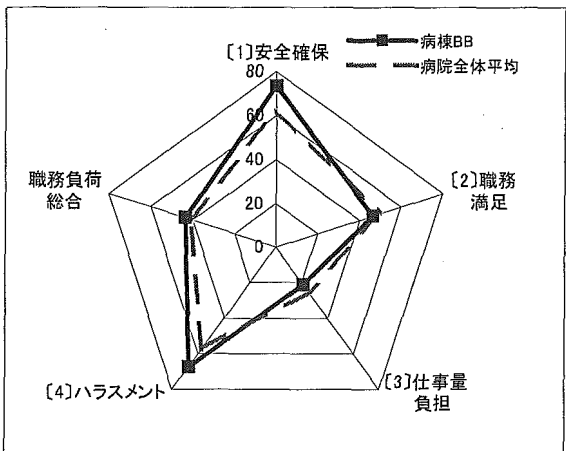
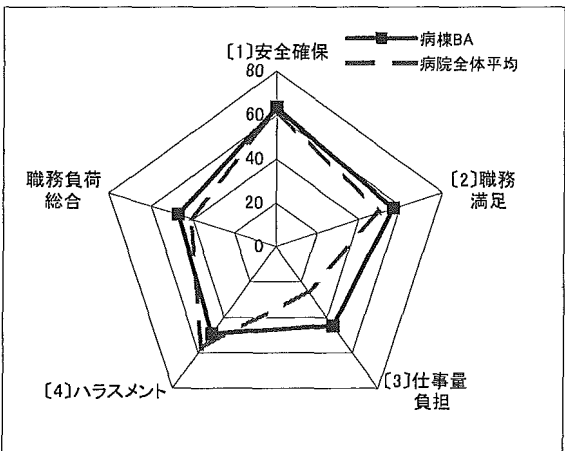
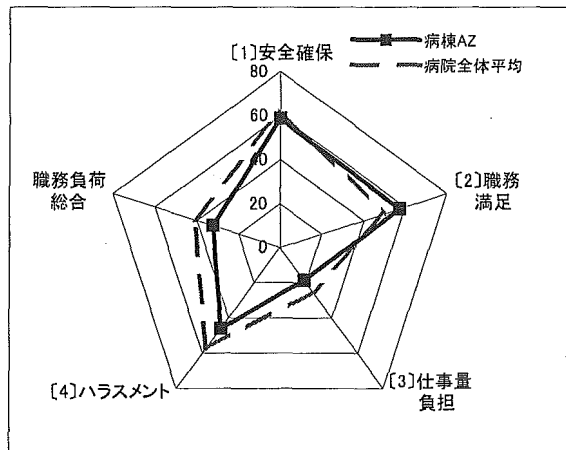
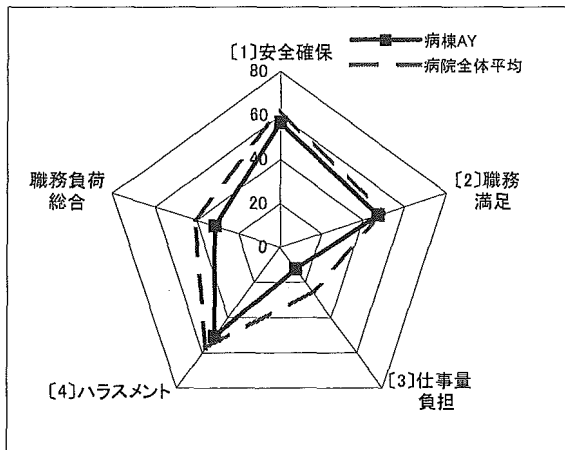
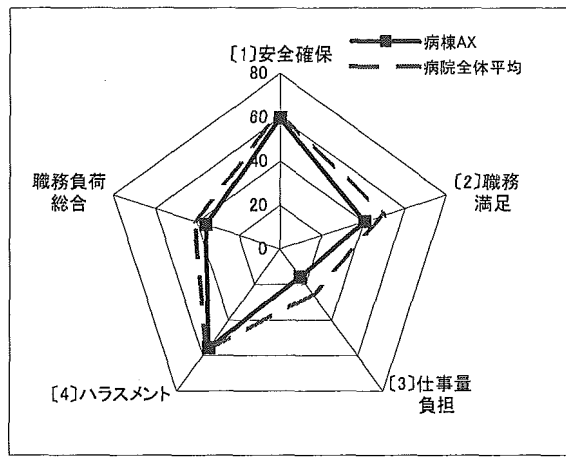
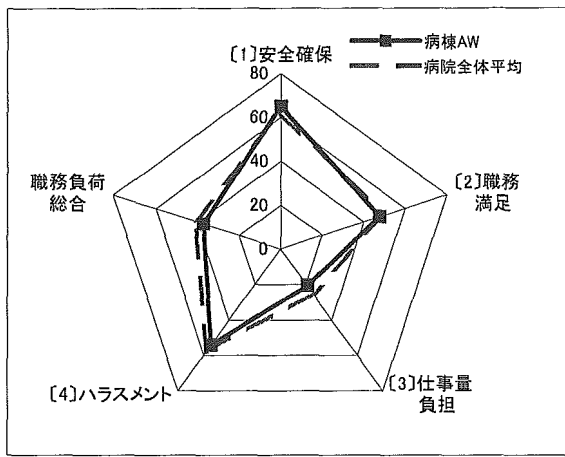

# ■ 看護系部署間比較

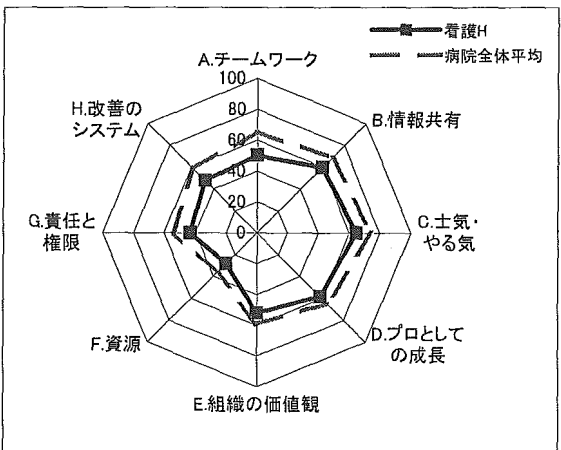
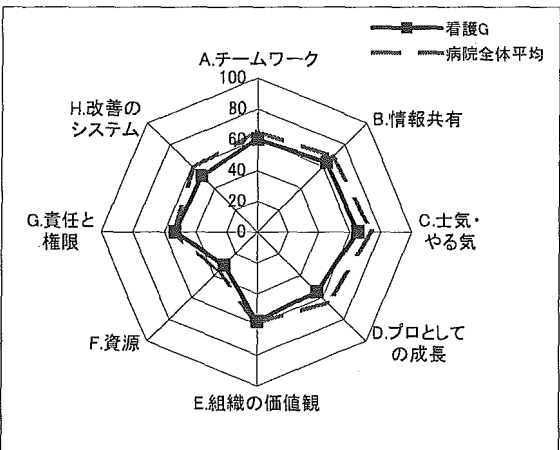
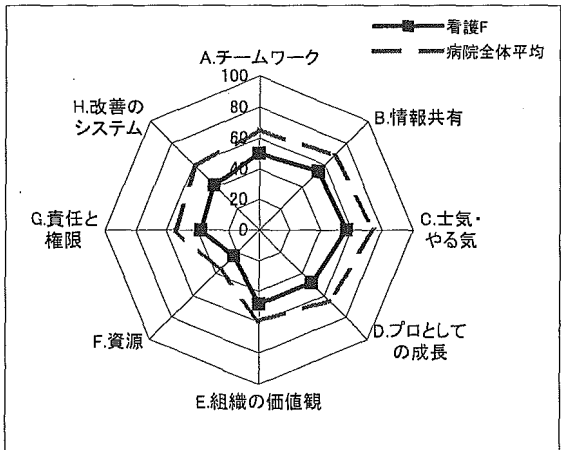
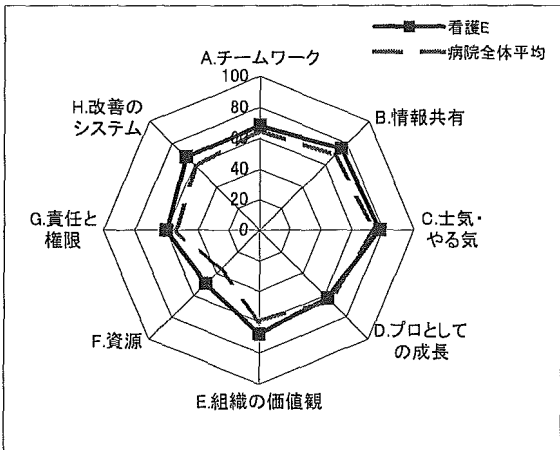
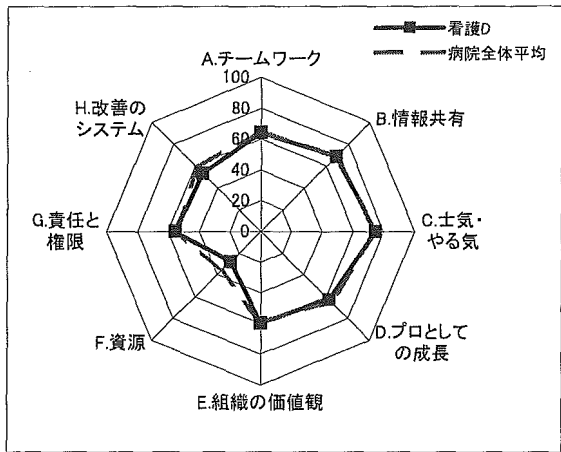
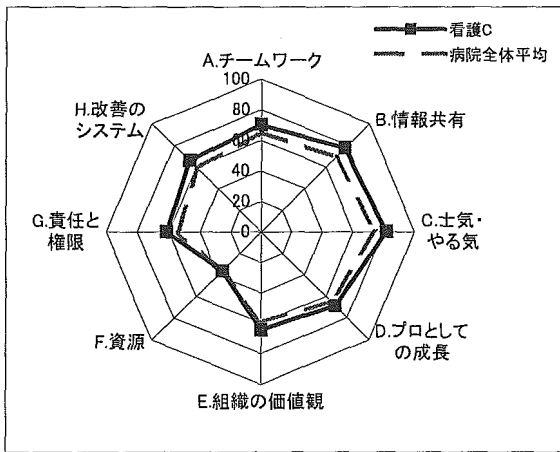
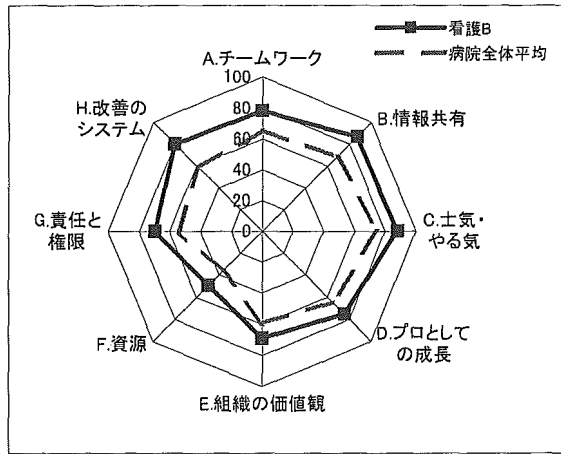
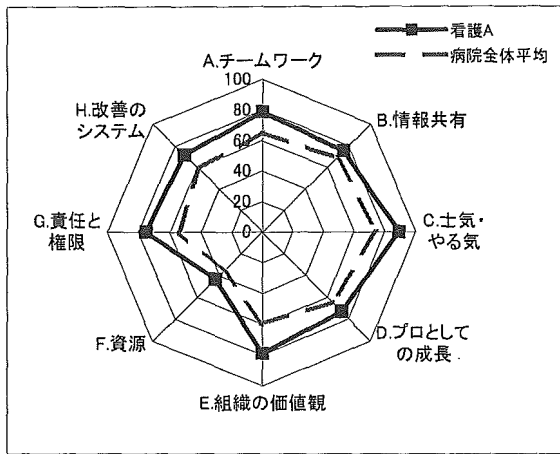

# ■ 看護系部署間比較

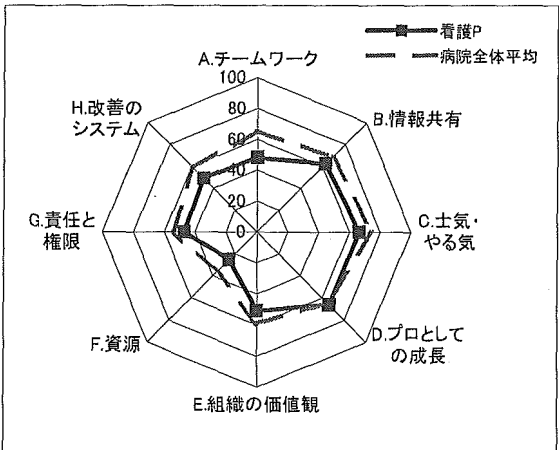
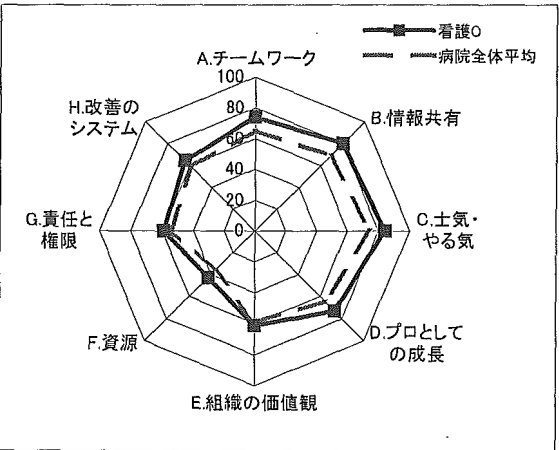
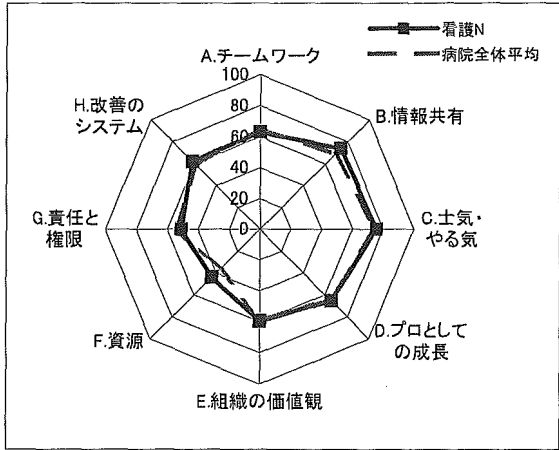
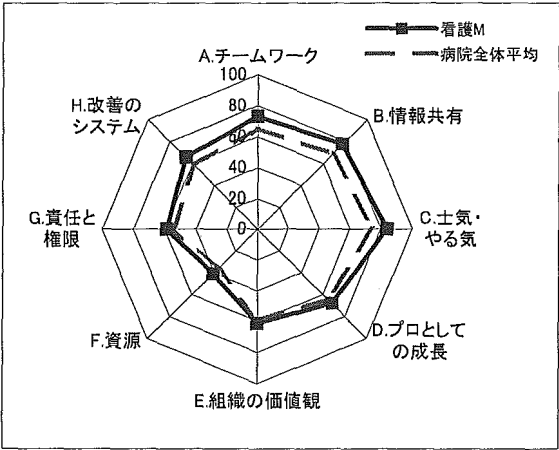
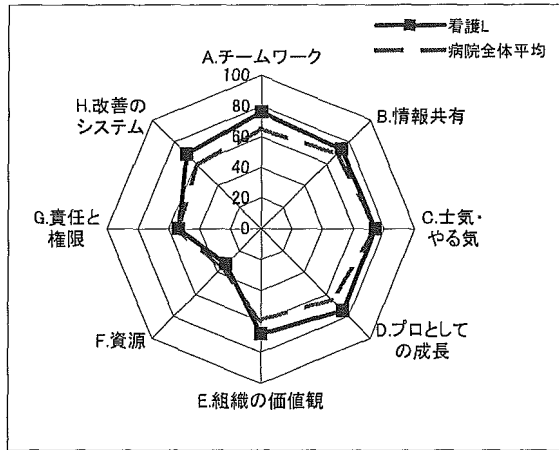
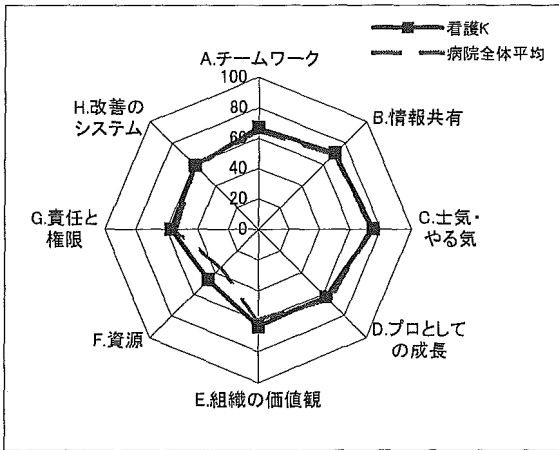
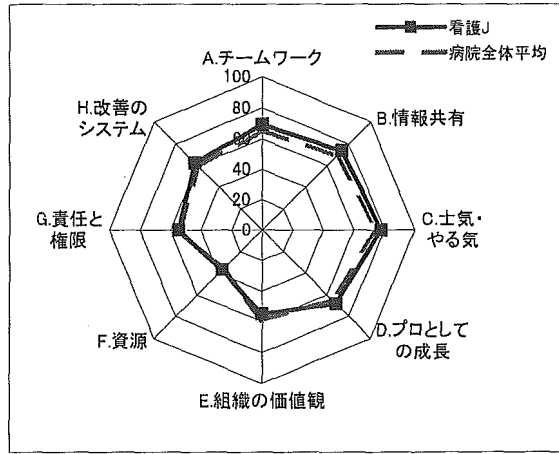
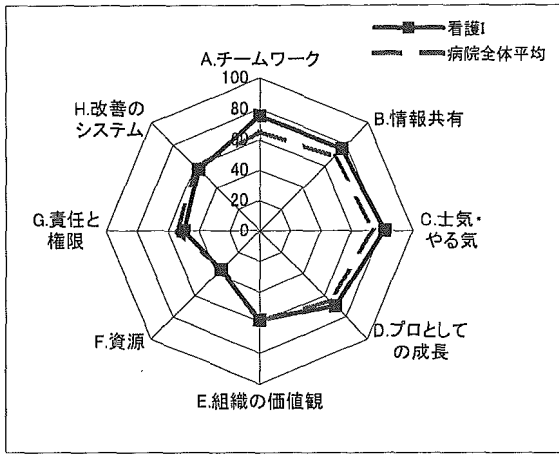

# ■ 看護系部署間比較

