

診療科間比較

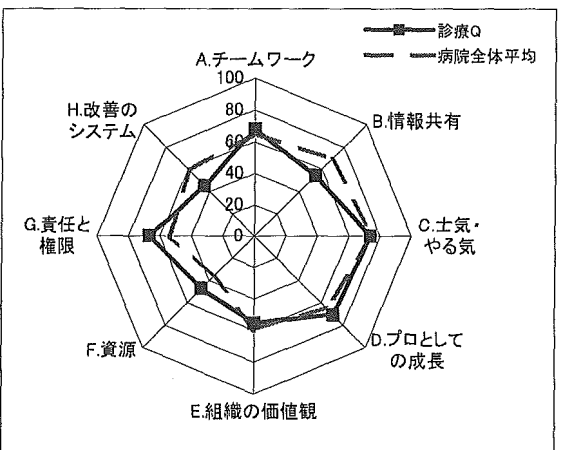

診療科間比較

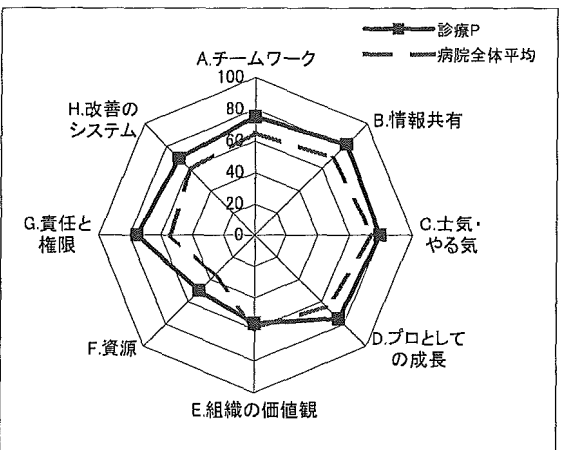
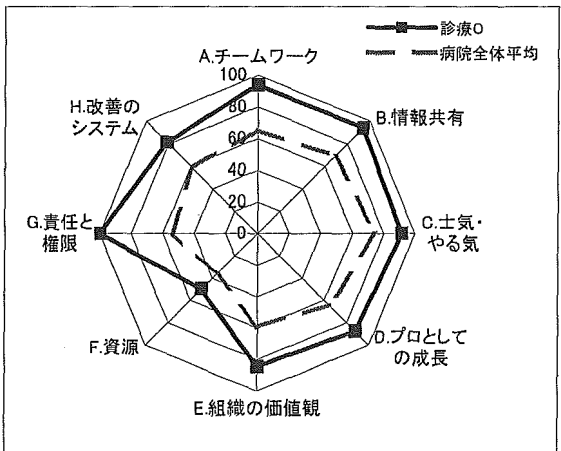
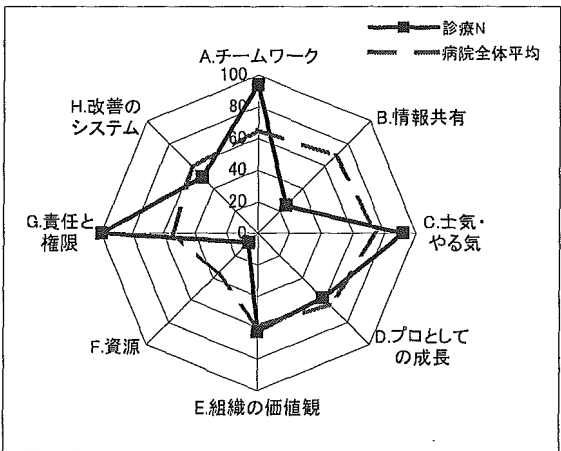
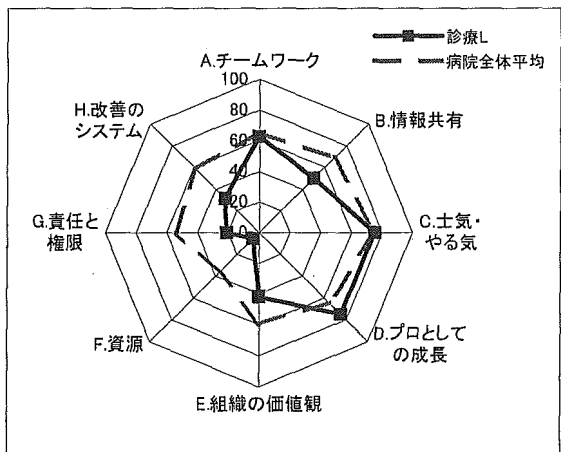
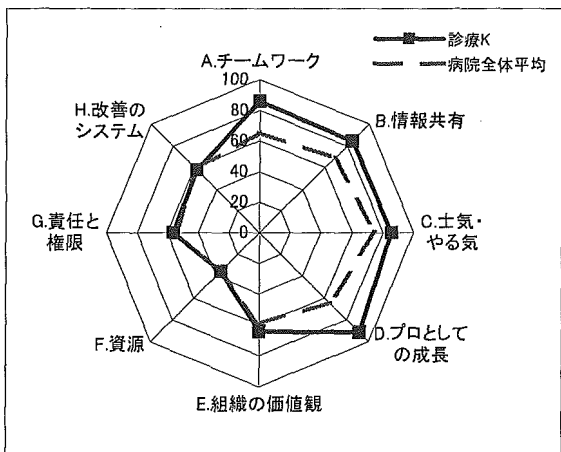
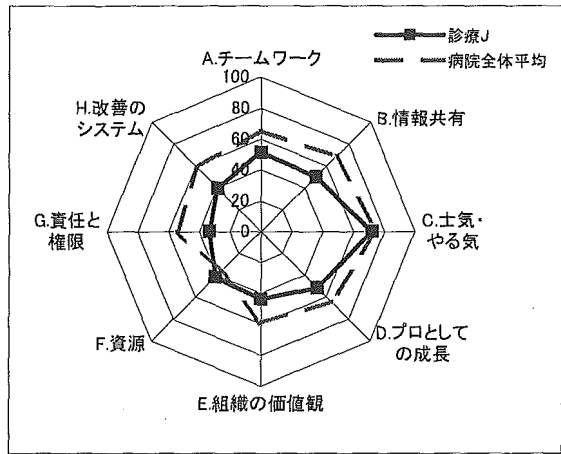
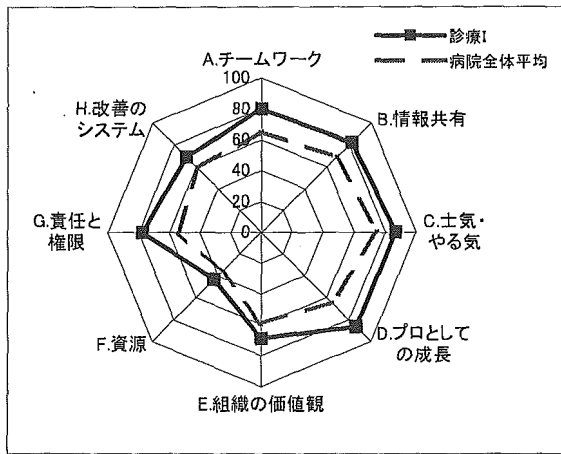
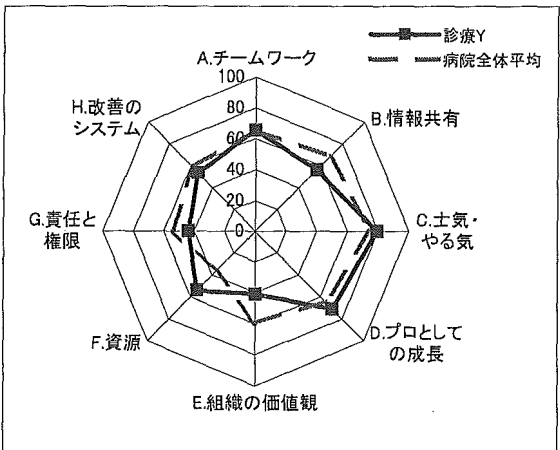
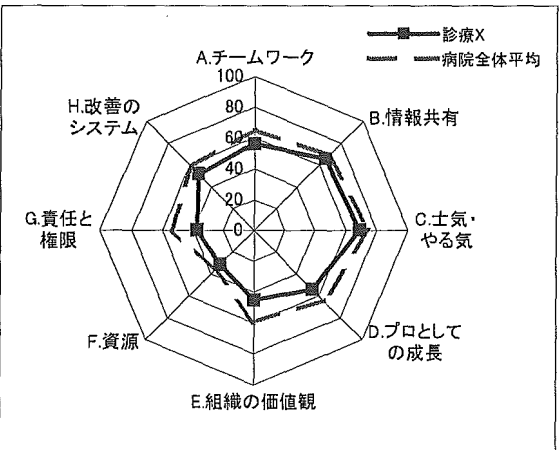
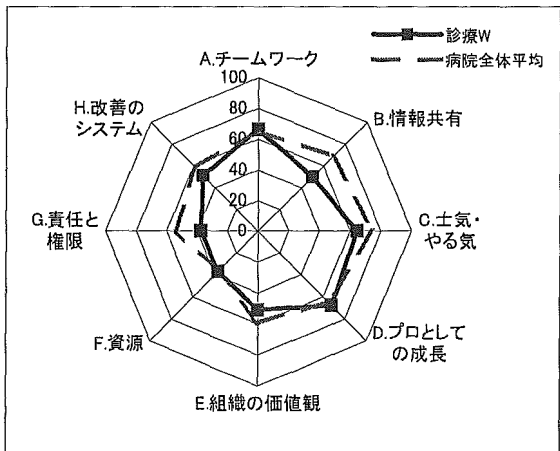
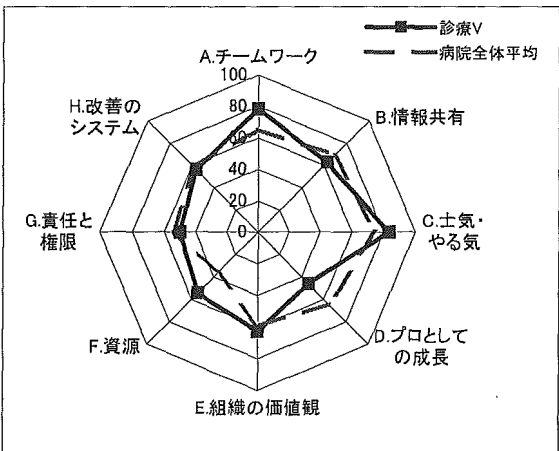
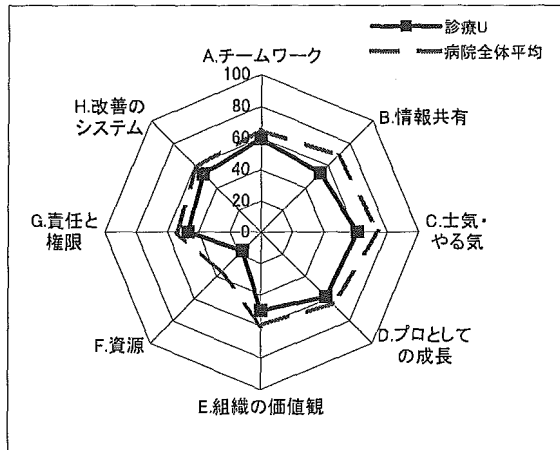
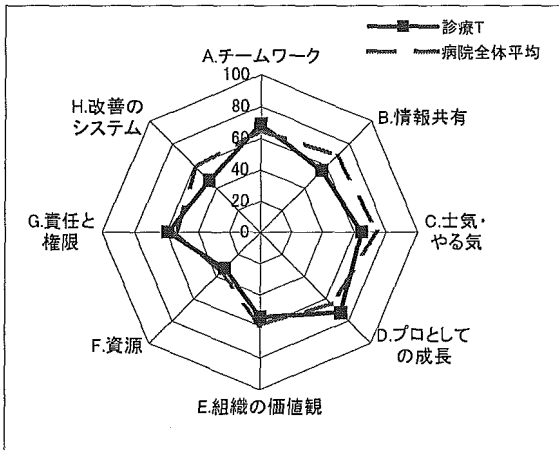
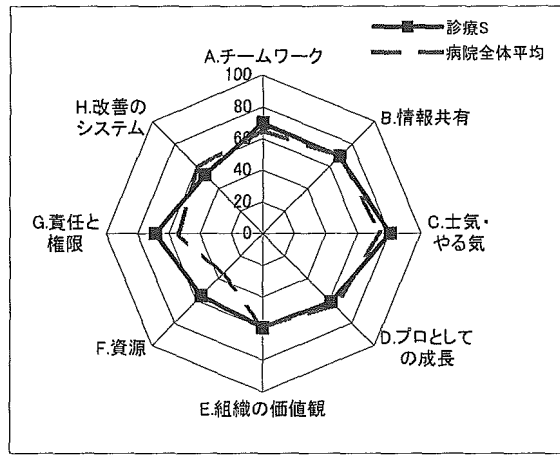
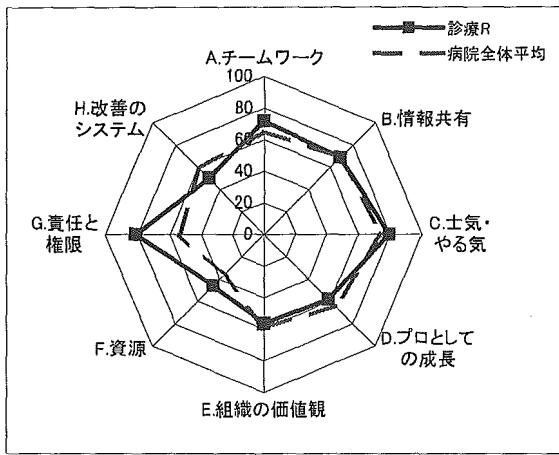

診療科間比較

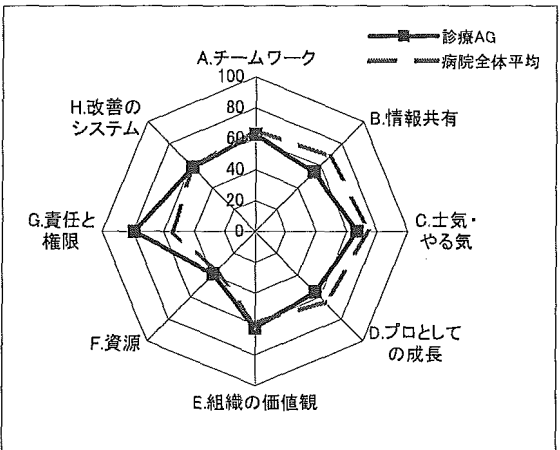
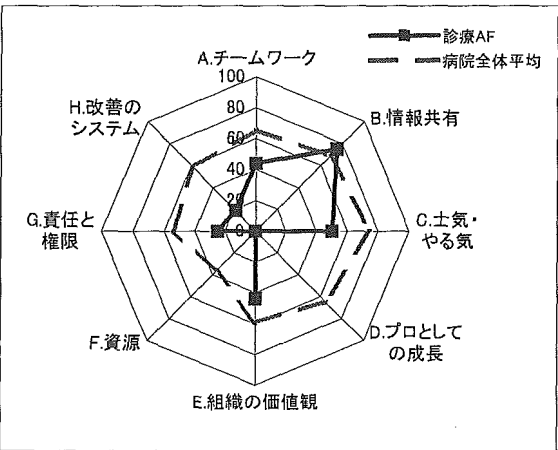
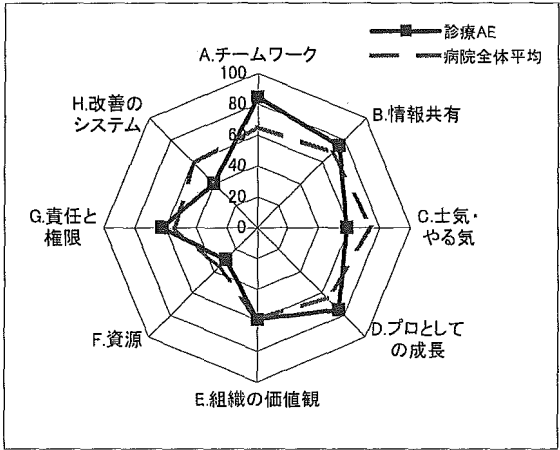
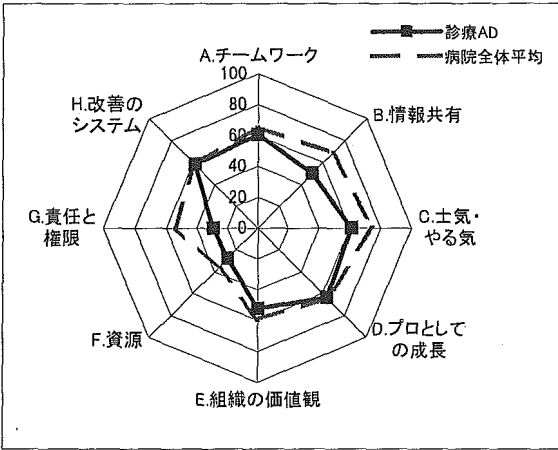
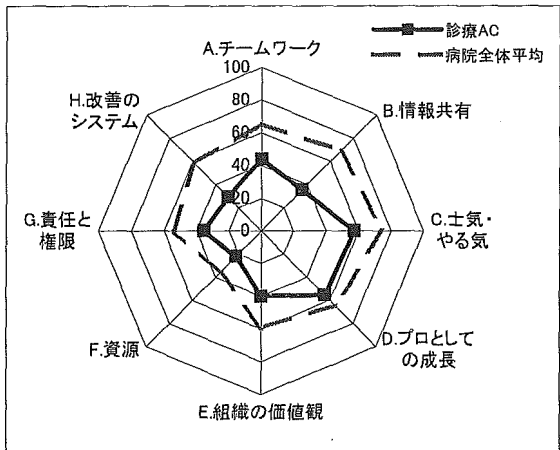
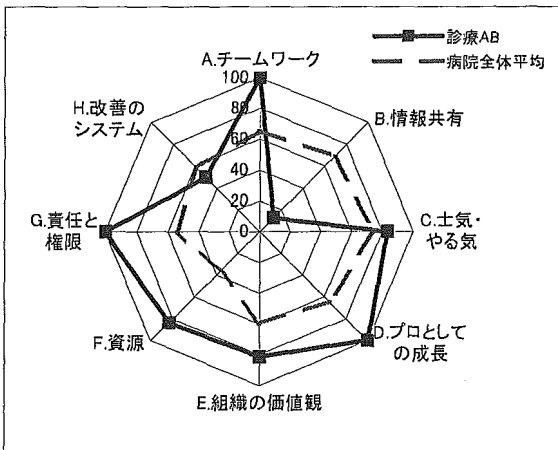
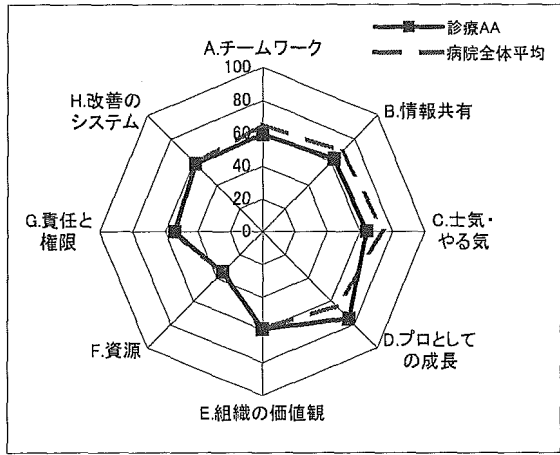
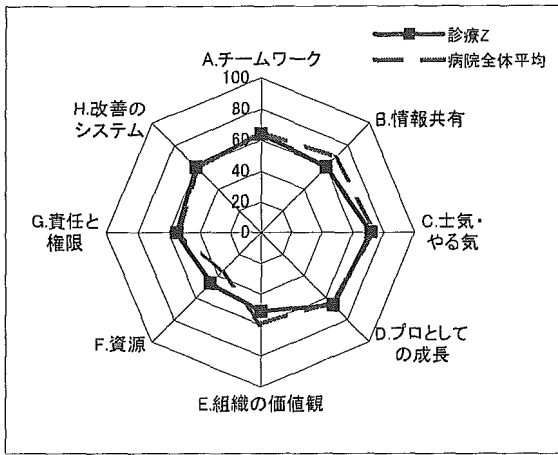

診療科間比較

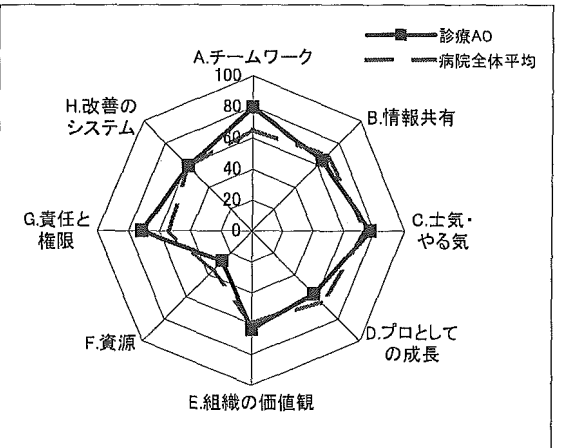
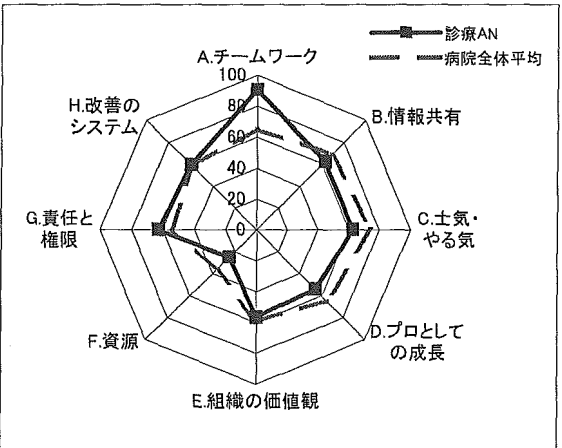
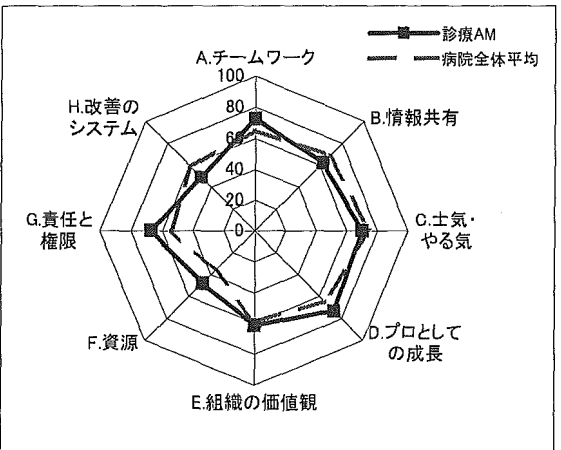
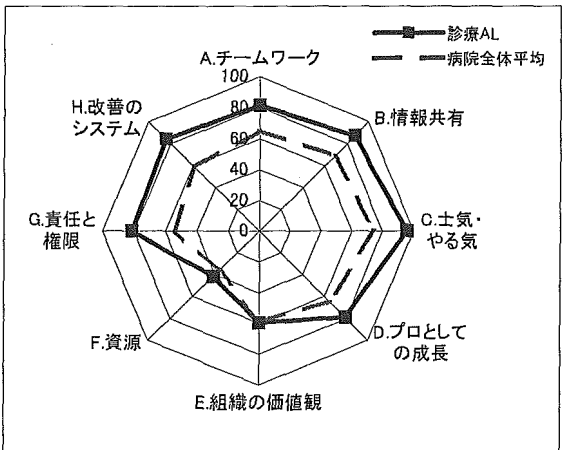
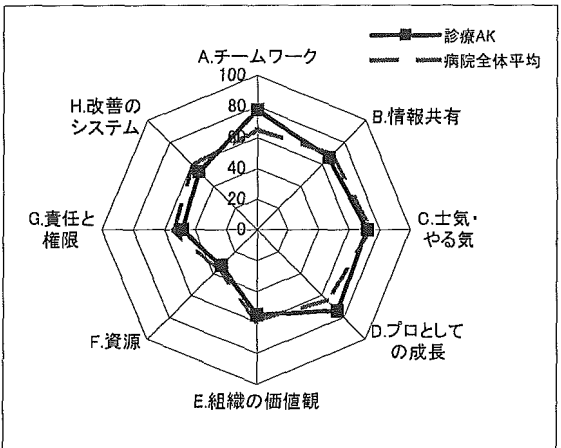
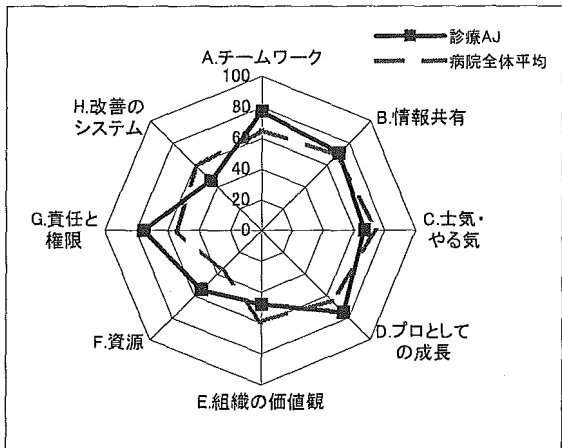
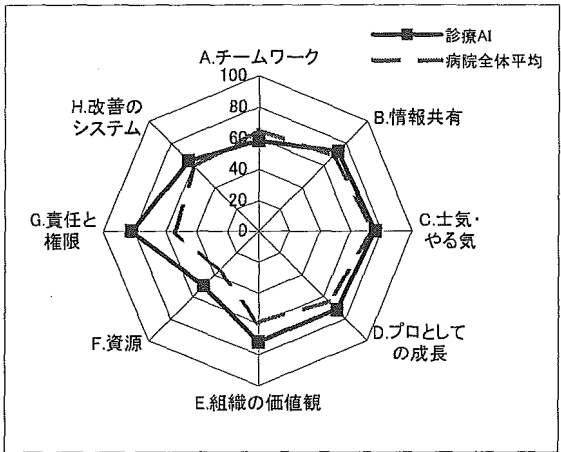
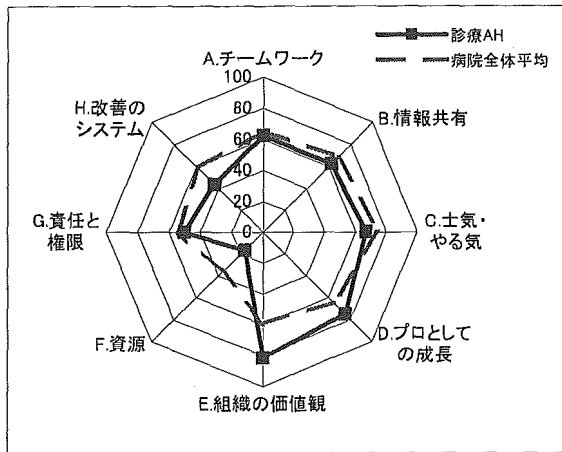

診療科間比較

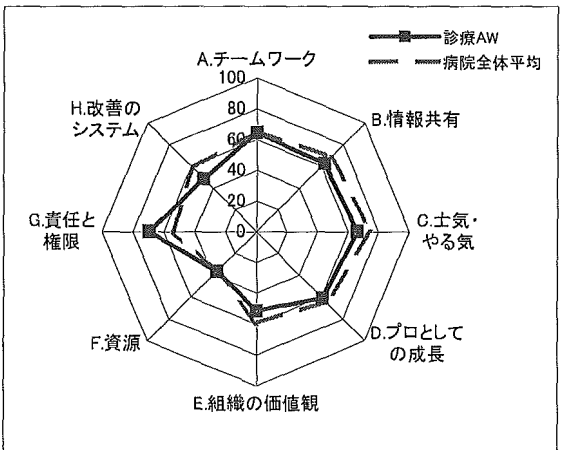
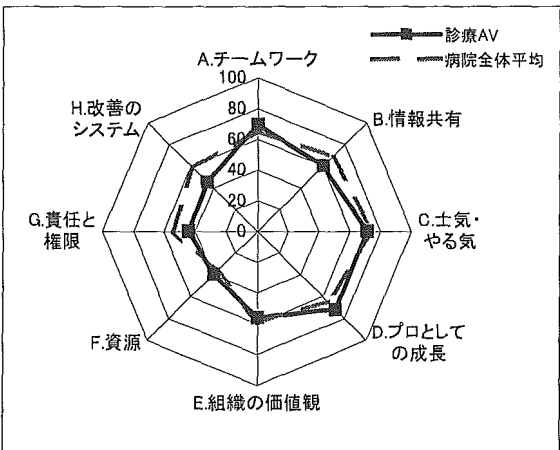
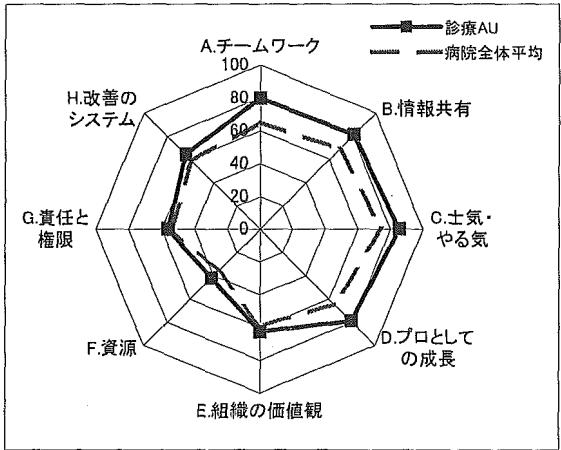
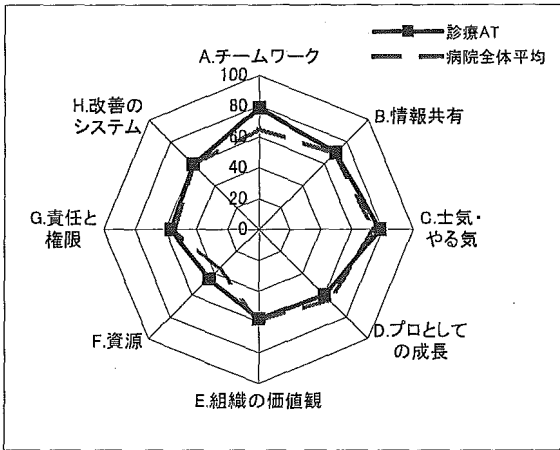
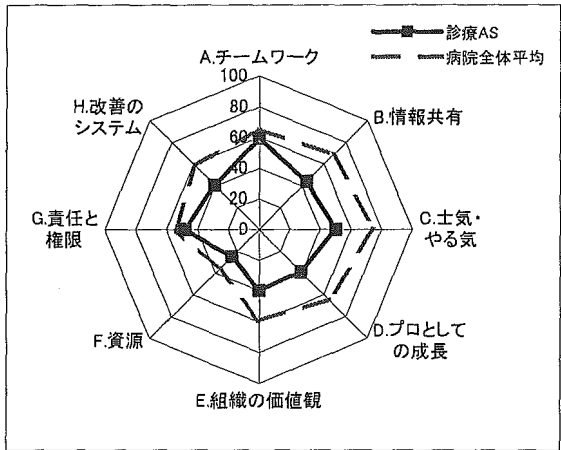
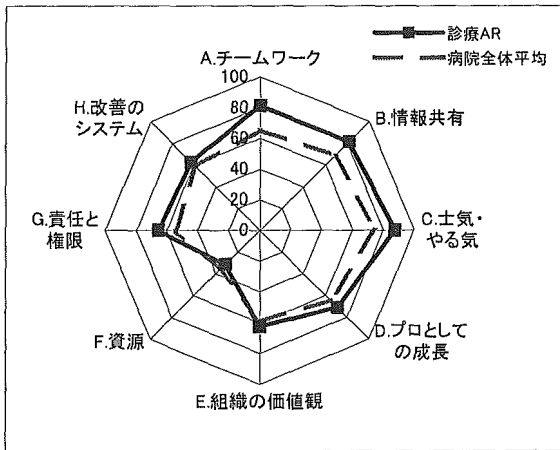
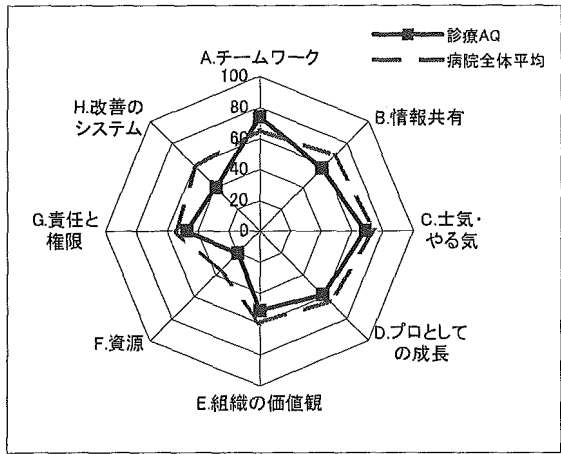
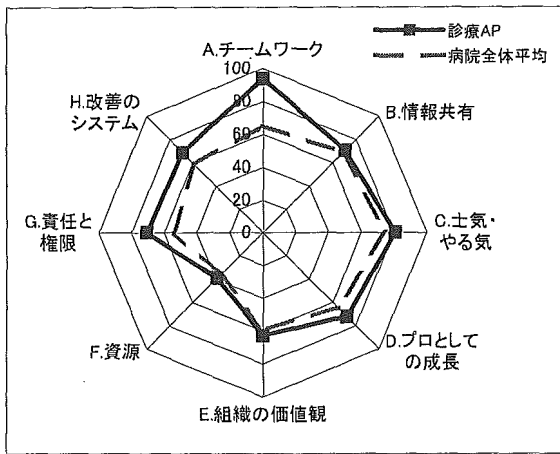

診療科間比較

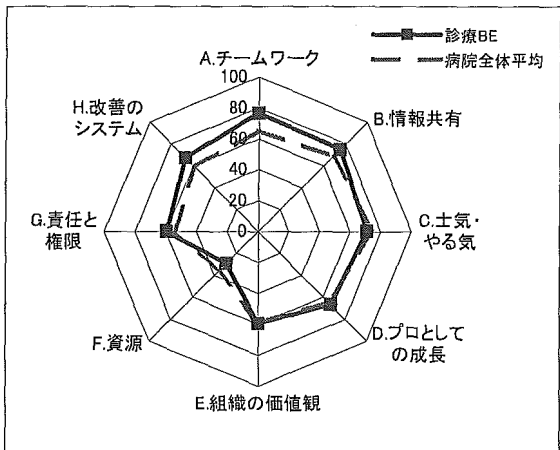
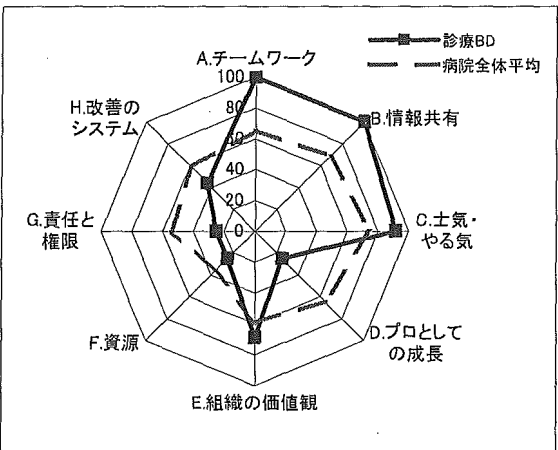
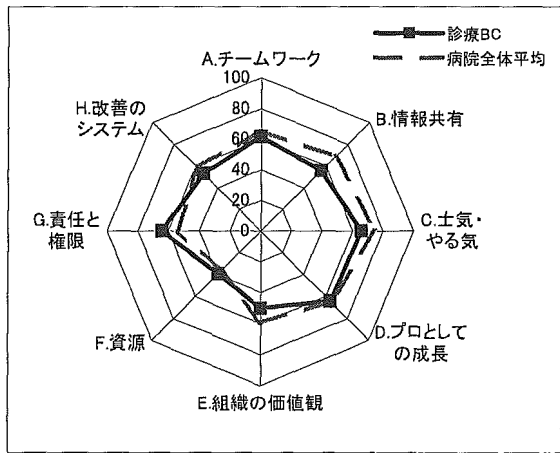
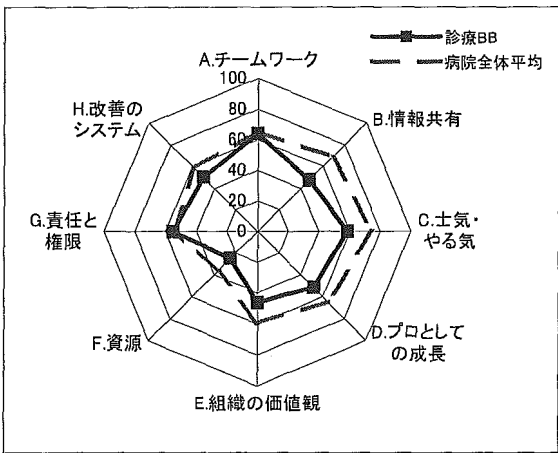
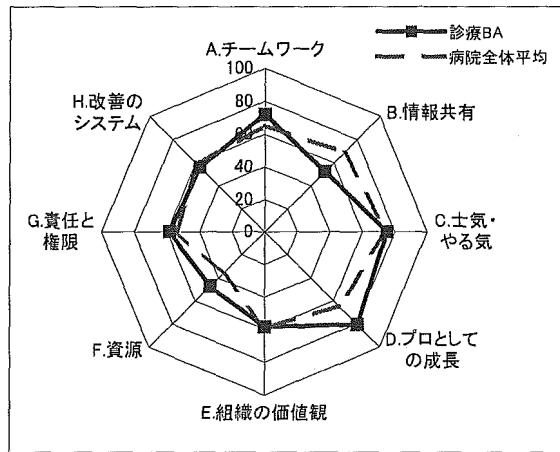
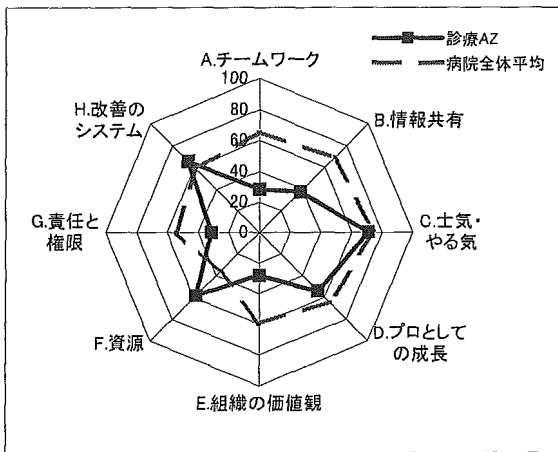
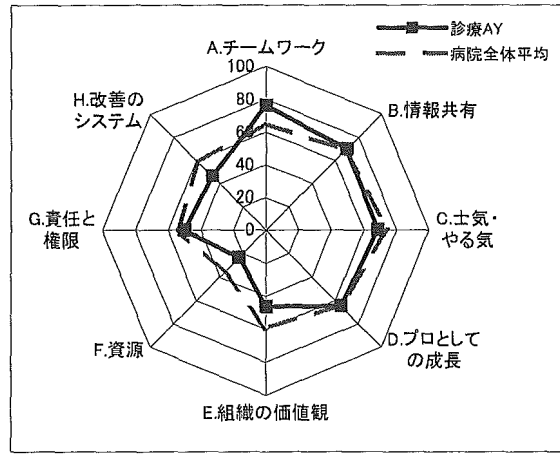
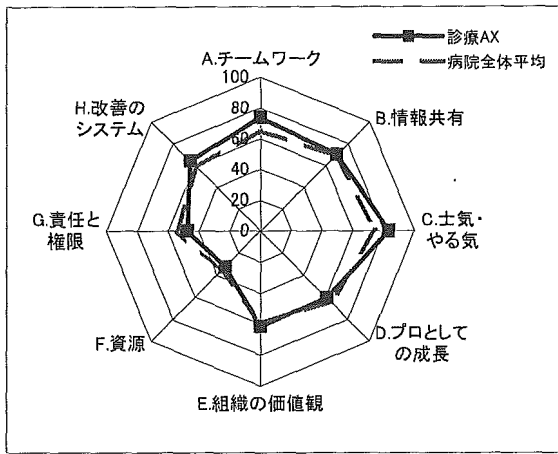

診療科間比較

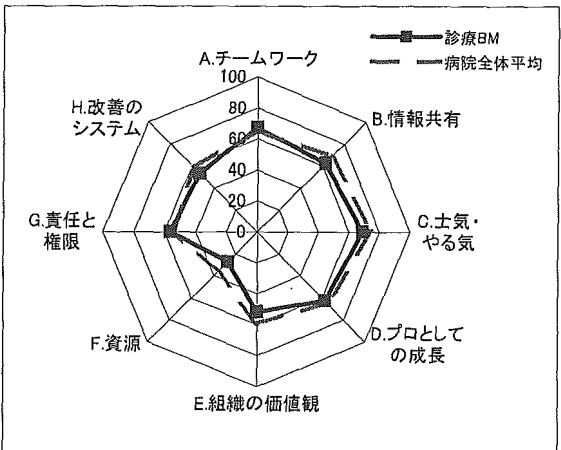
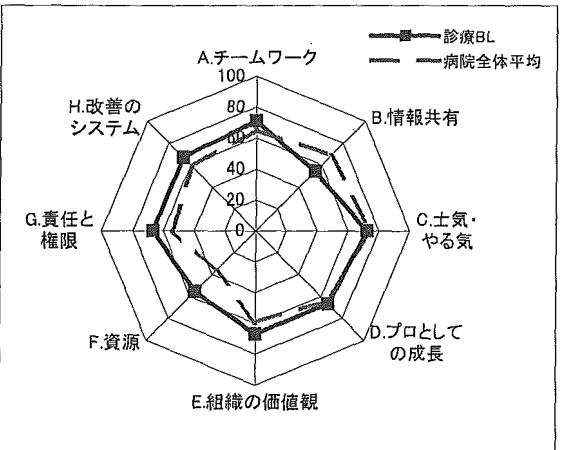
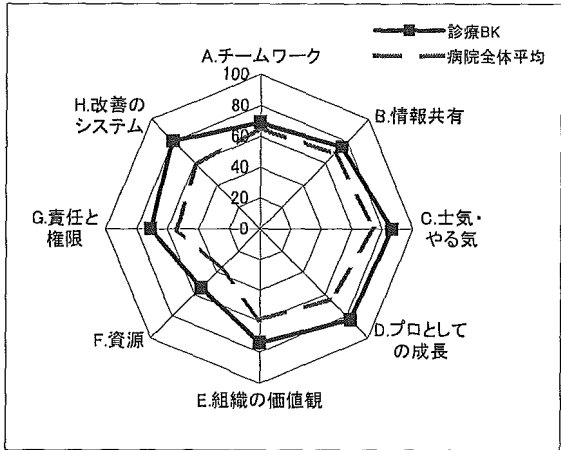
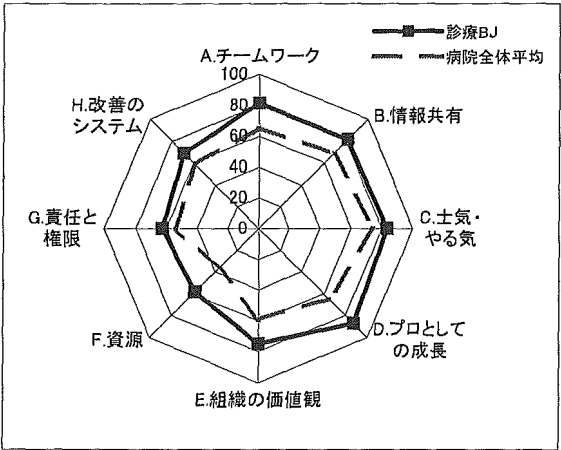
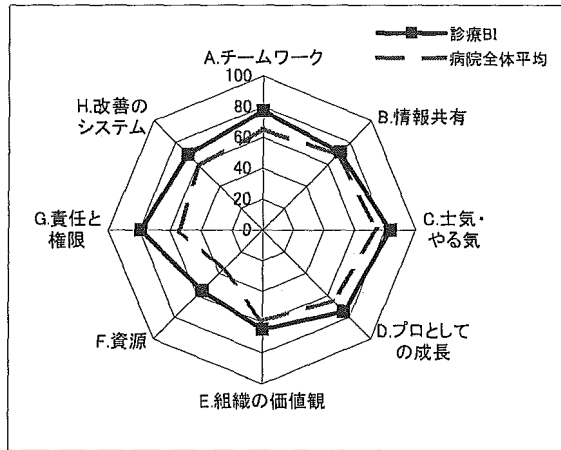
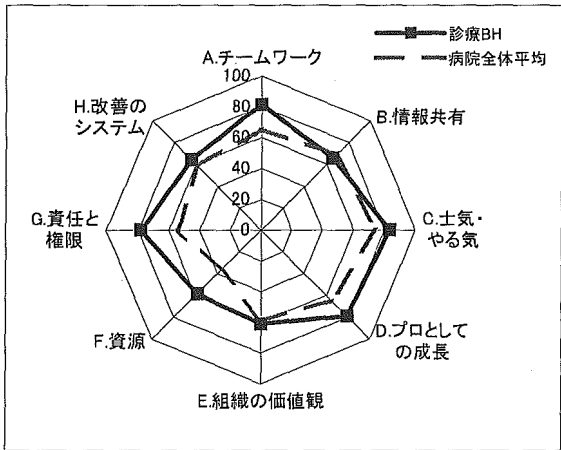
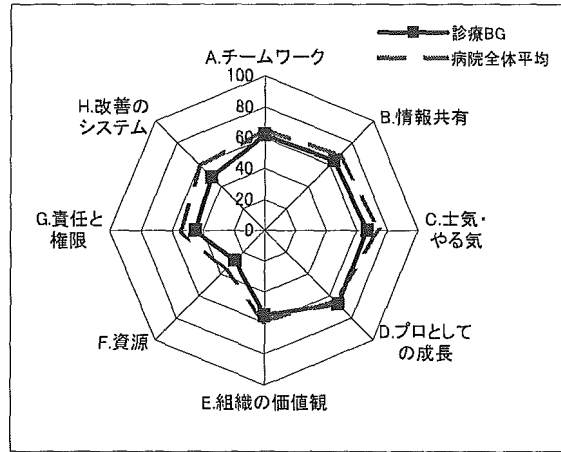
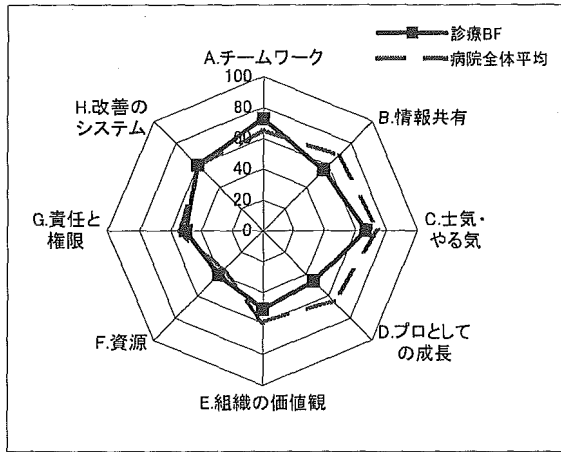

診療科間比較

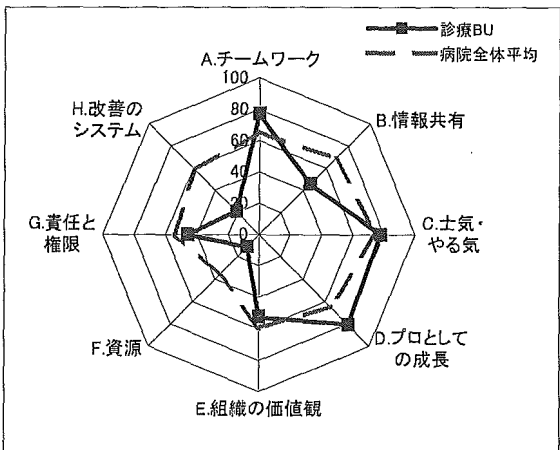
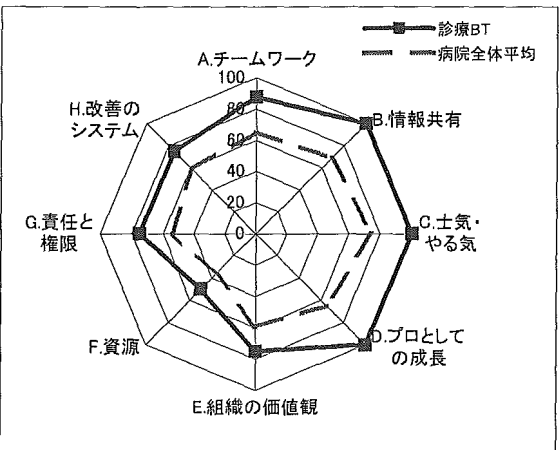
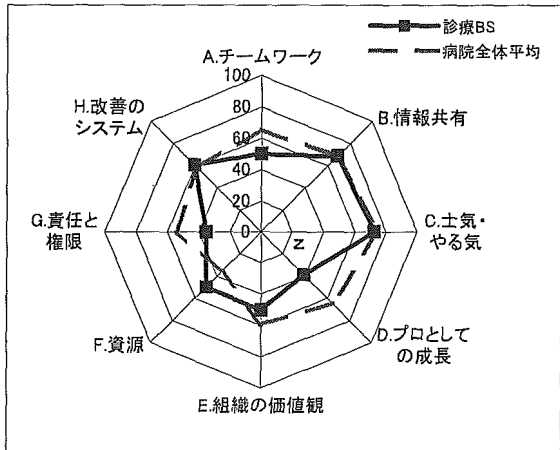
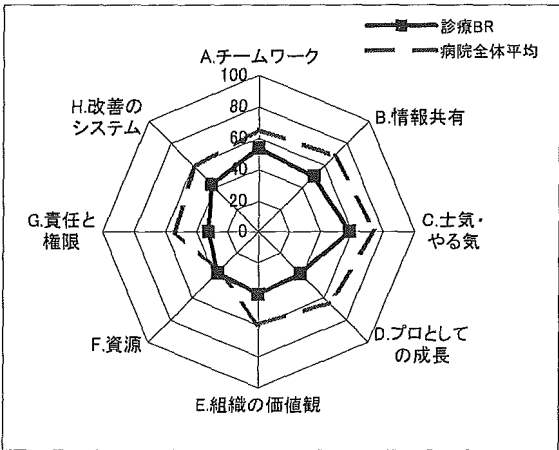
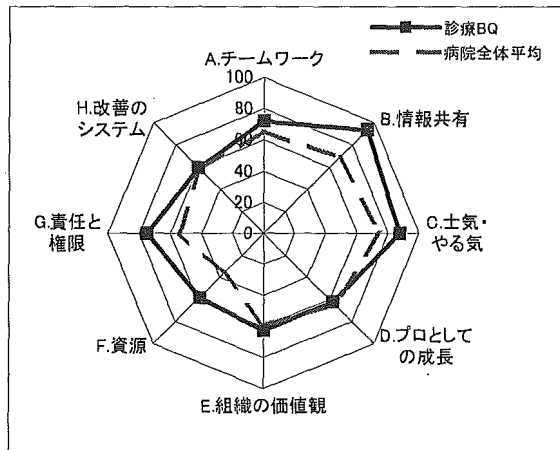
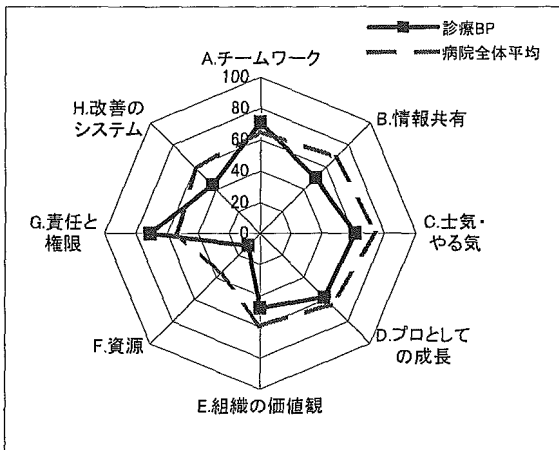
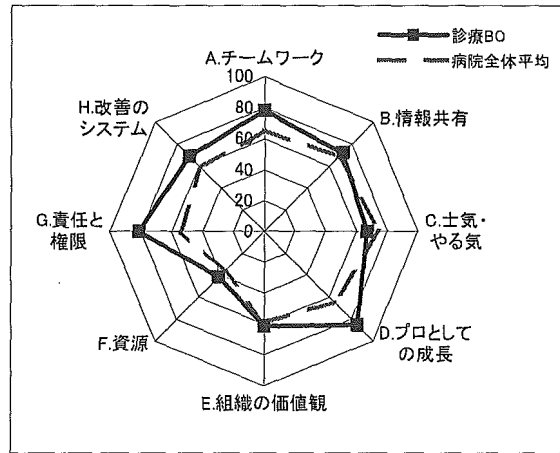
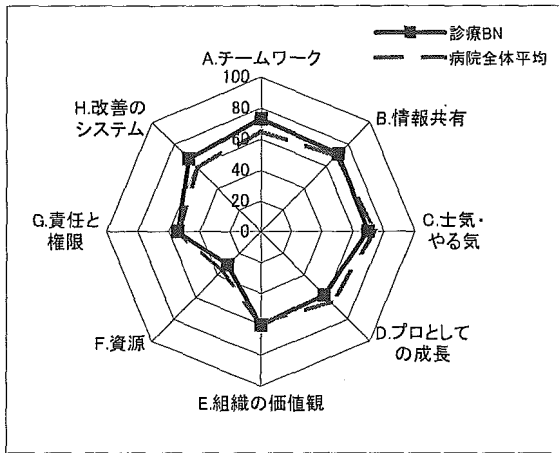

診療科間比較

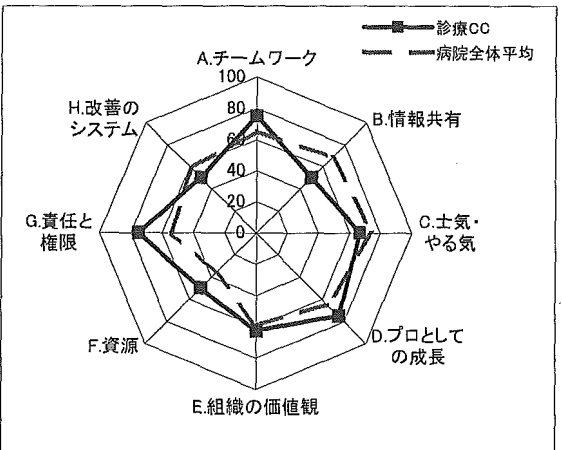
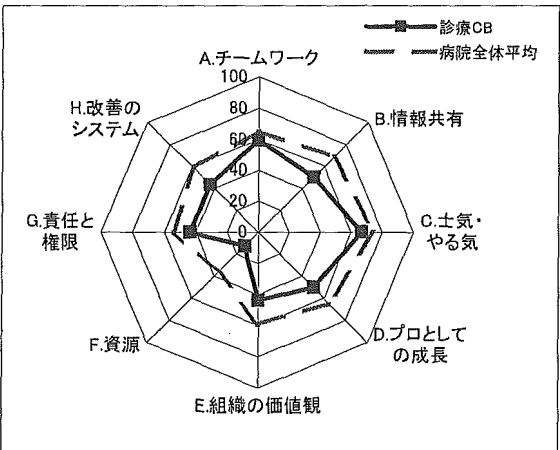
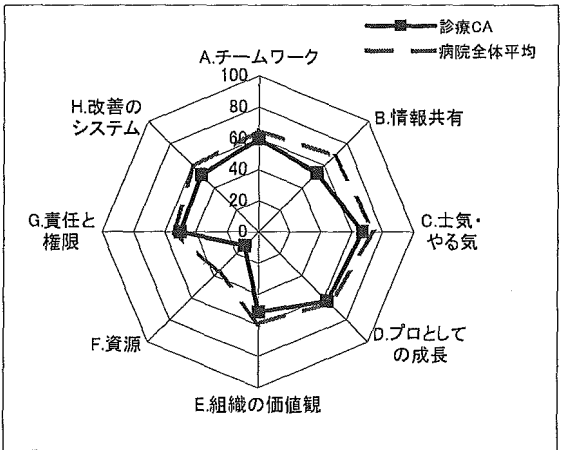
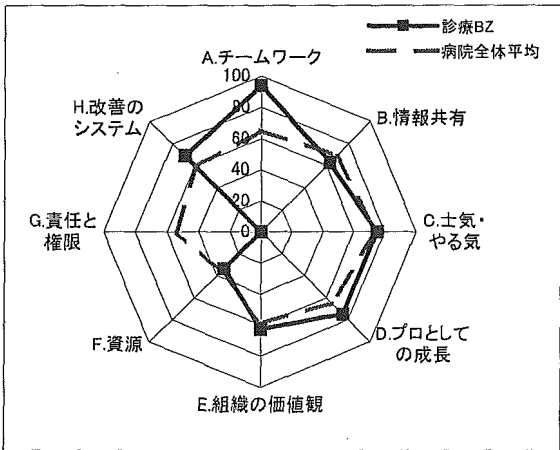
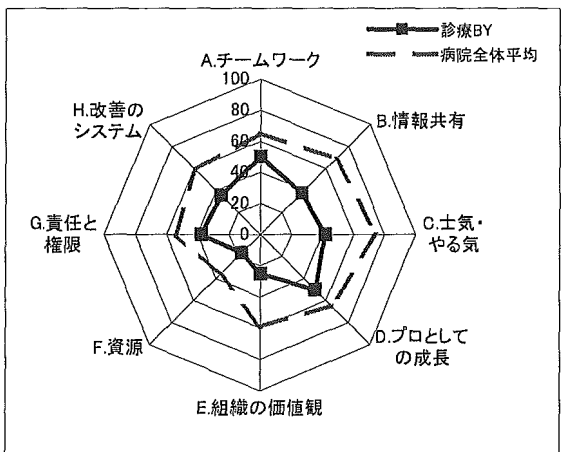
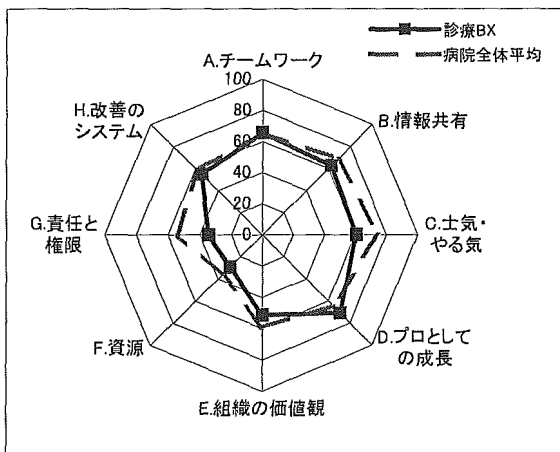
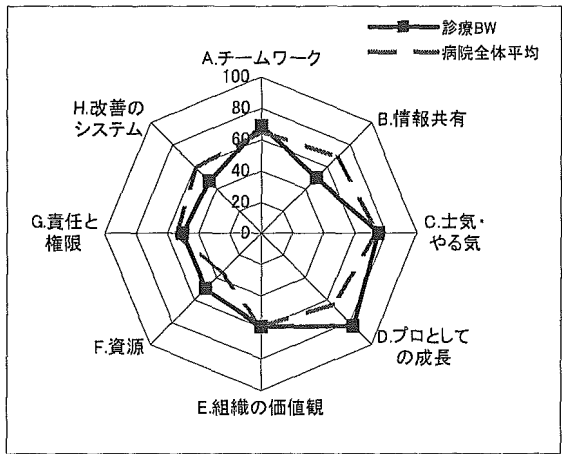
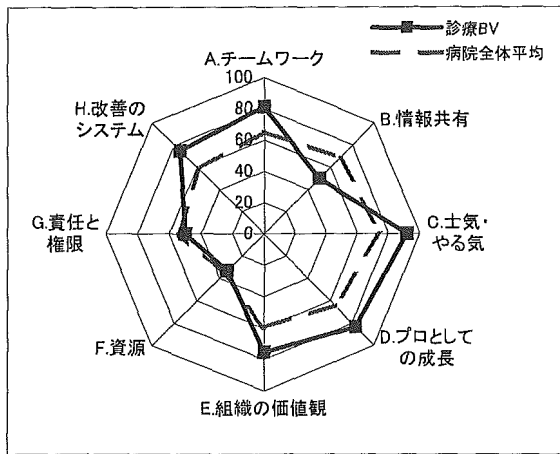

診療科間比較

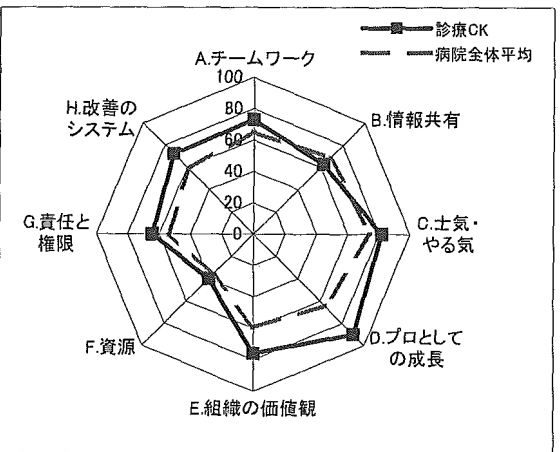
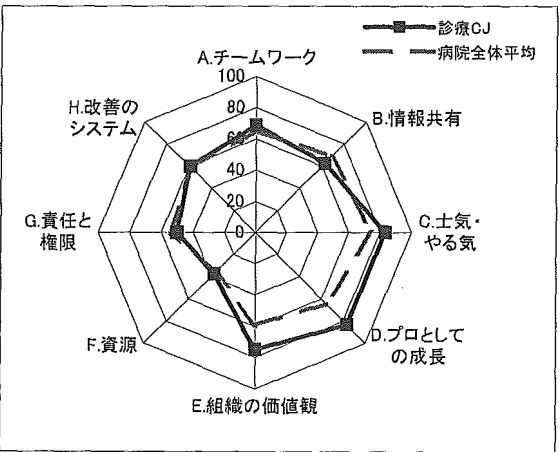
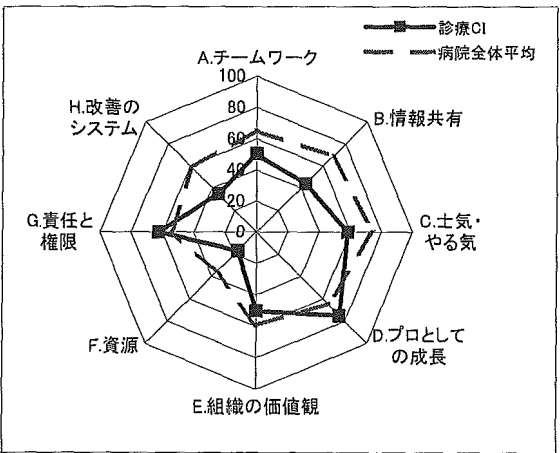
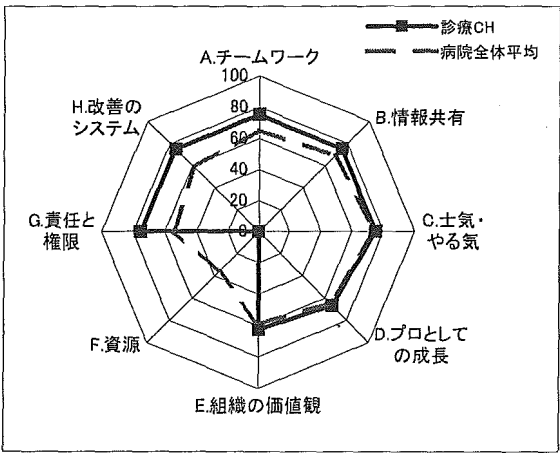
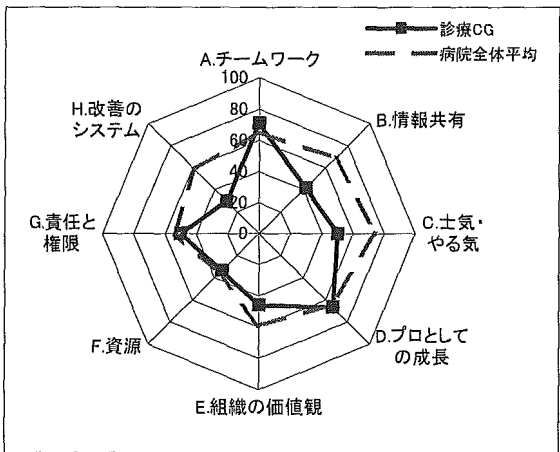
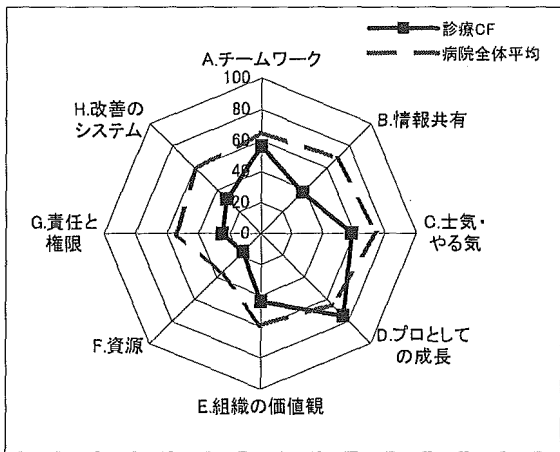
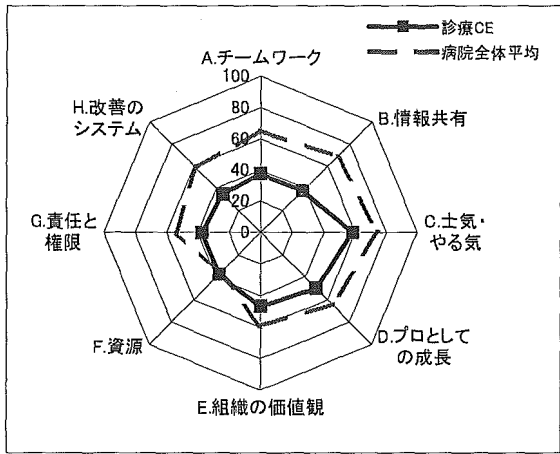
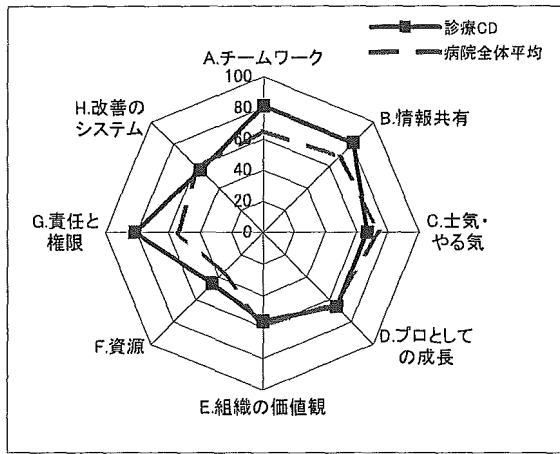

診療科間比較

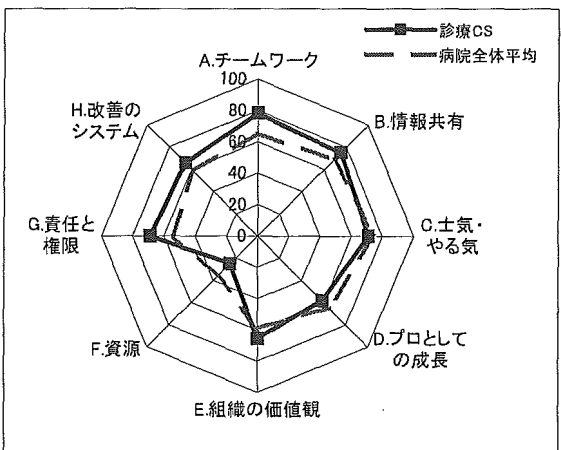
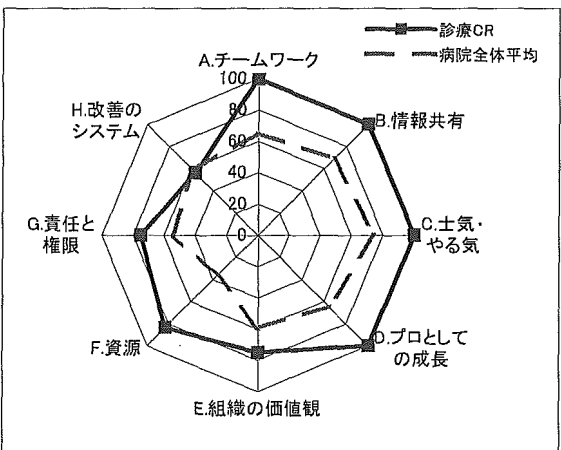
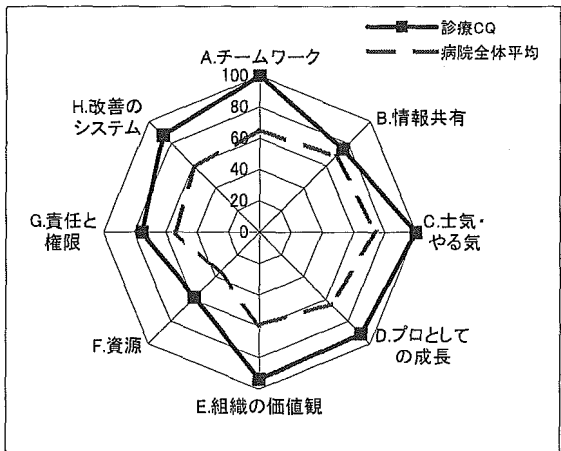
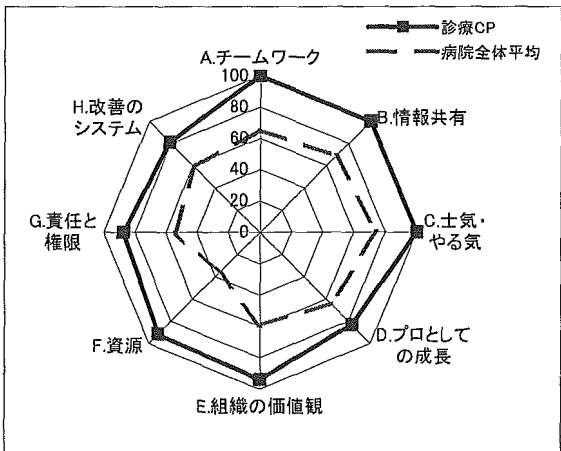
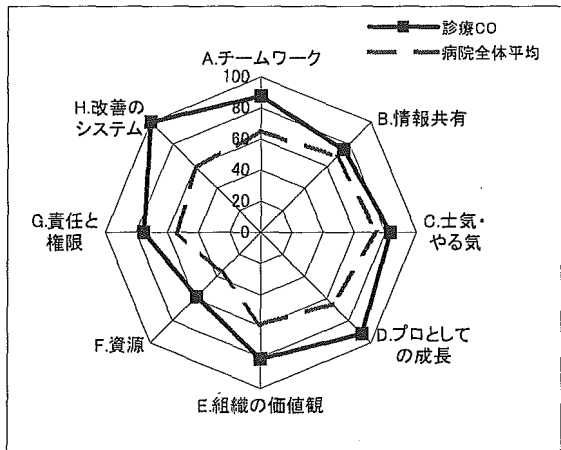
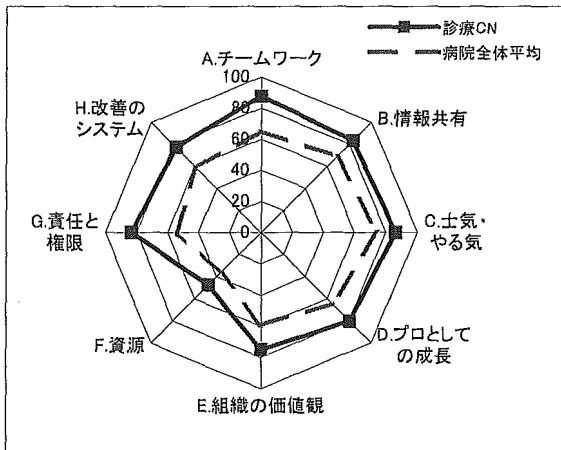
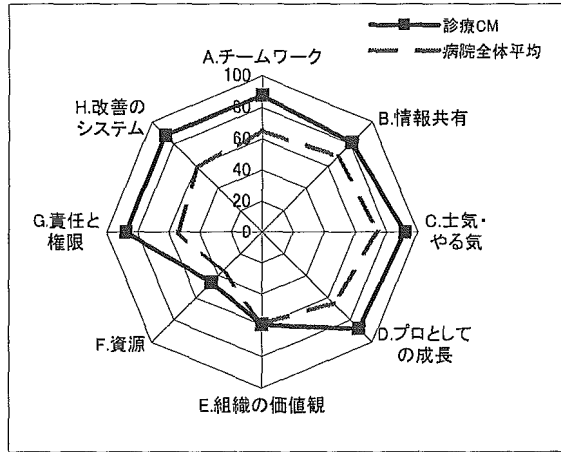
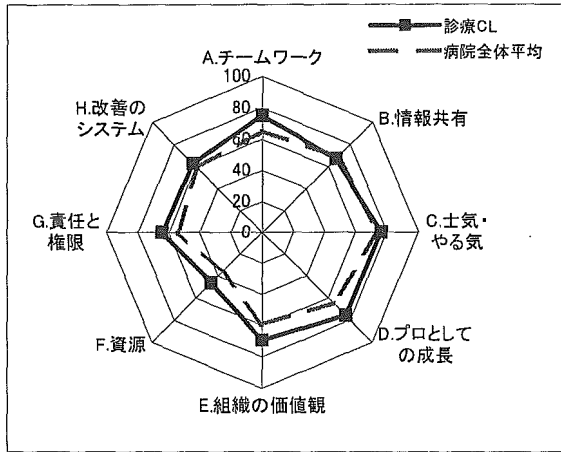

診療科間比較

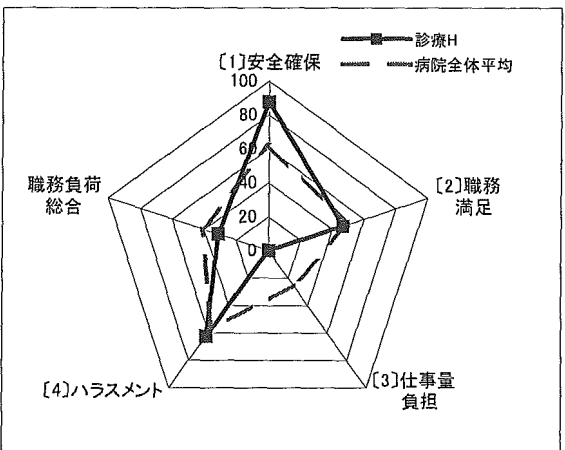
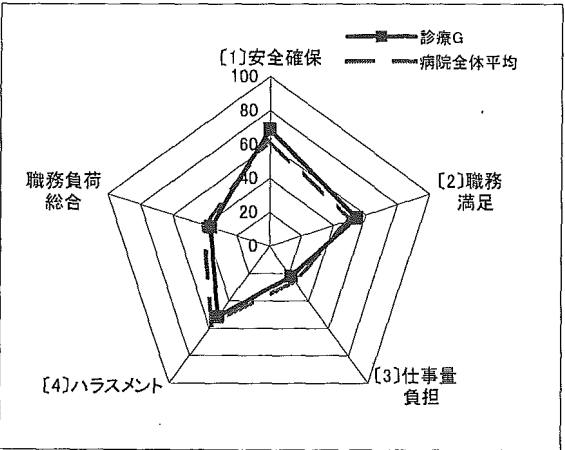
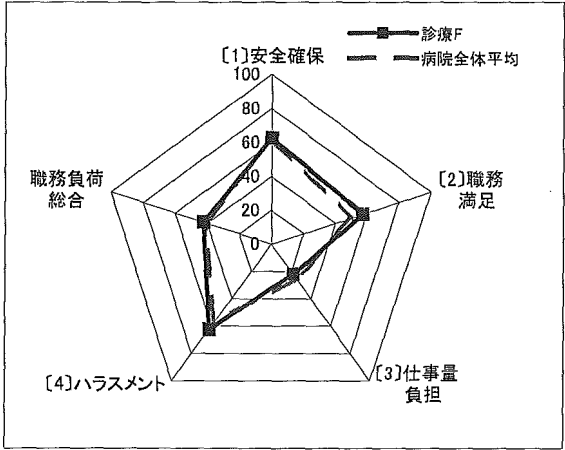
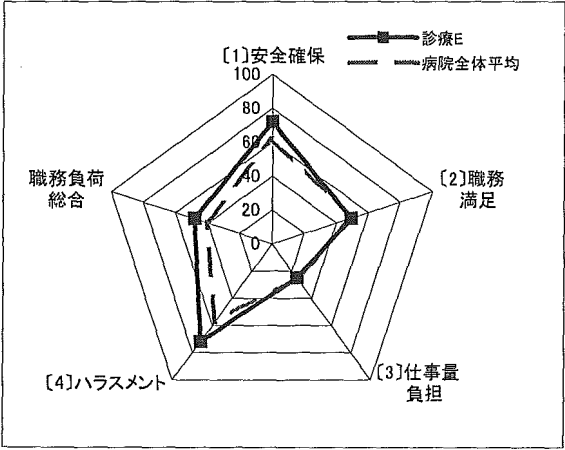
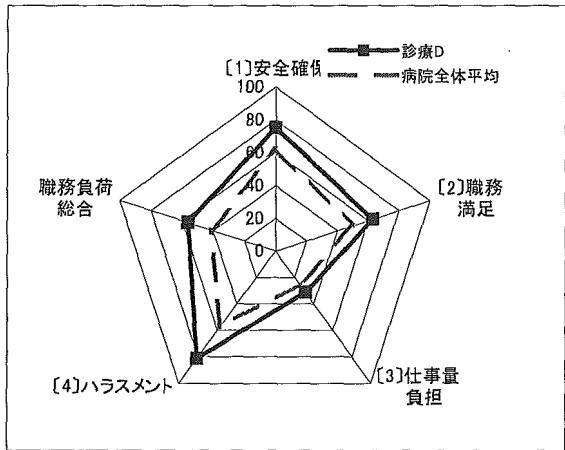
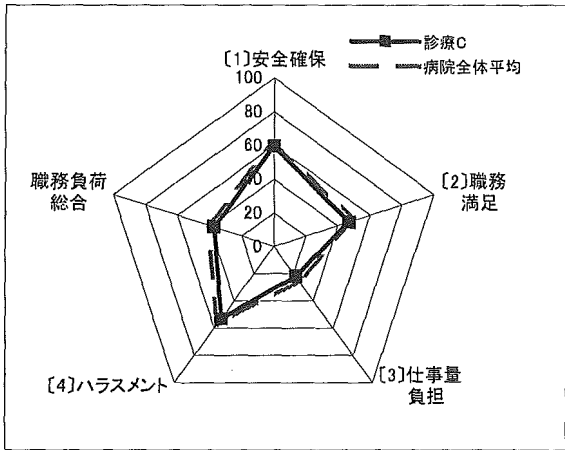
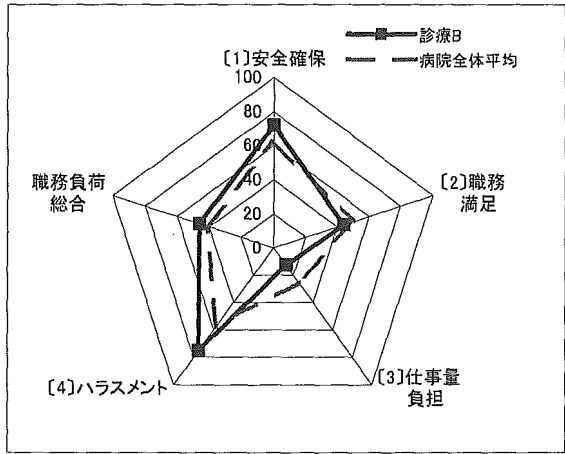
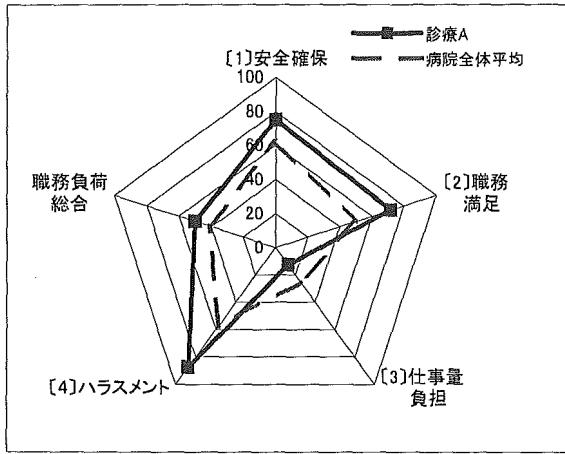

診療科間比較

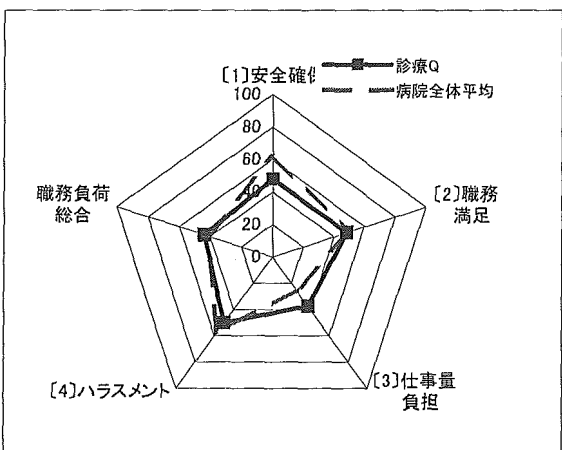
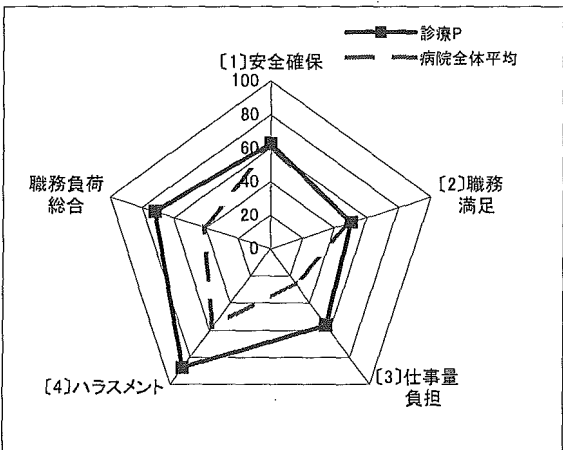
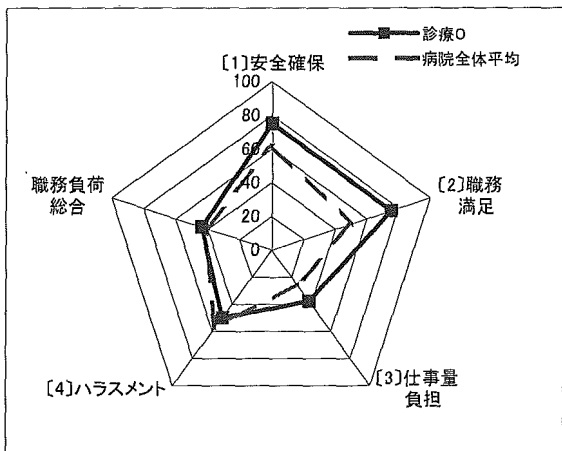
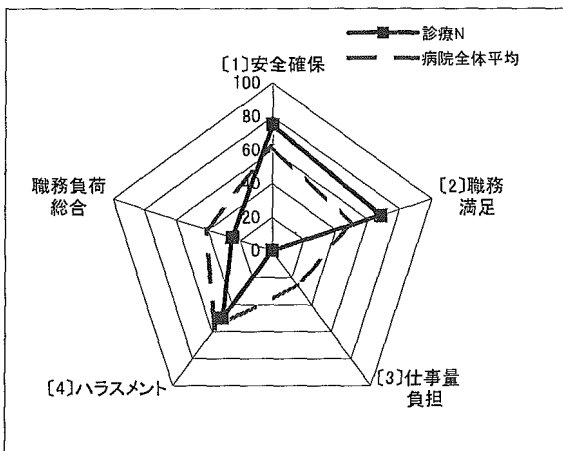
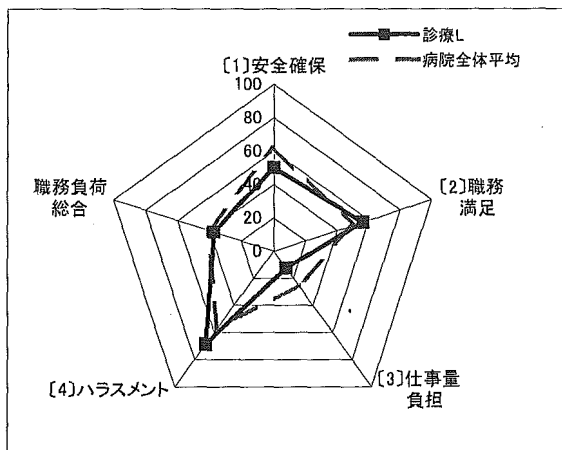
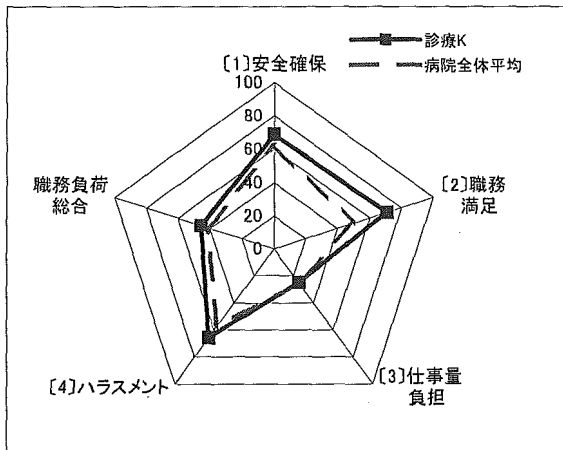
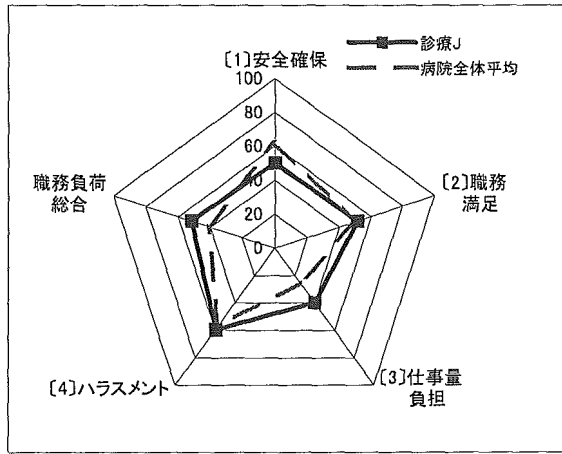
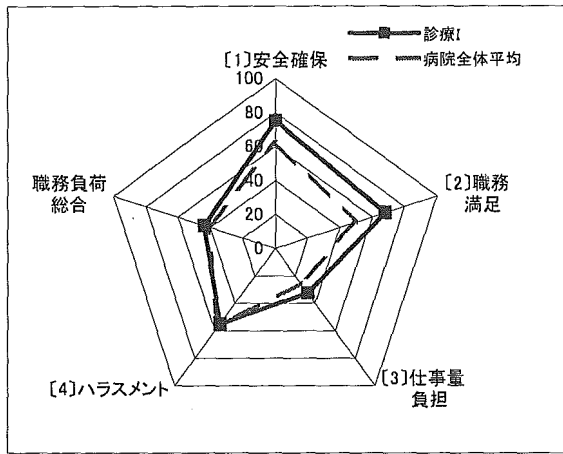

診療科間比較

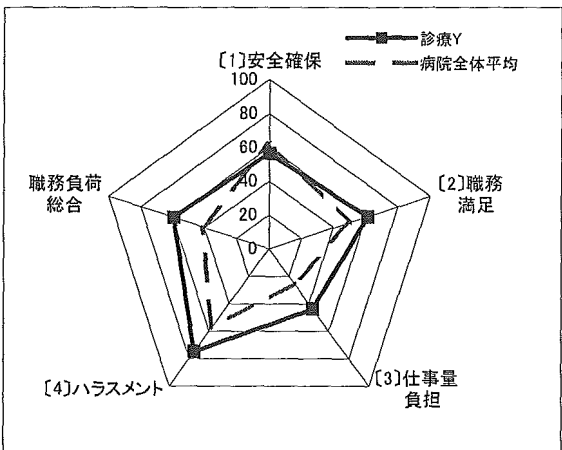
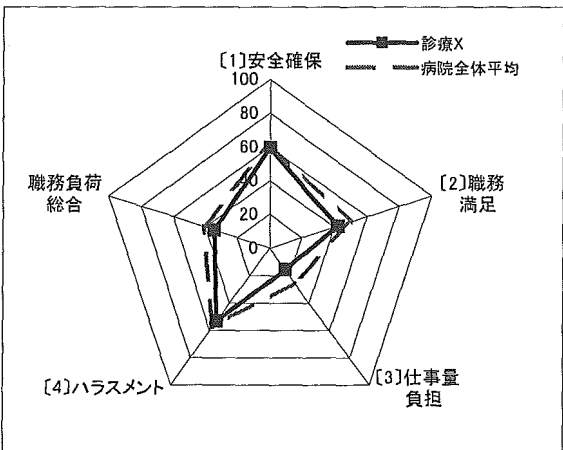
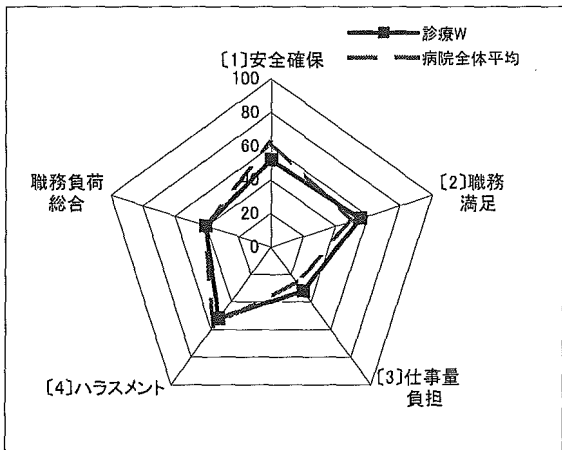
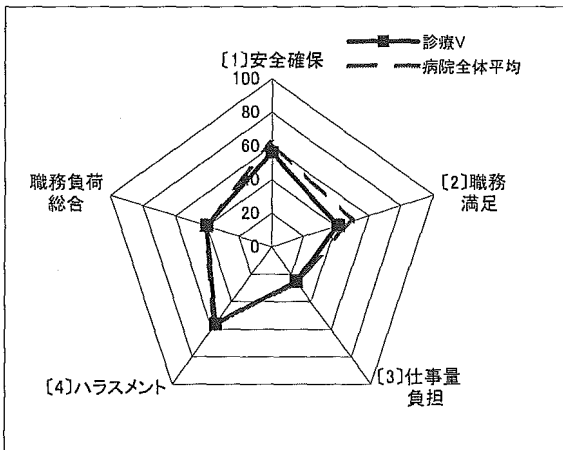
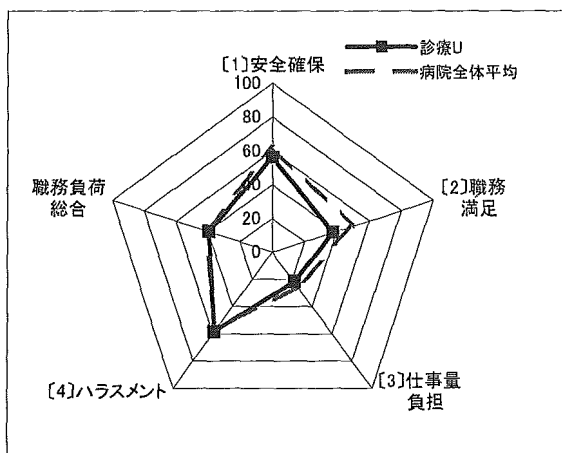
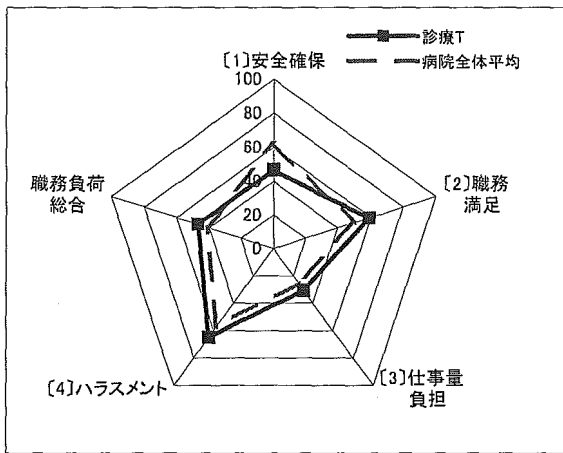
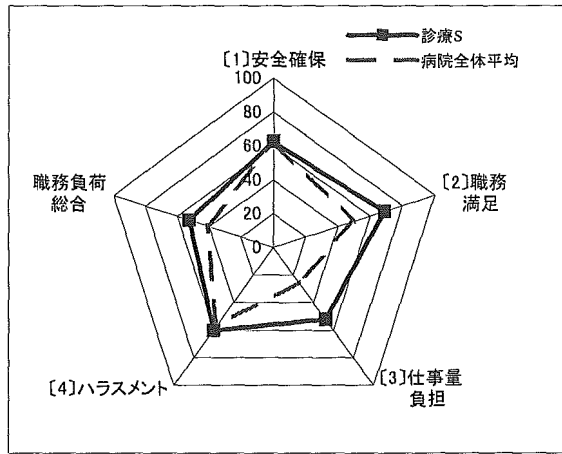
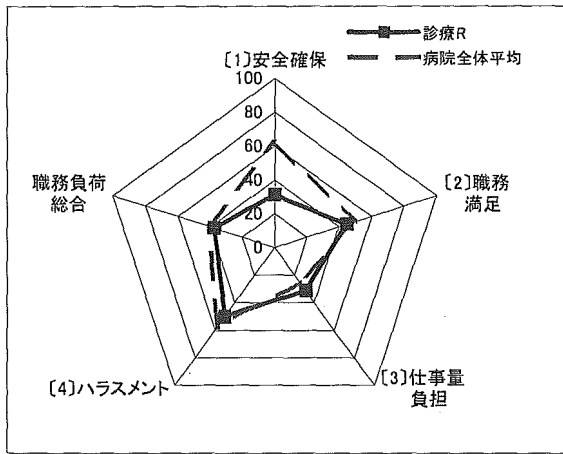

診療科間比較

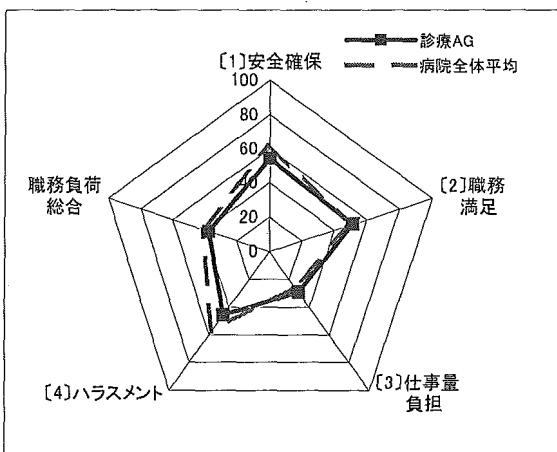
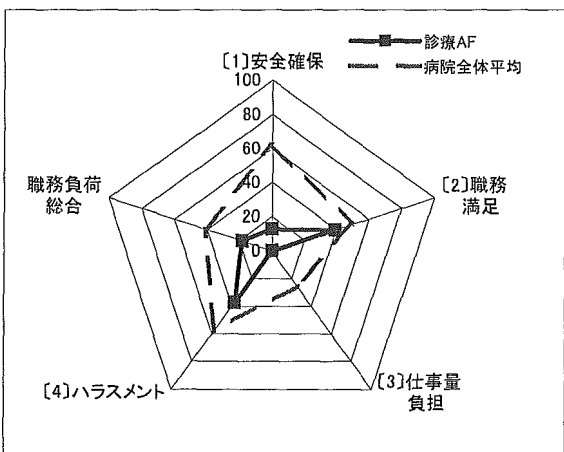
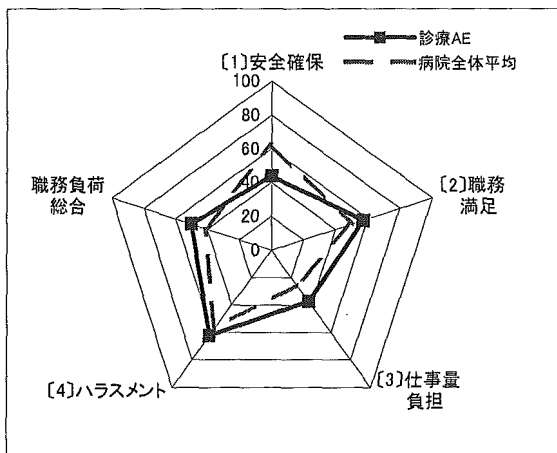
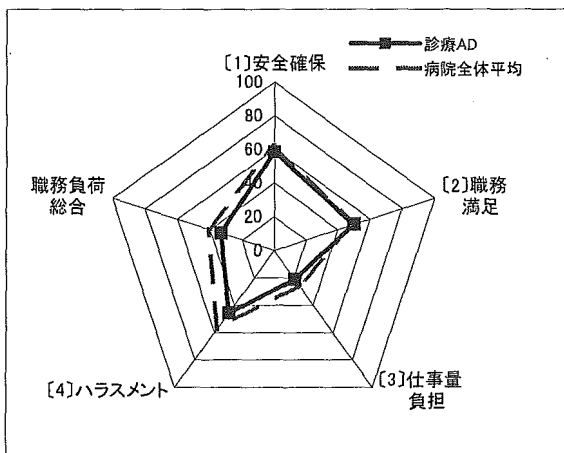
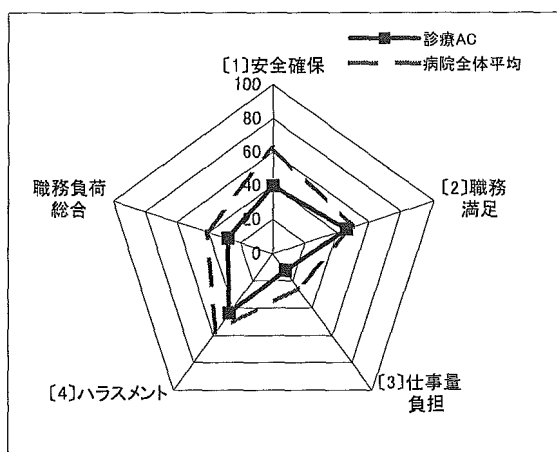
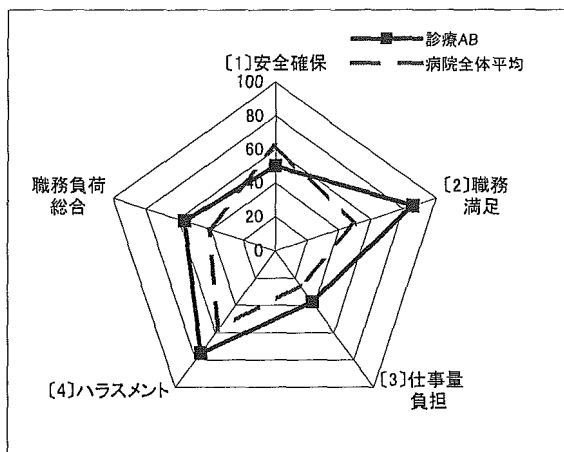
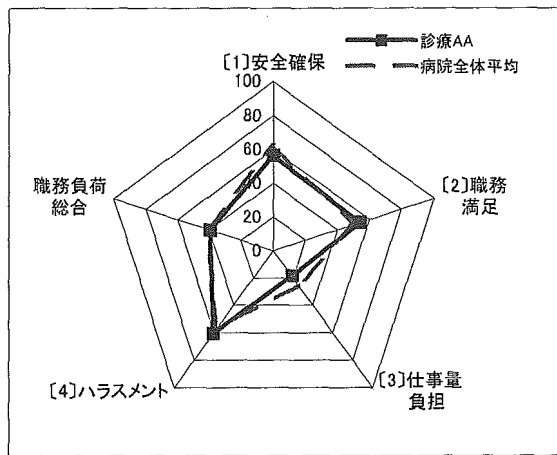
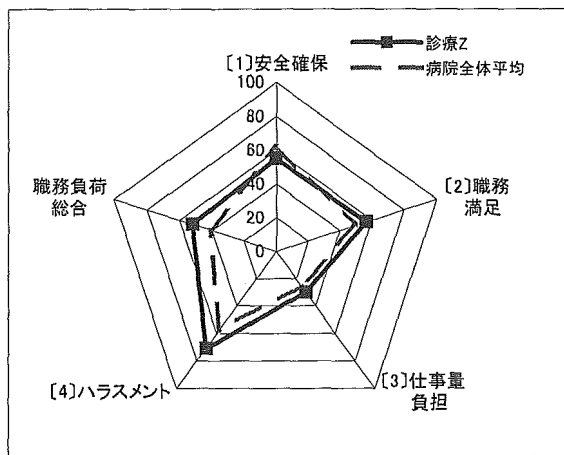

診療科間比較

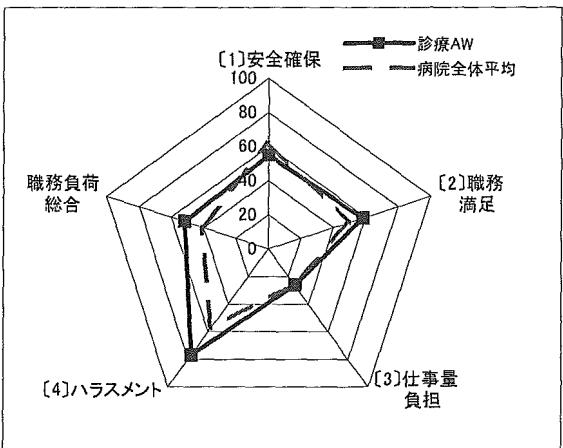
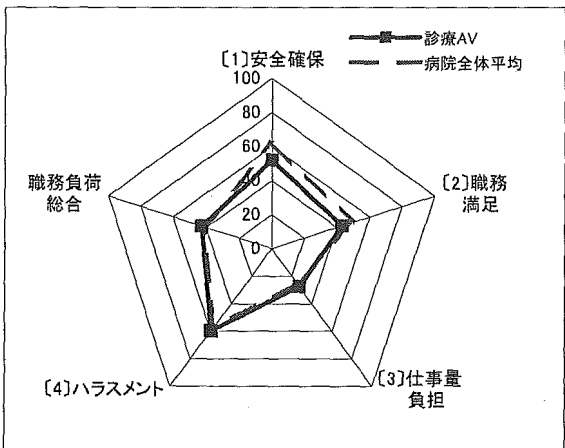
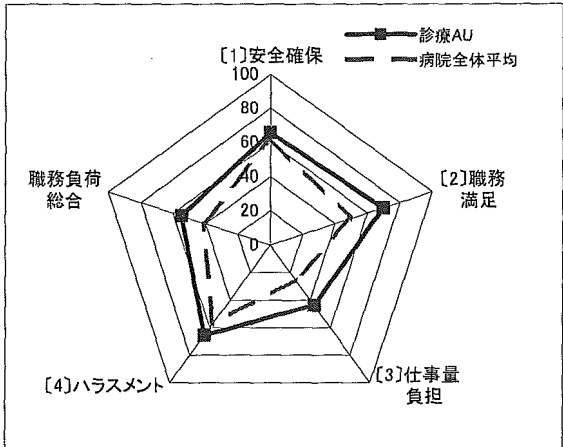
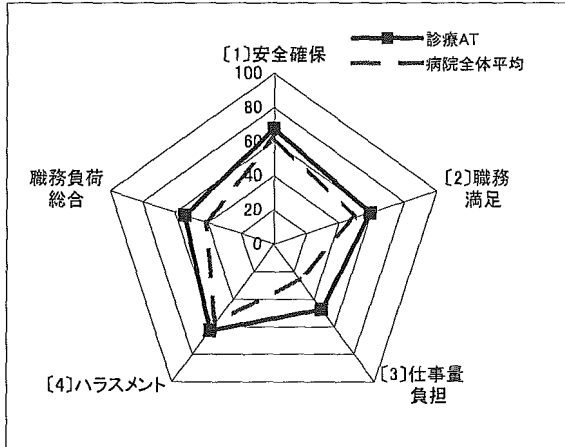
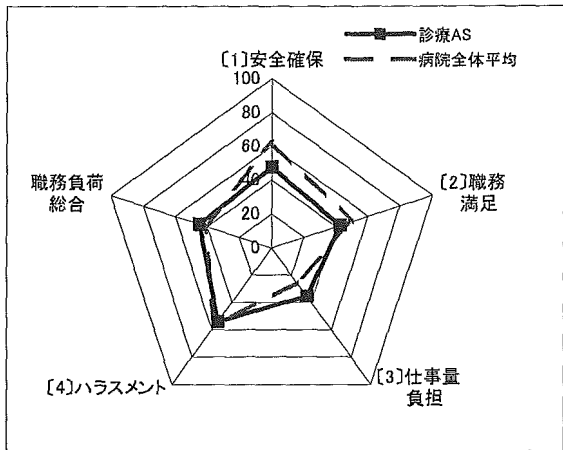
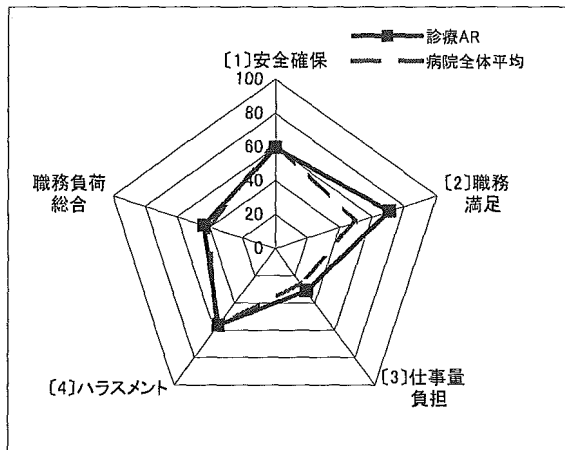
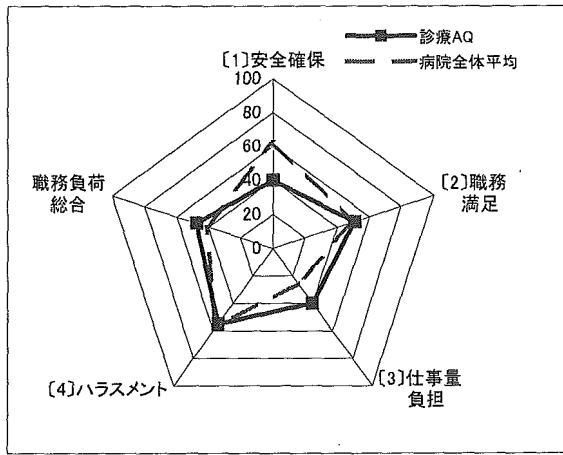
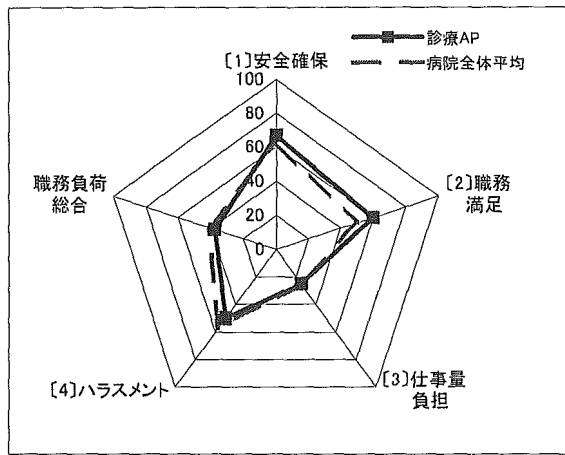

診療科間比較

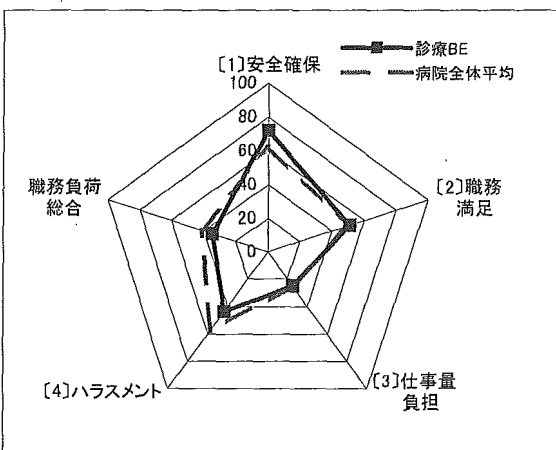
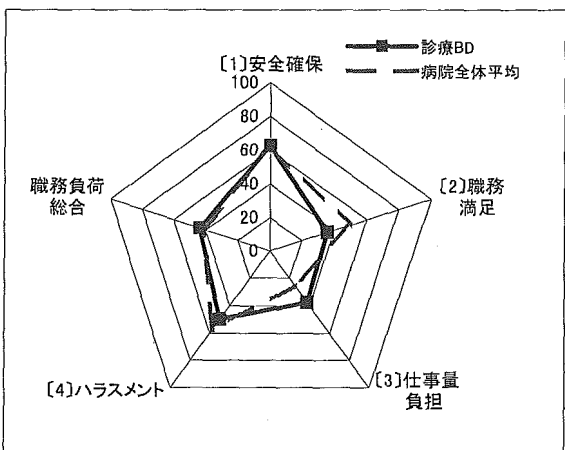
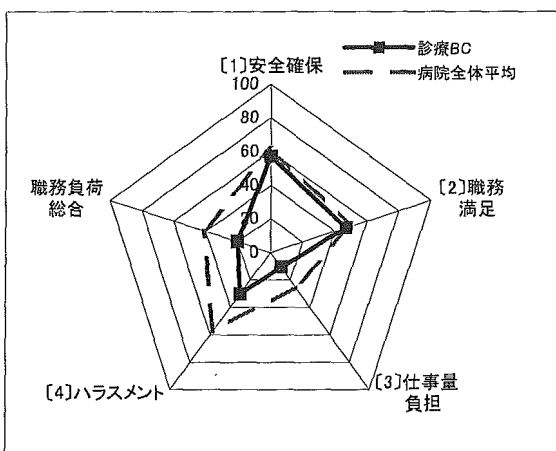
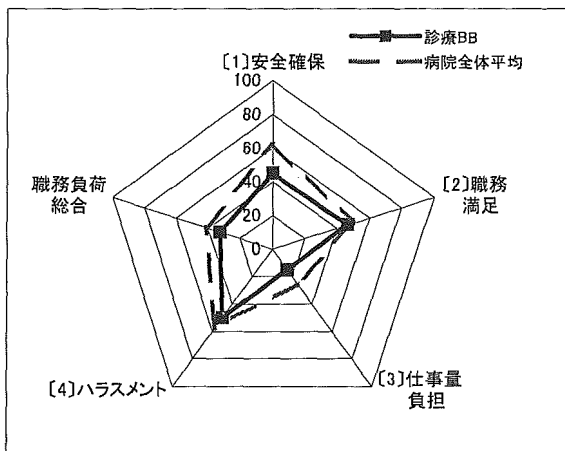
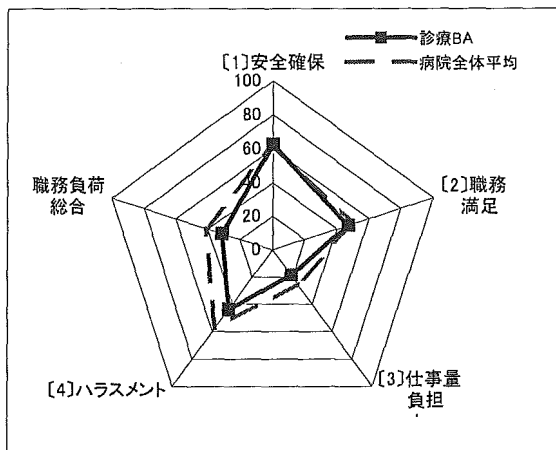
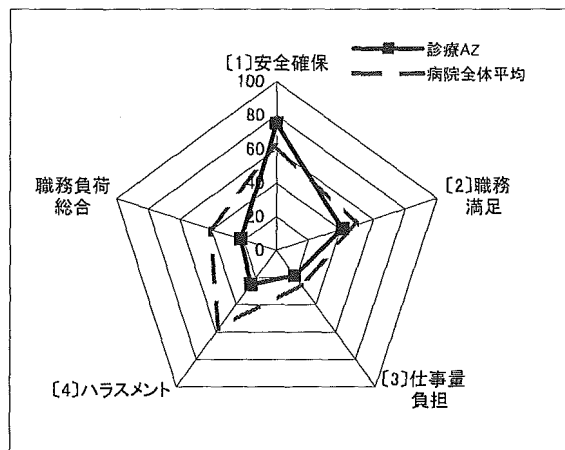
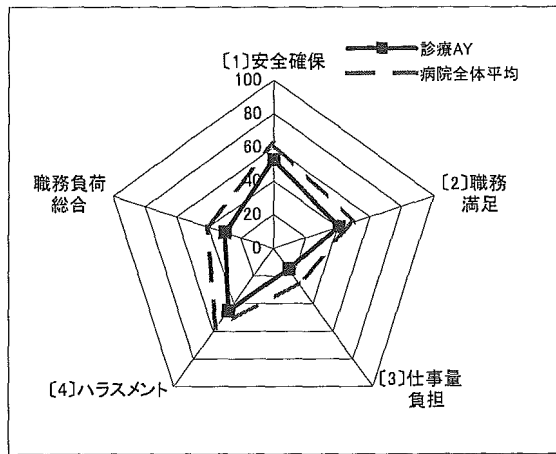
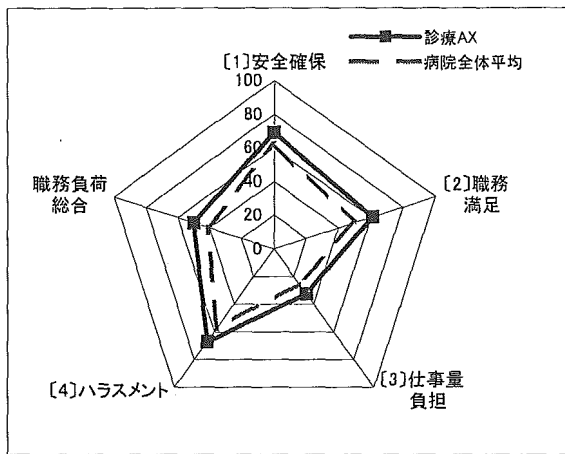

診療科間比較

