

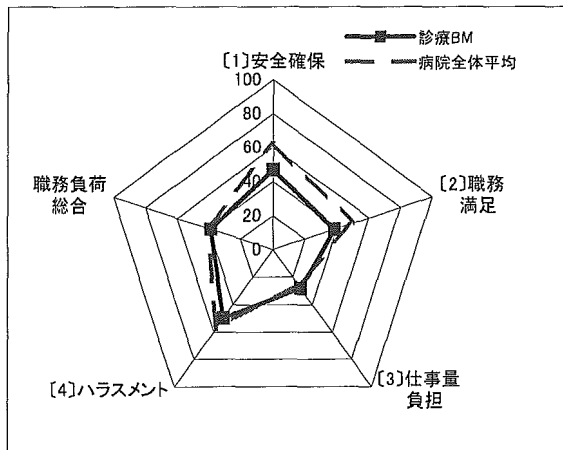

# 診療科間比較

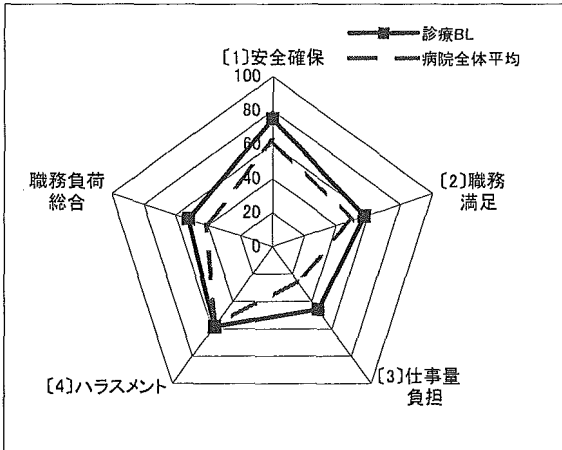

# 診療科間比較

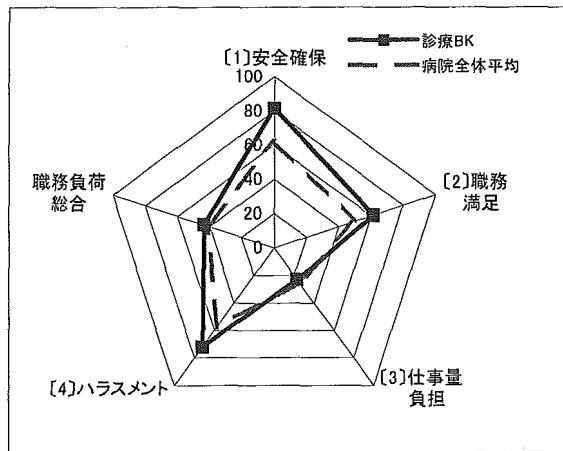
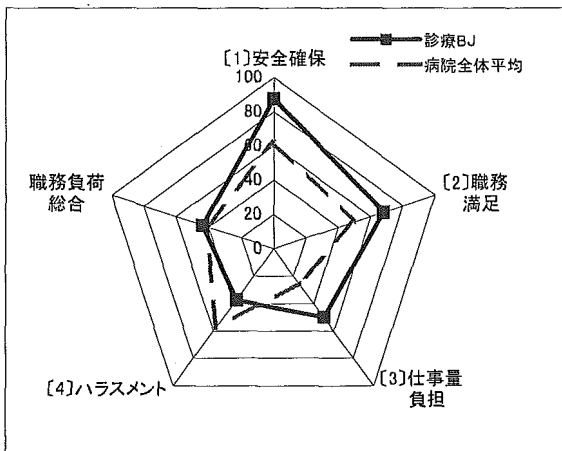
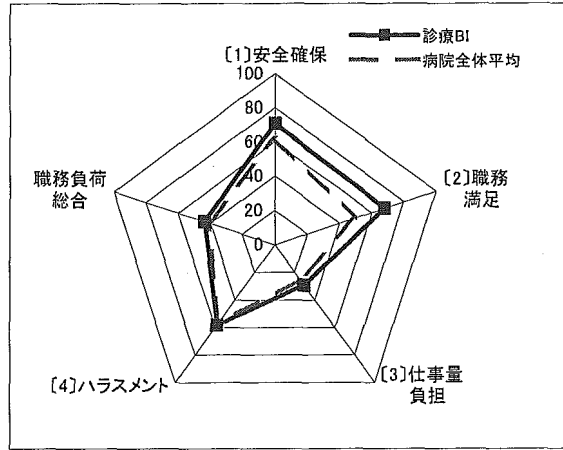
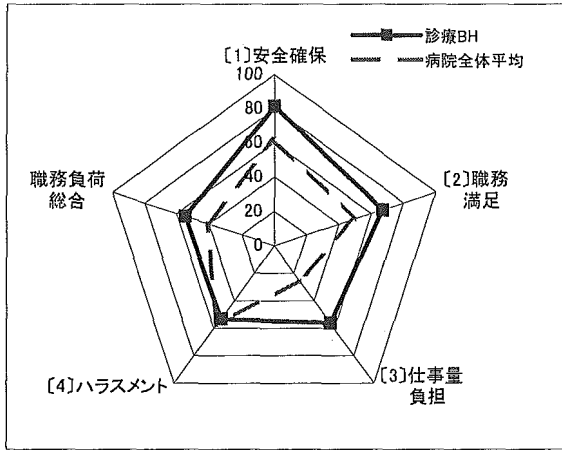
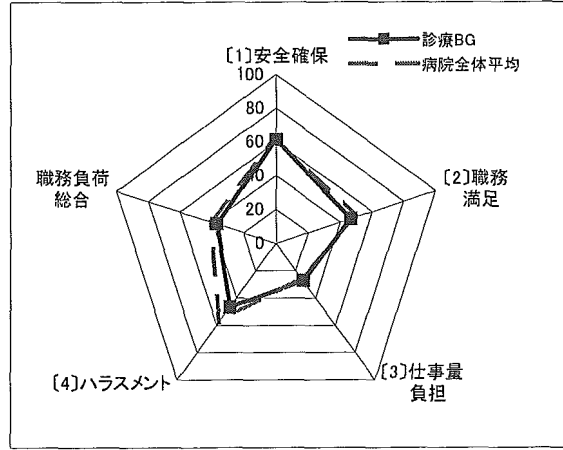
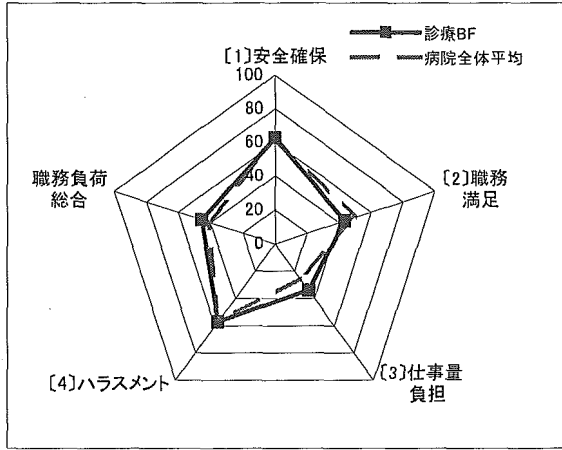
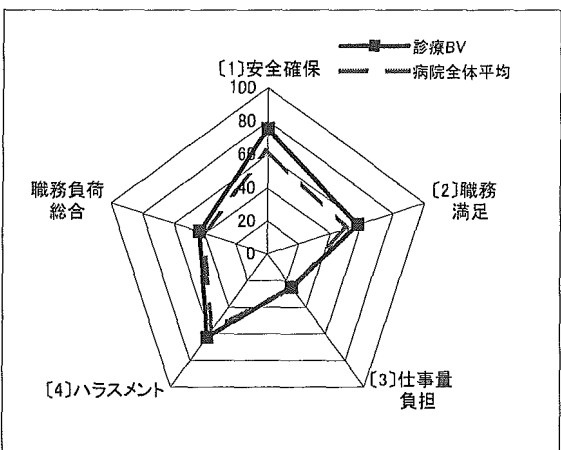
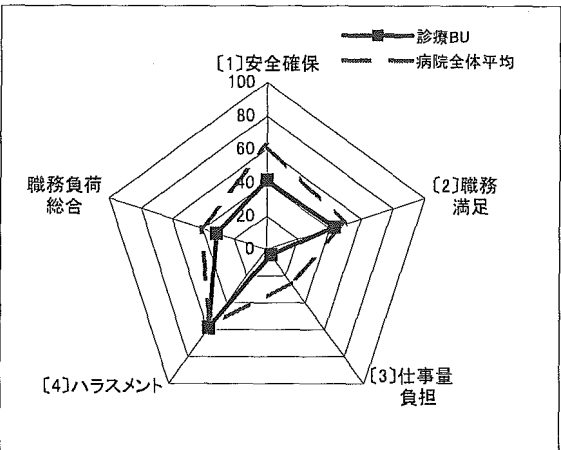
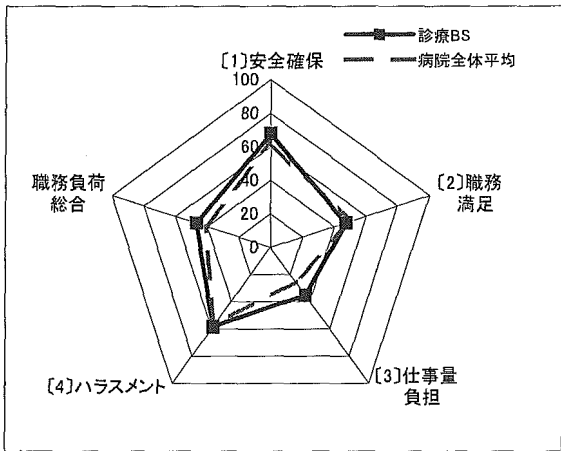
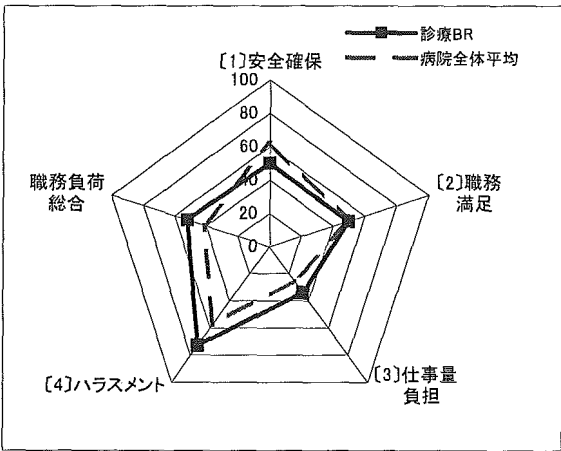
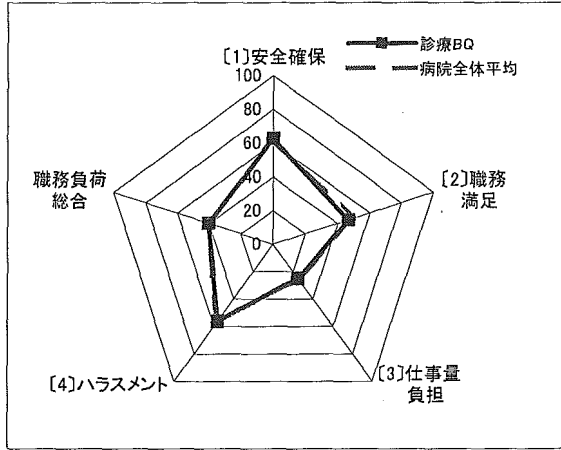
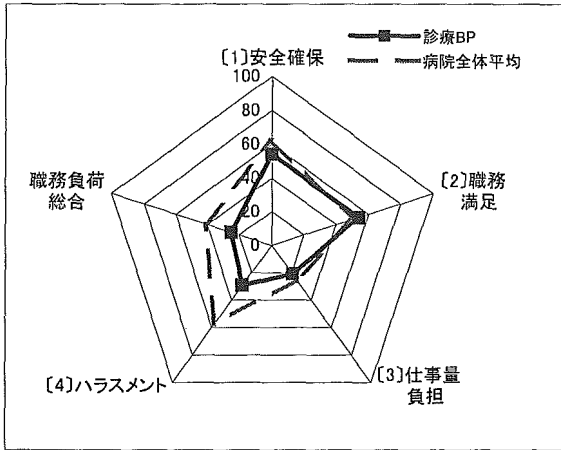
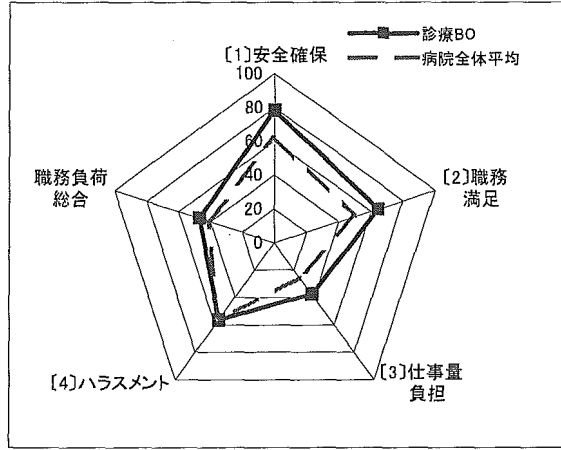
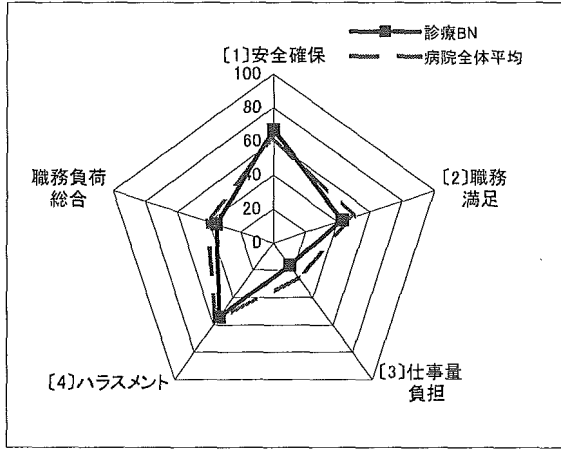

# 診療科間比較

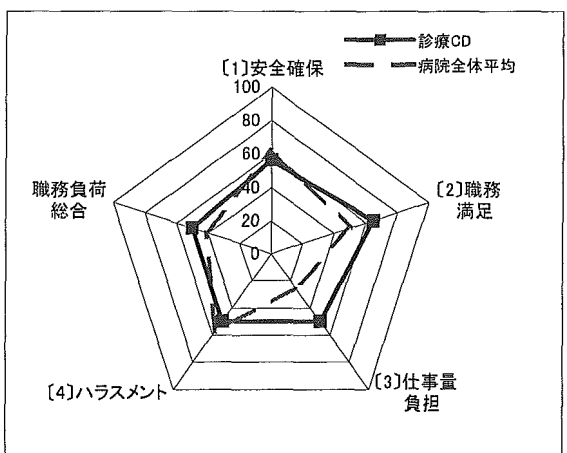
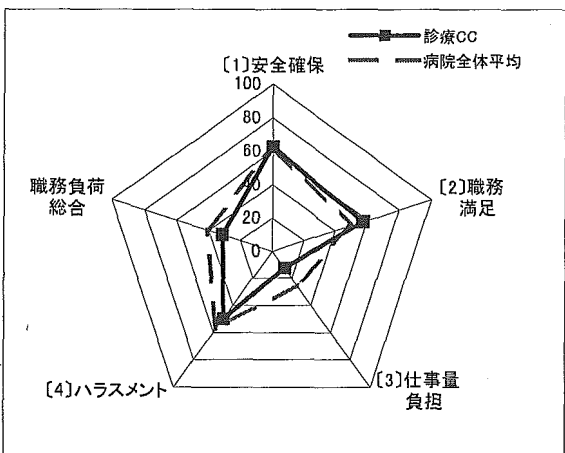
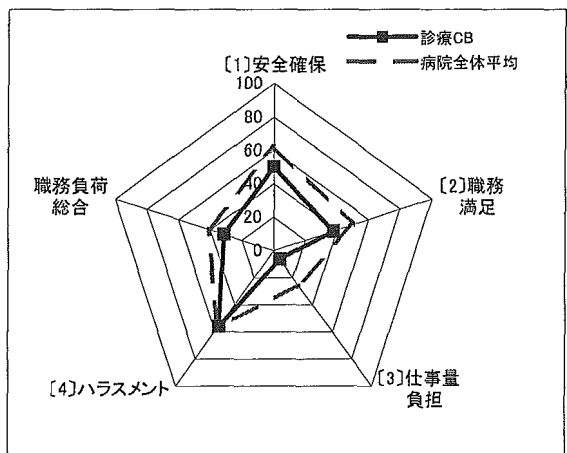
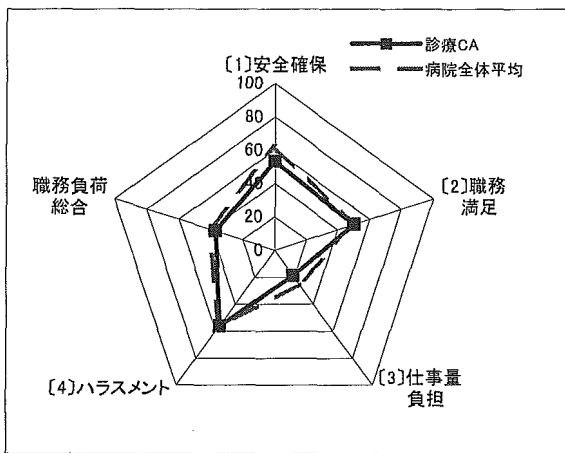
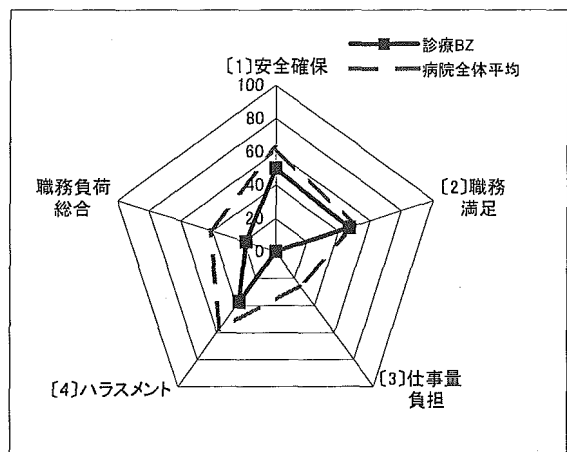
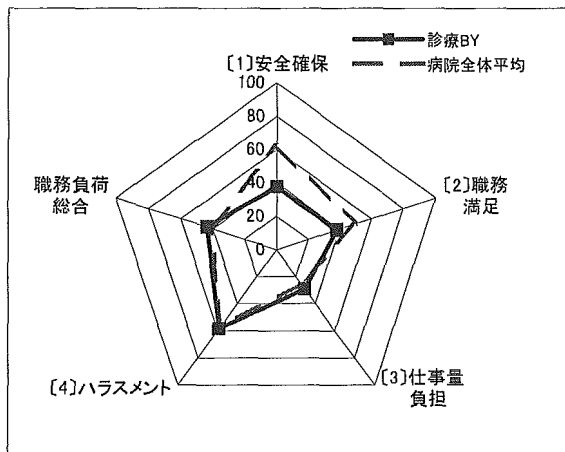
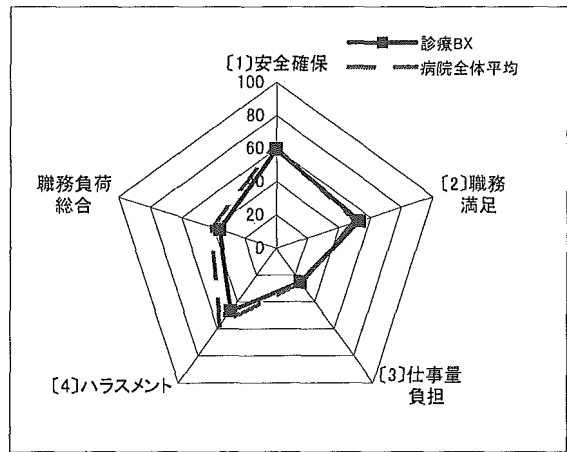
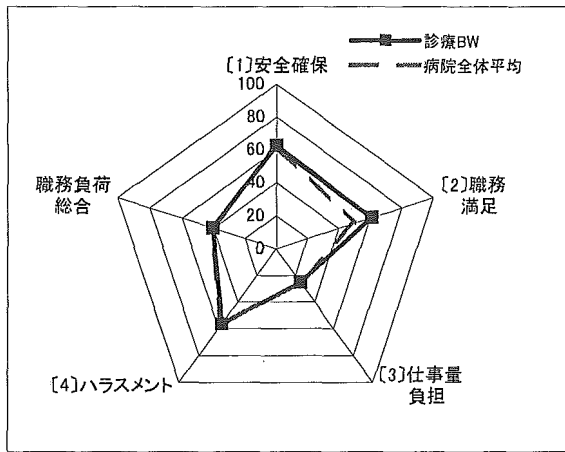

# 診療科間比較

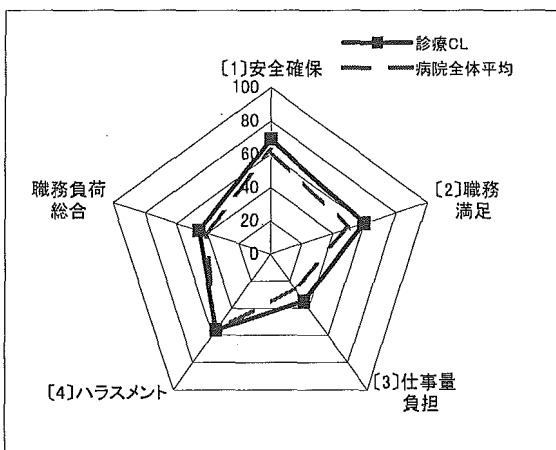
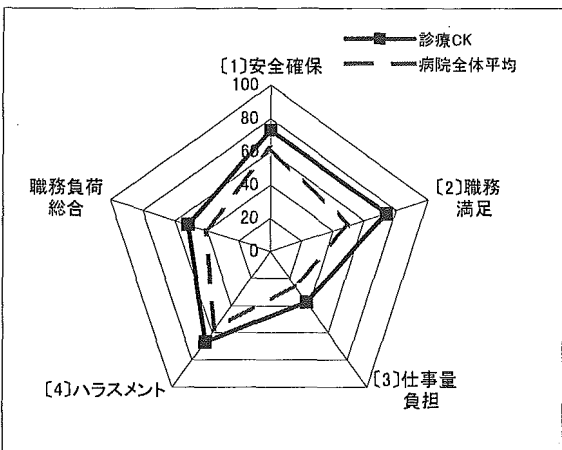
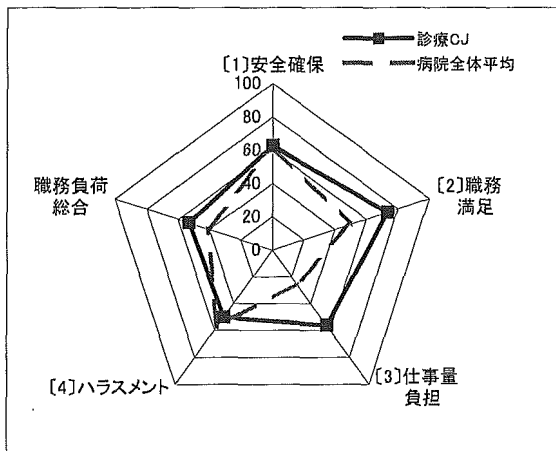
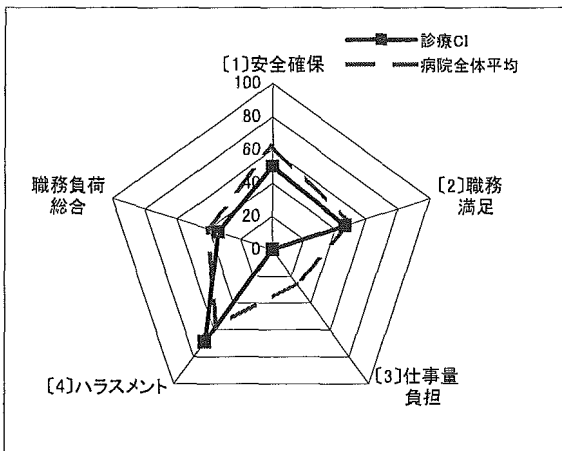
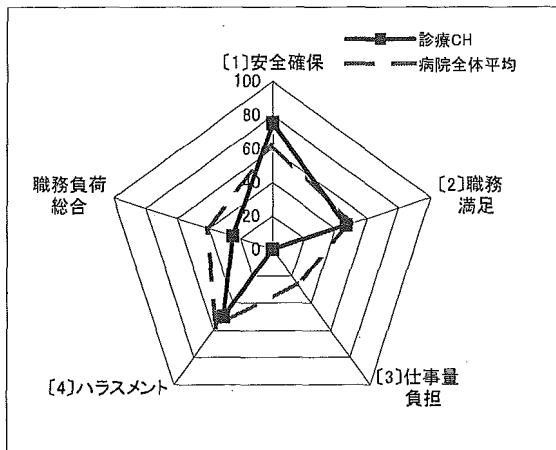
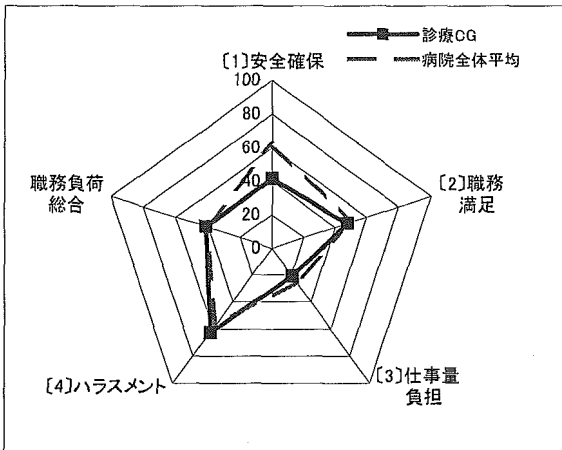
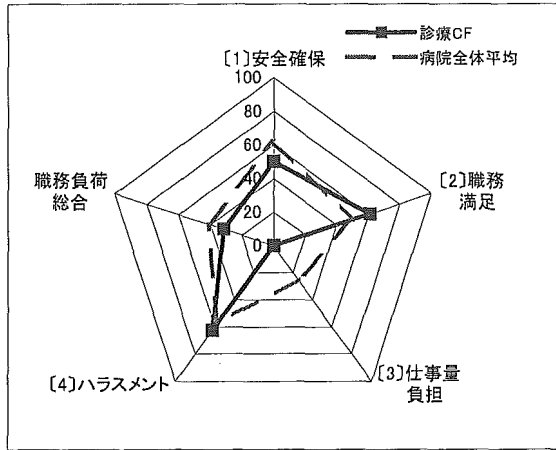
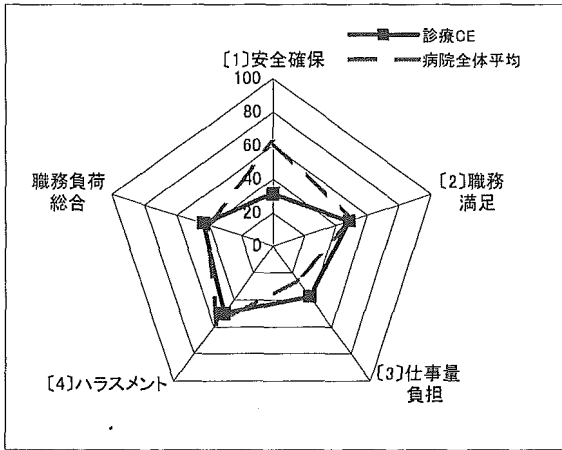

# 診療科間比較

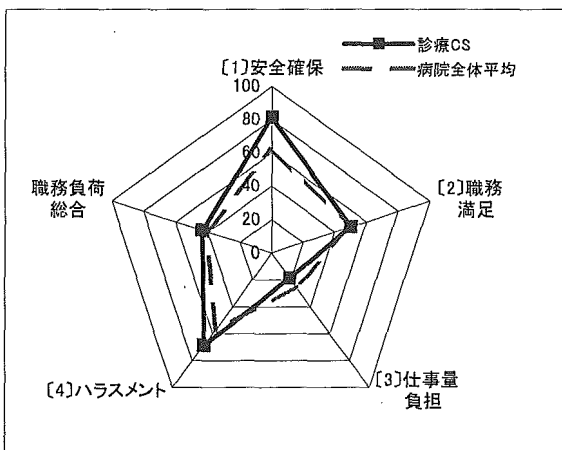
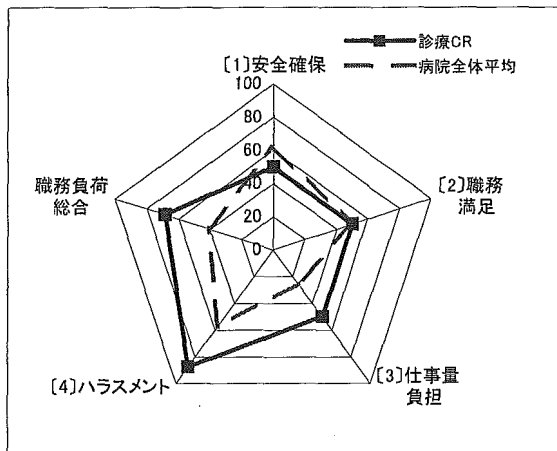
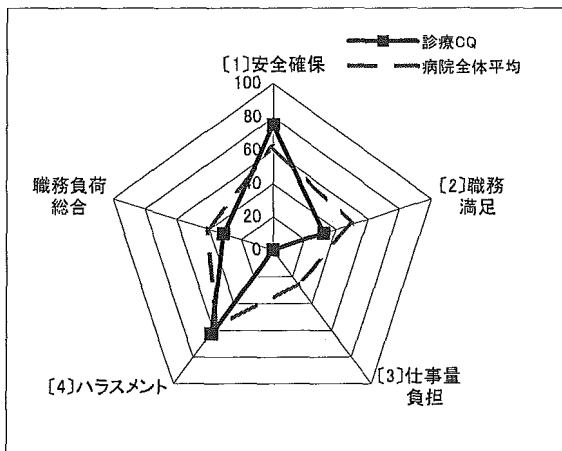
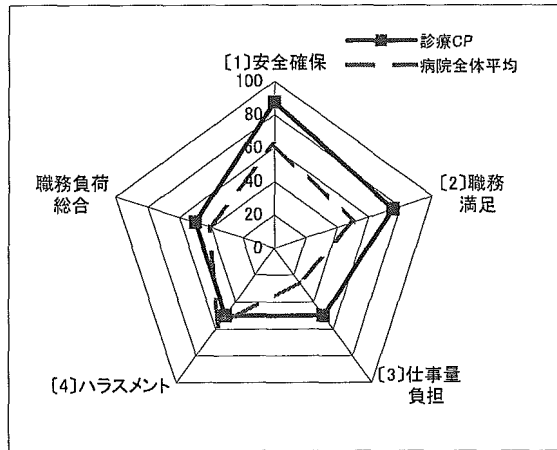
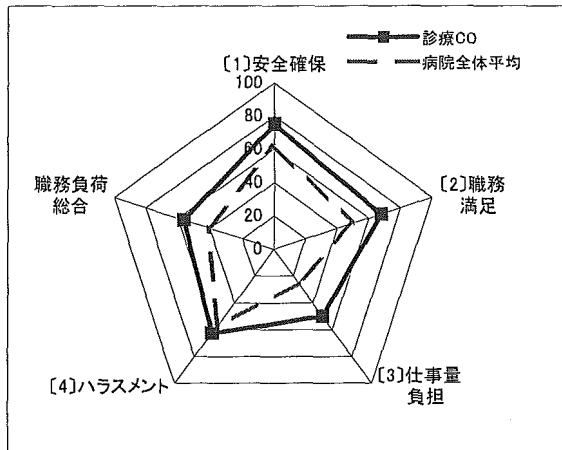
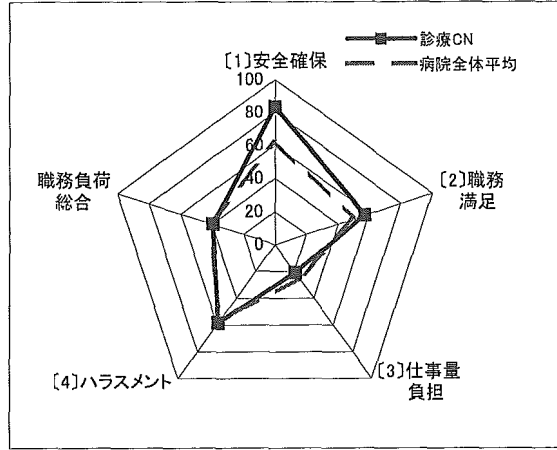
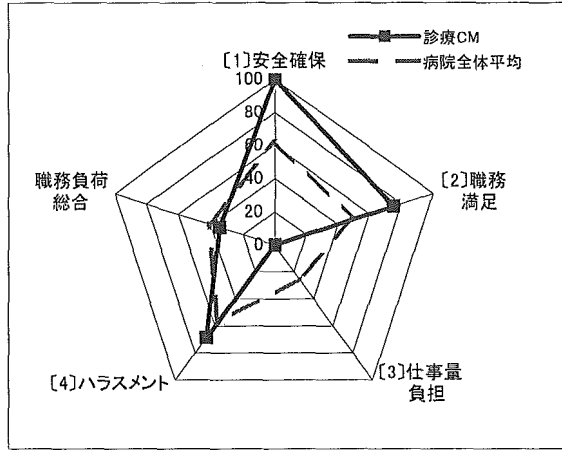

# ■ 病棟間比較

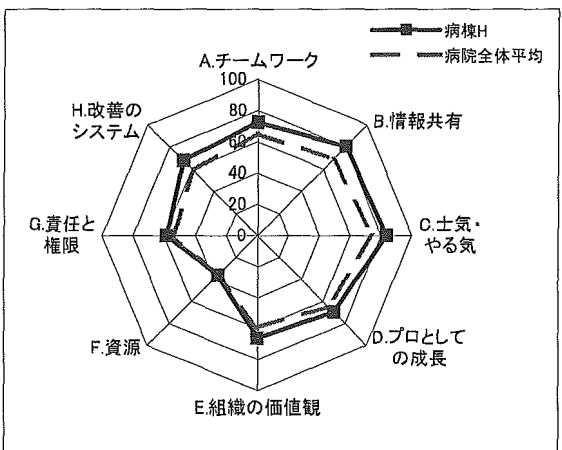
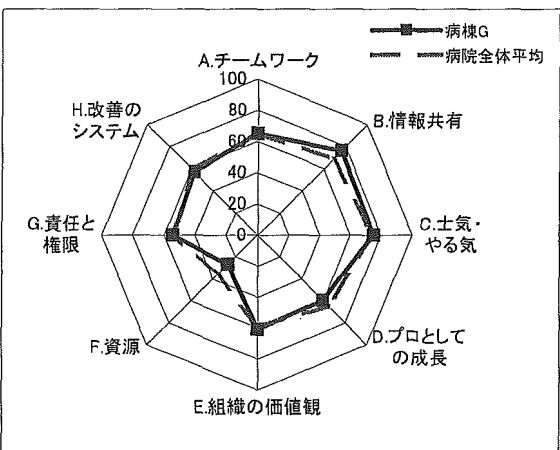
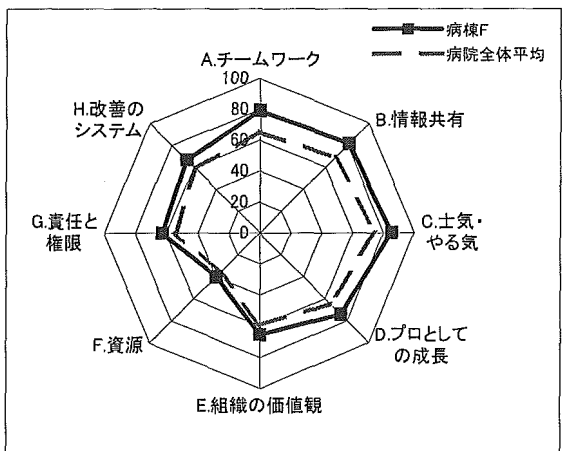
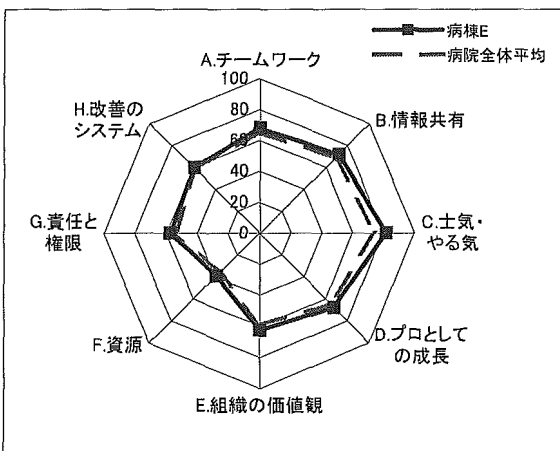
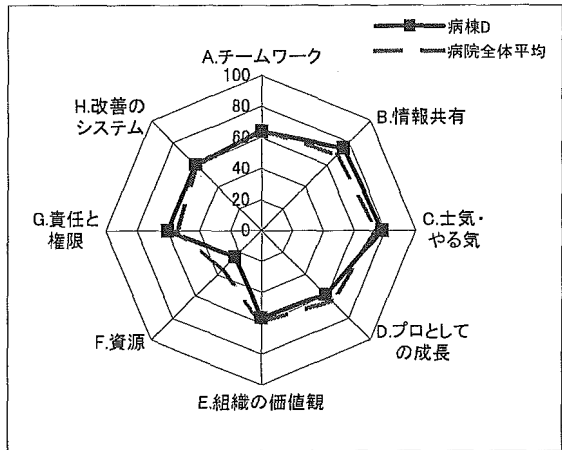
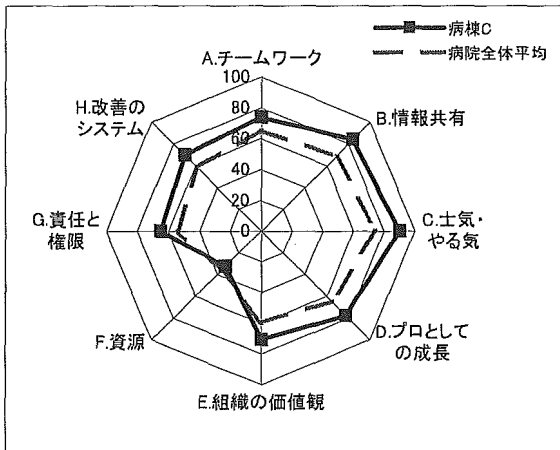
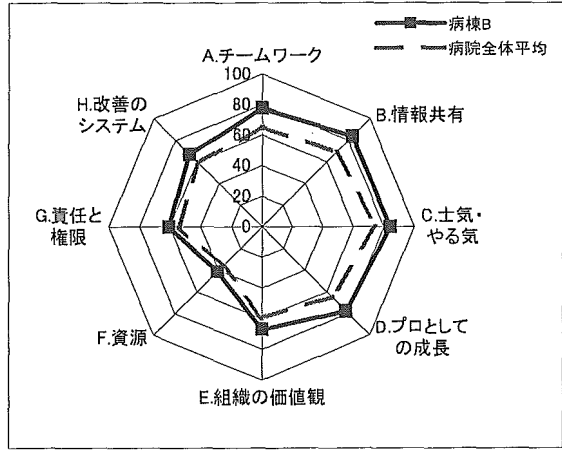
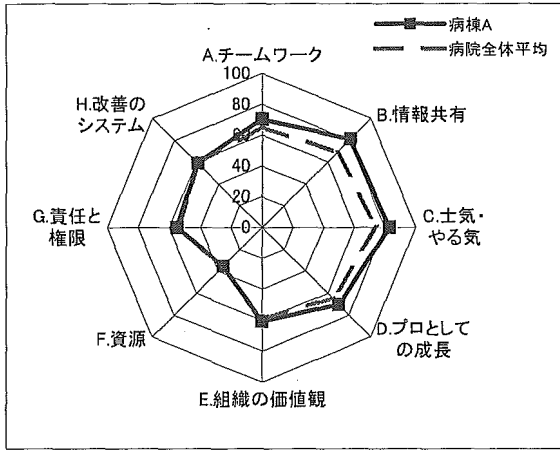

# ■ 病棟間比較

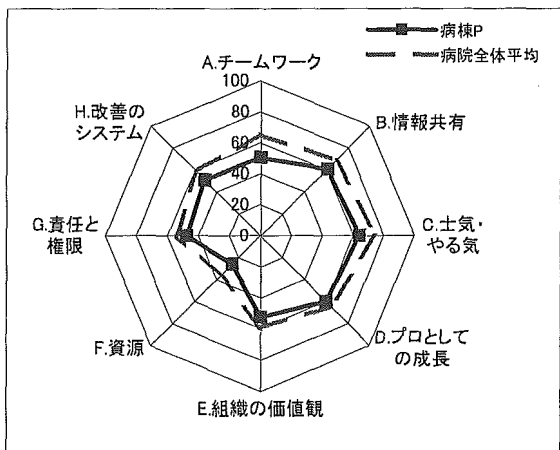
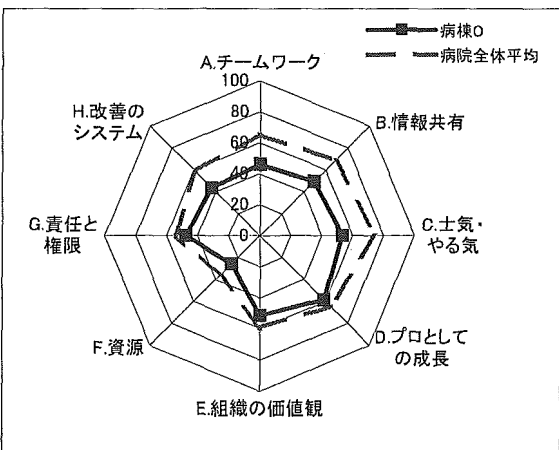
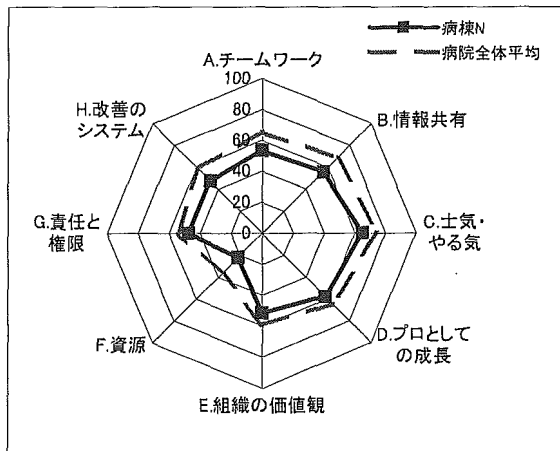
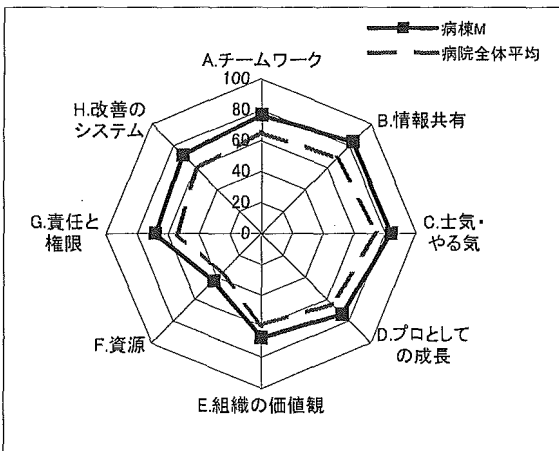
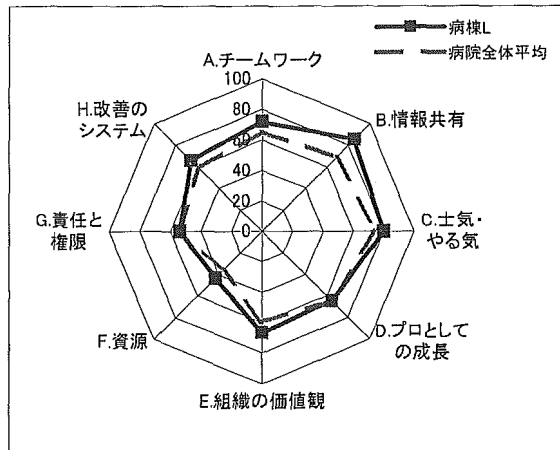
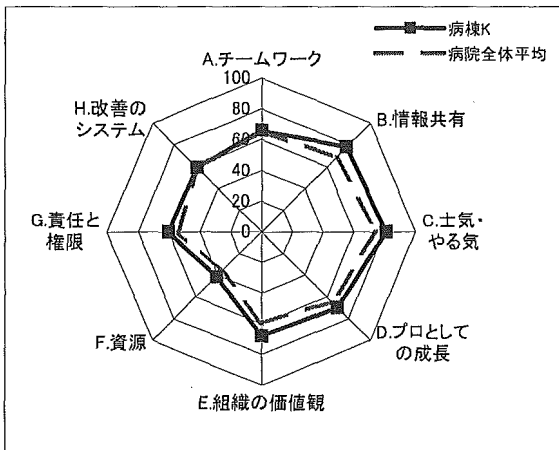
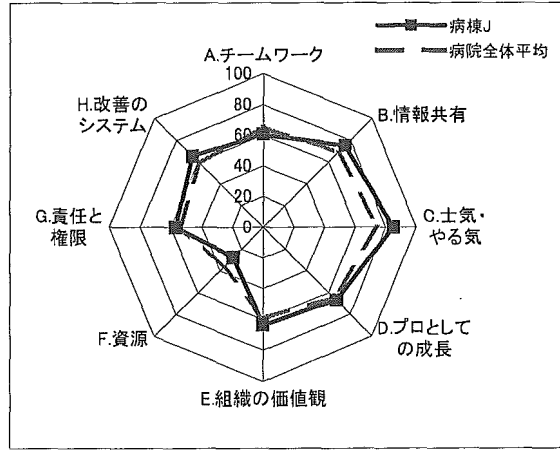
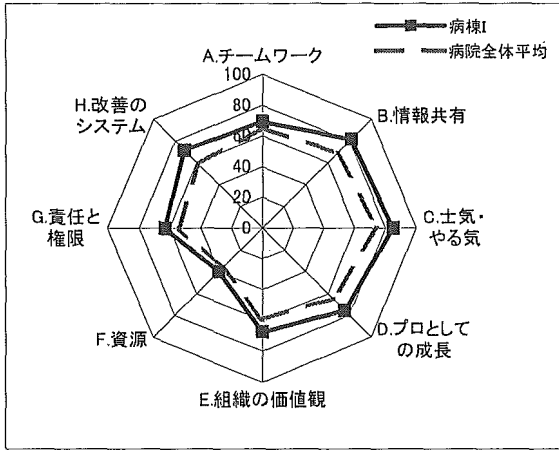



# ■ 病棟間比較

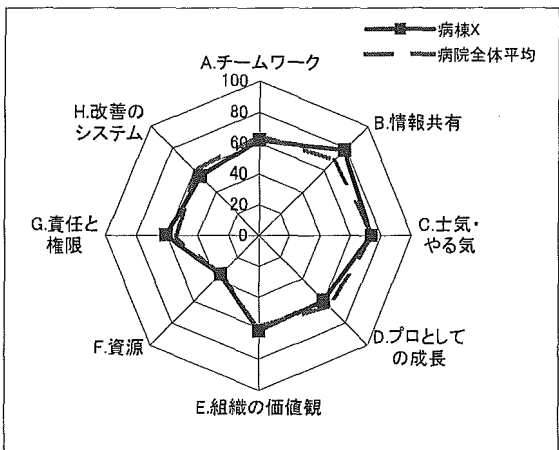
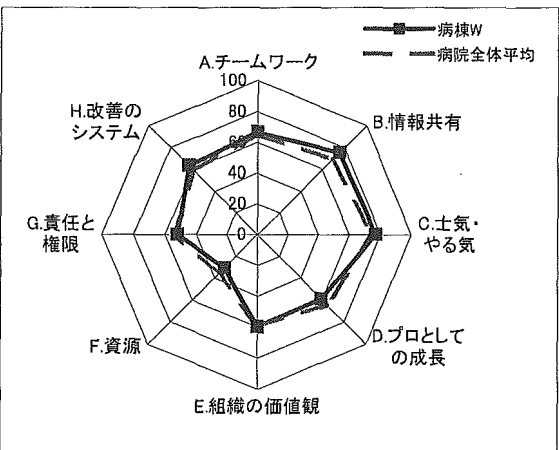
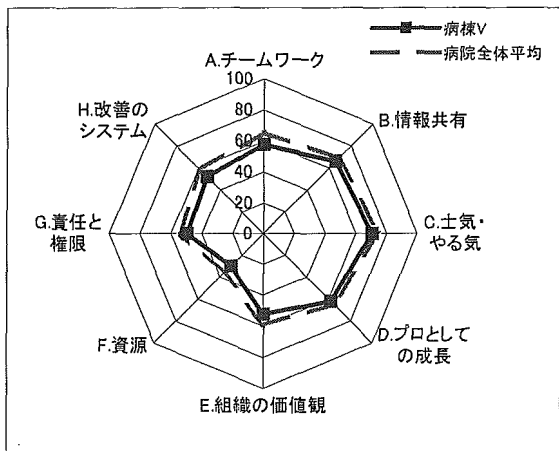
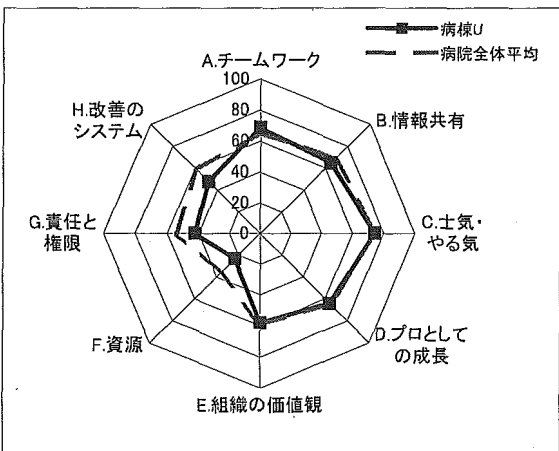
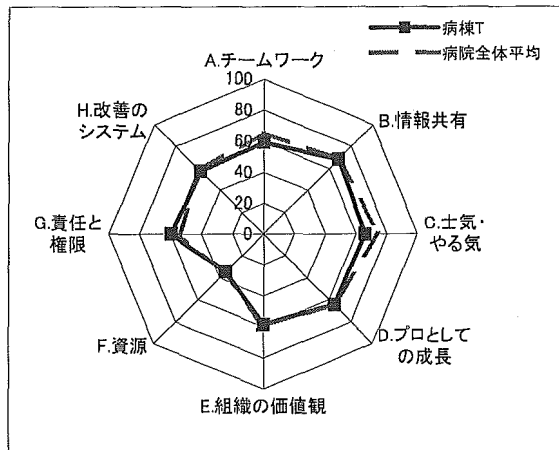
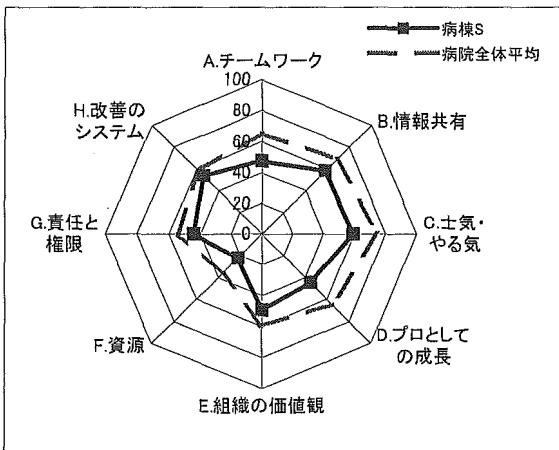
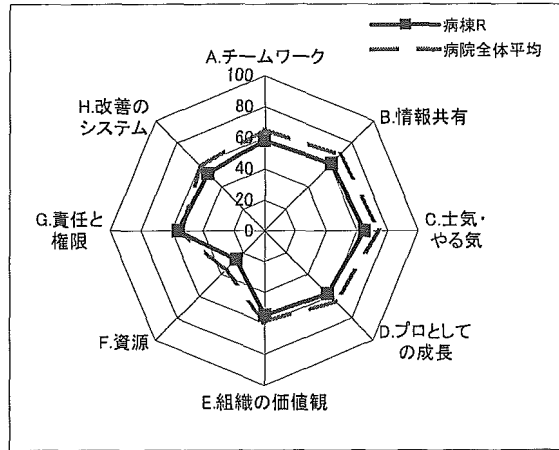
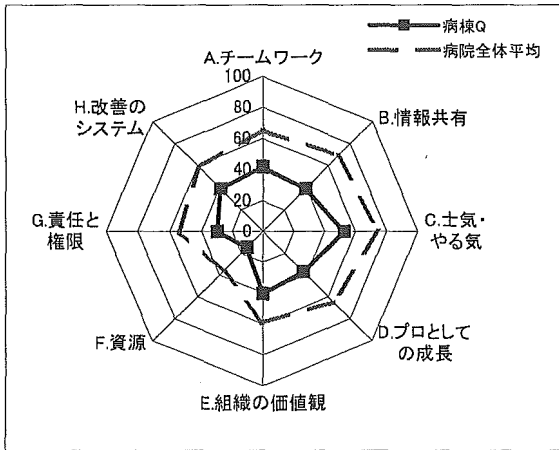

# ■ 病棟間比較

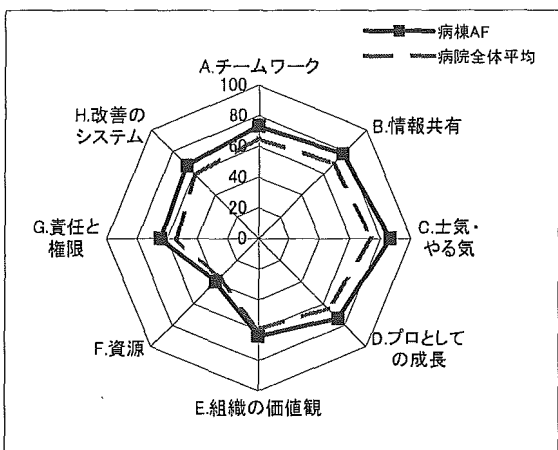
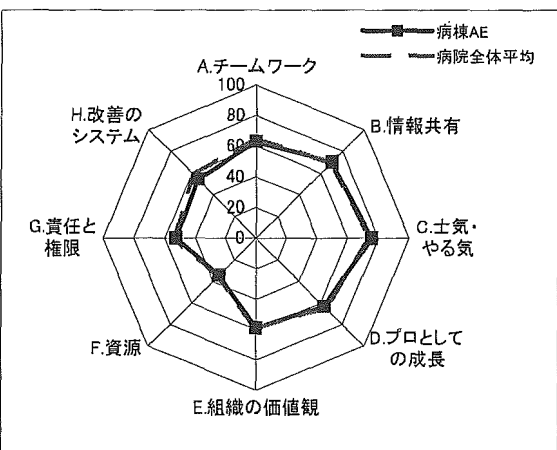
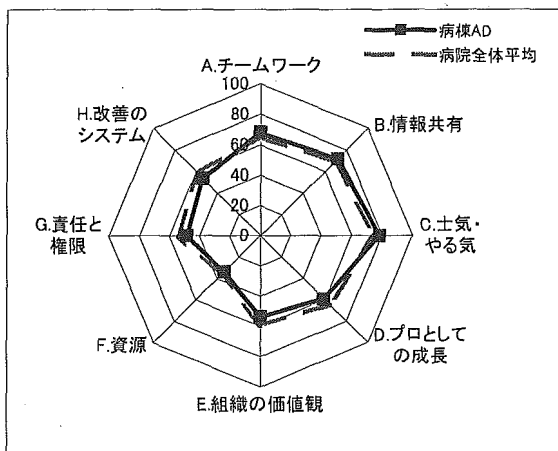
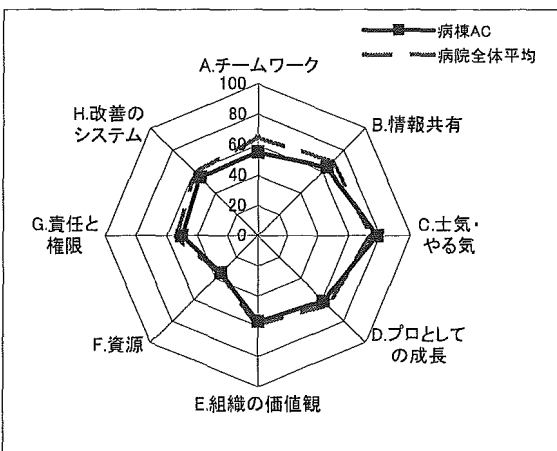
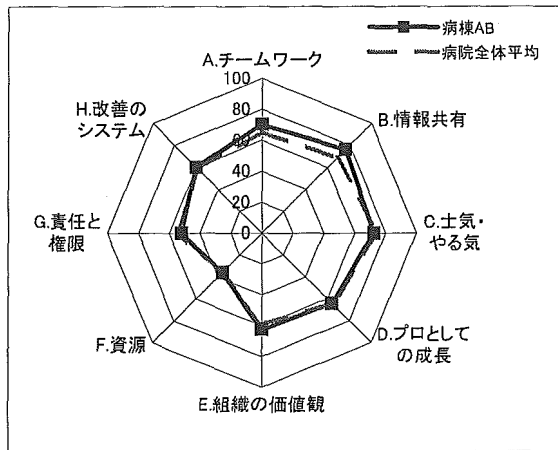
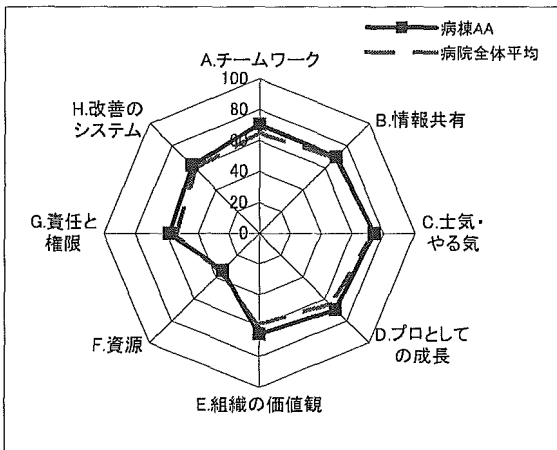
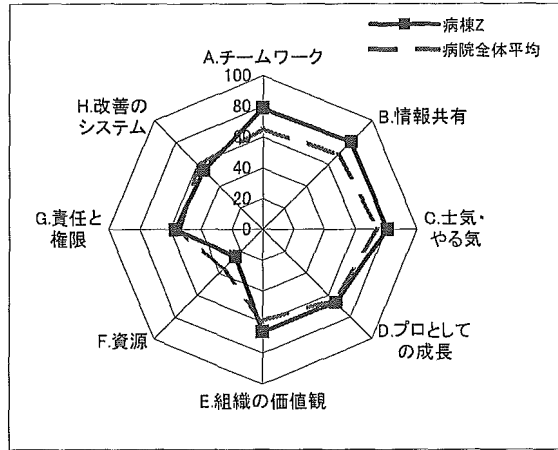
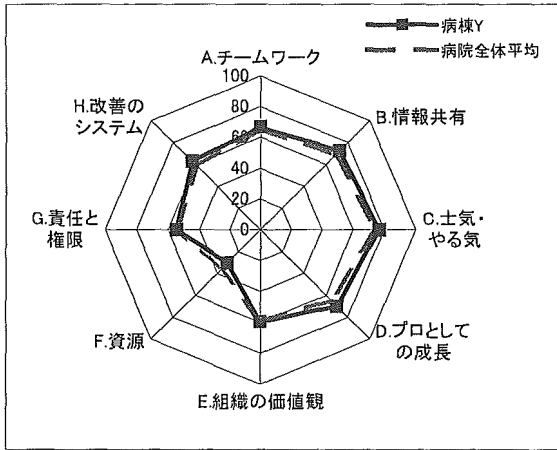

# ■ 病棟間比較

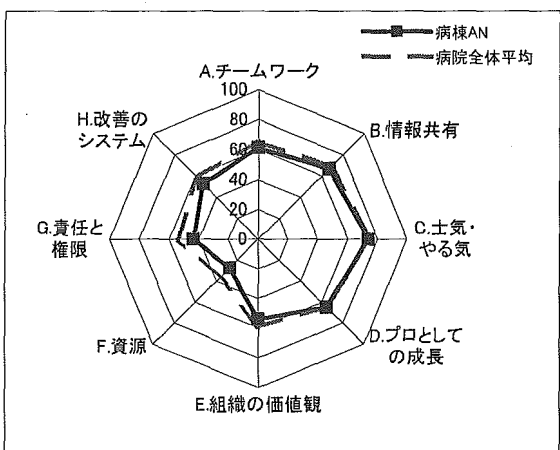
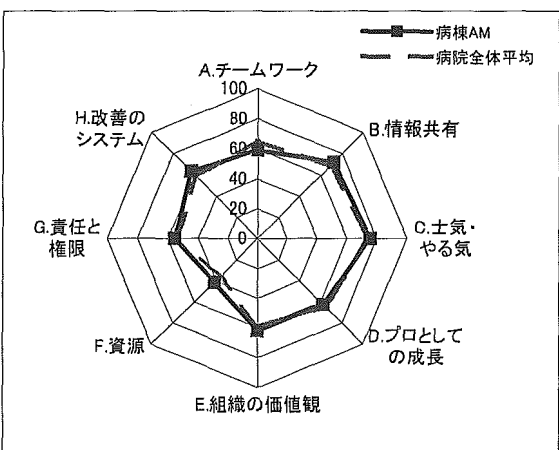
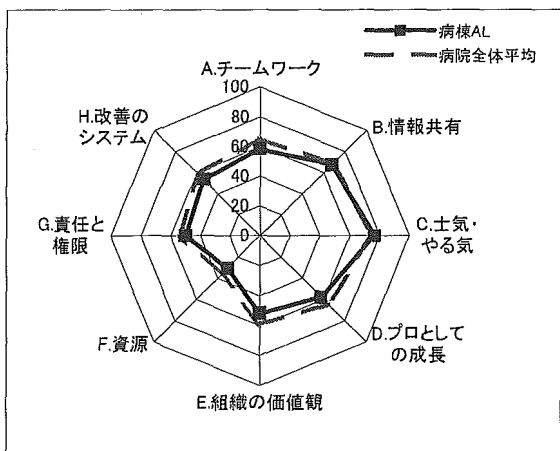
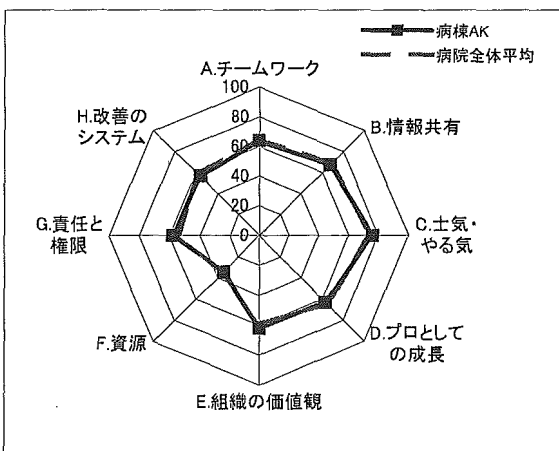
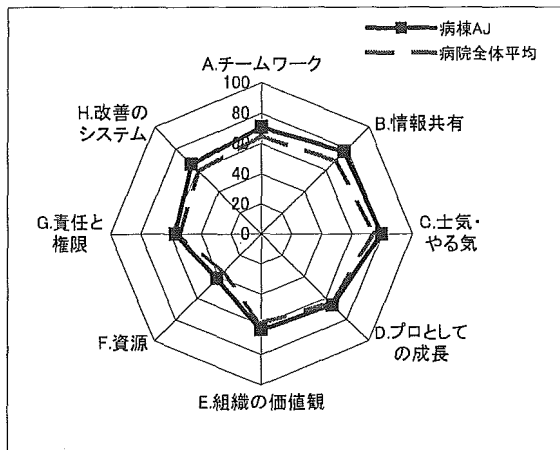
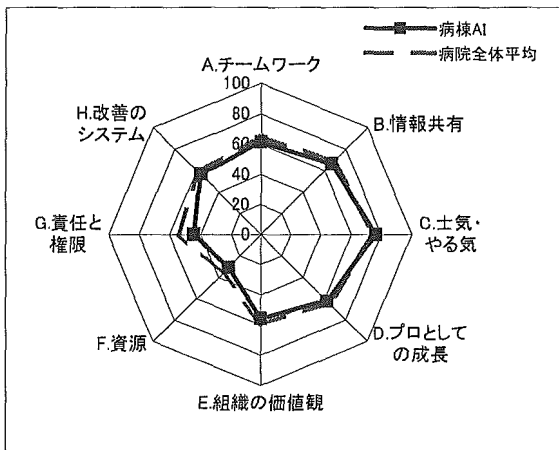
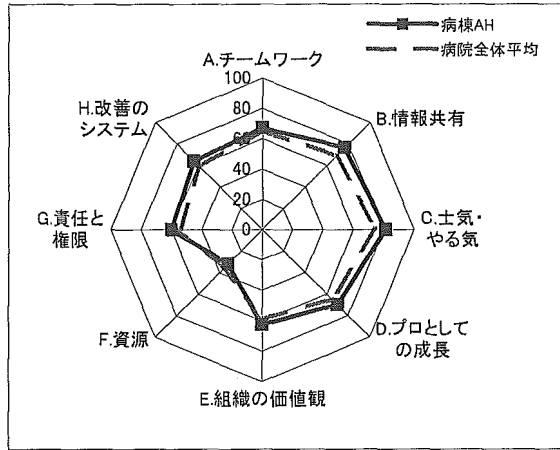
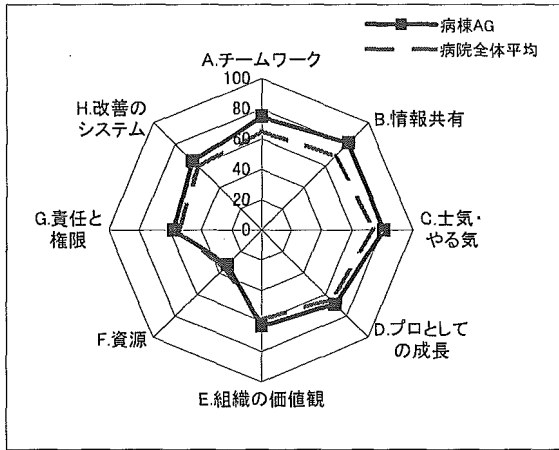

# ■ 病棟間比較

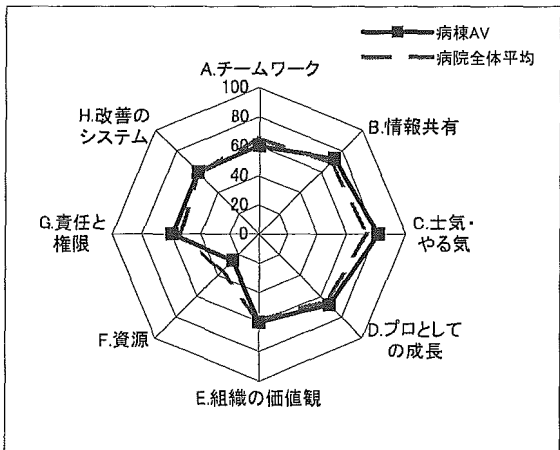
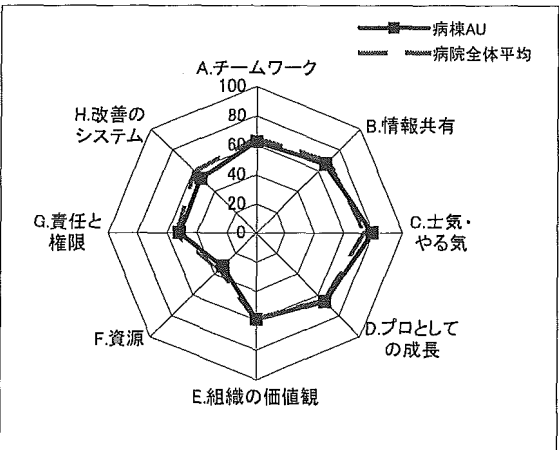
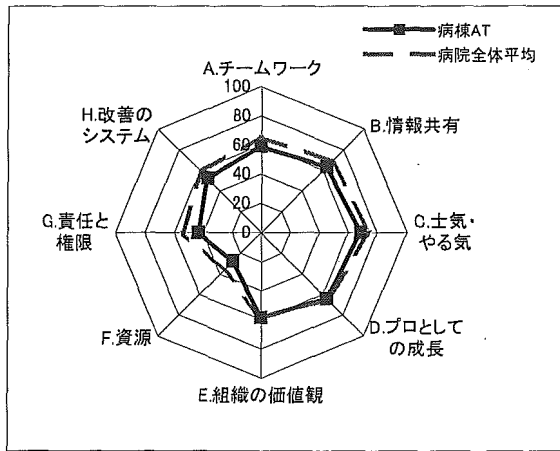
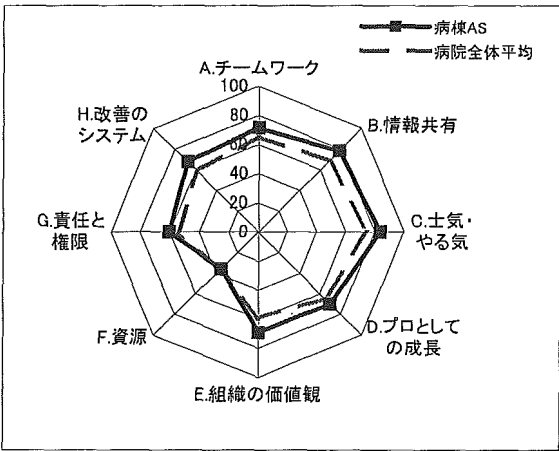
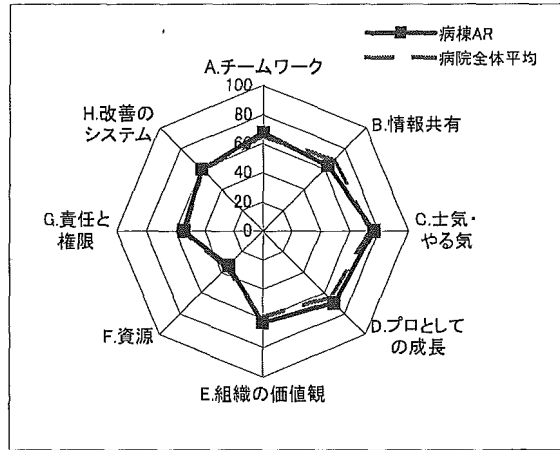
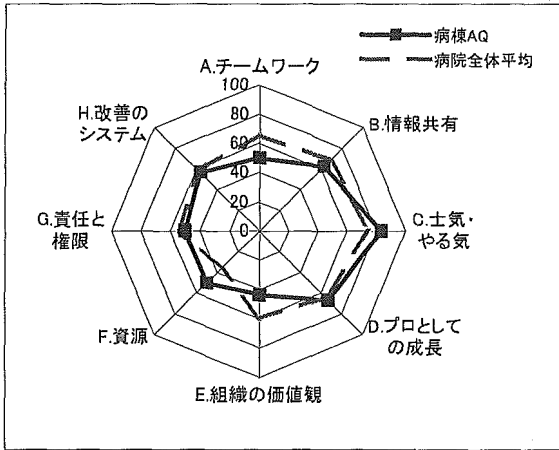
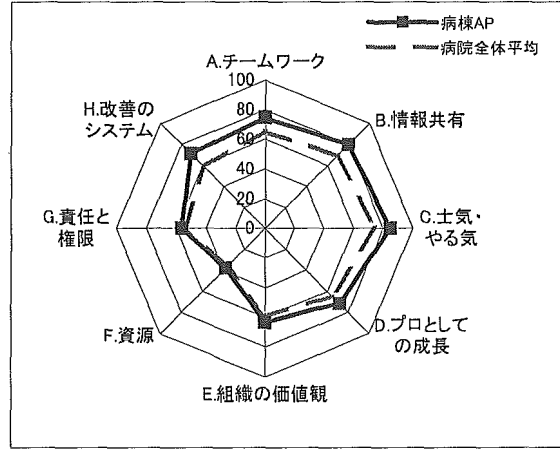
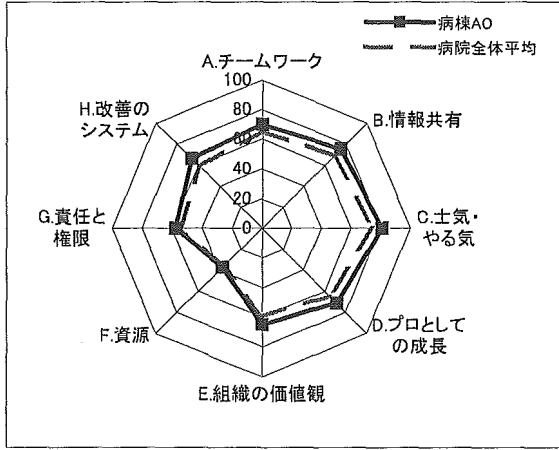

# ■ 病棟間比較

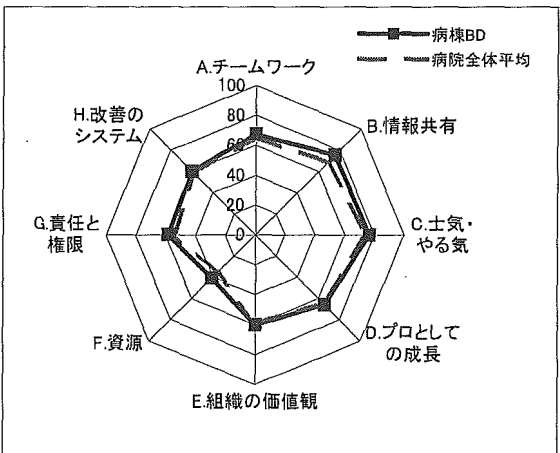
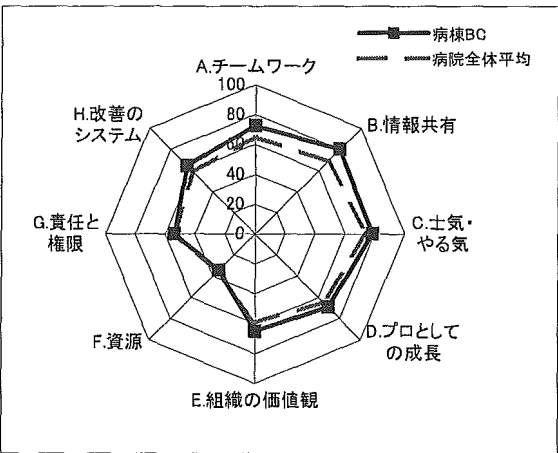
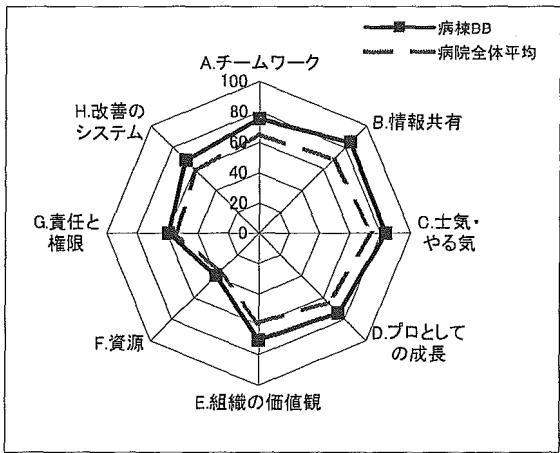
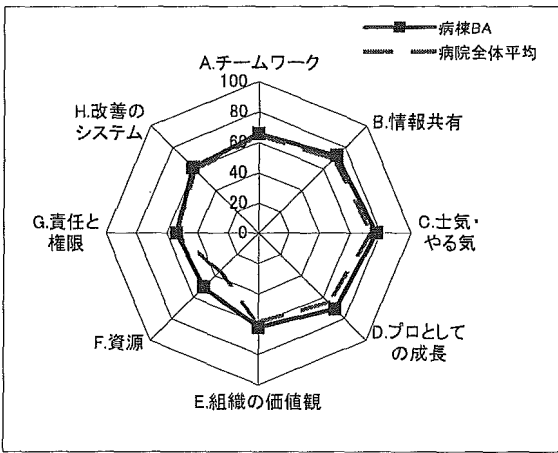
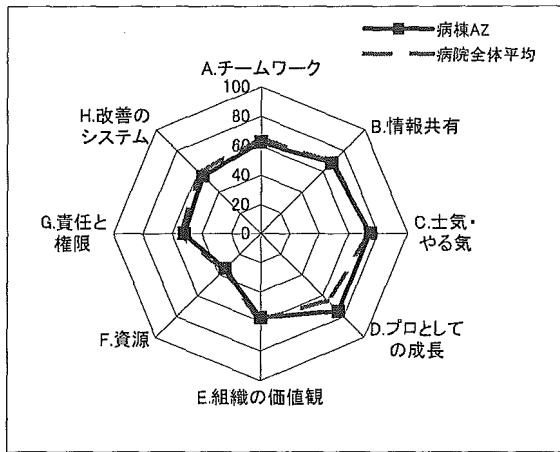
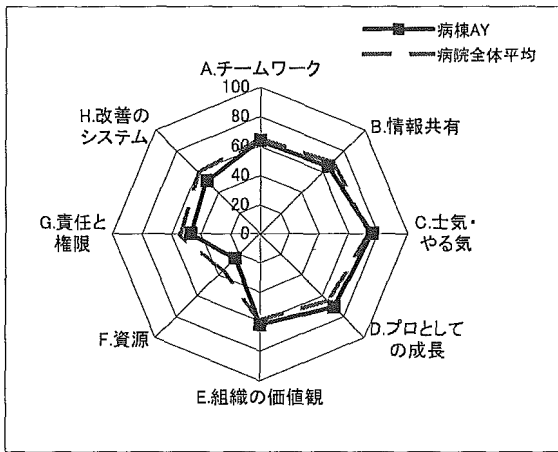
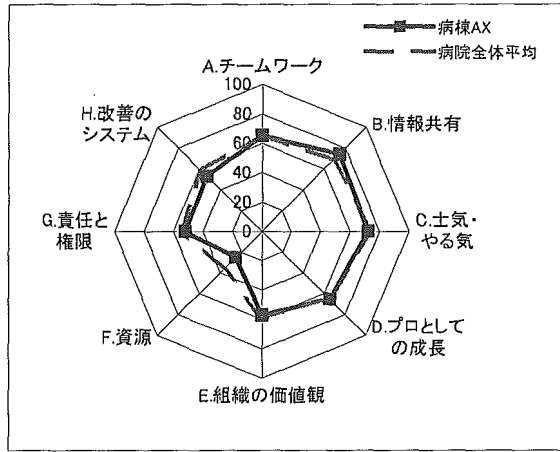
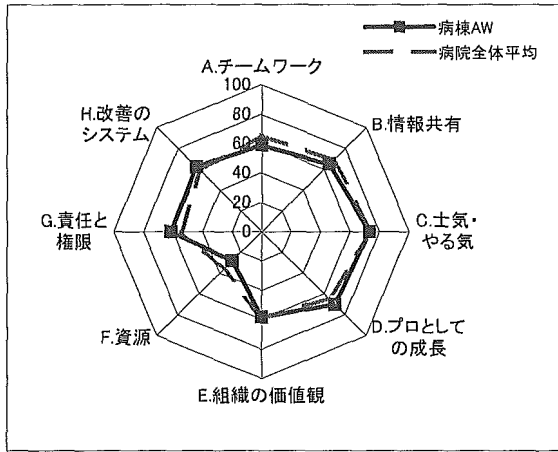

# ■ 病棟間比較

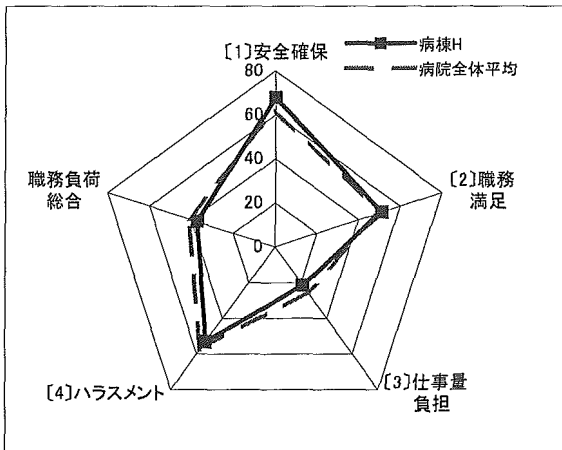
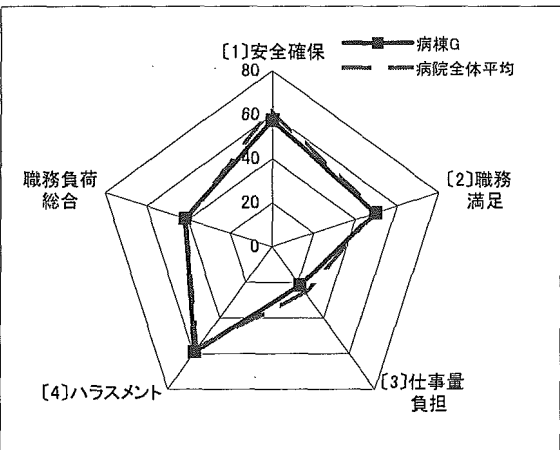
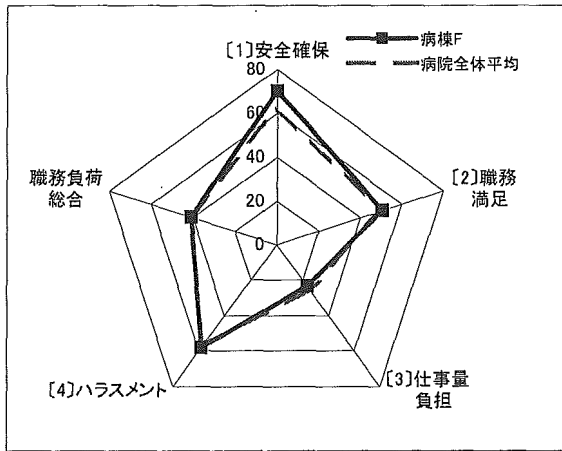
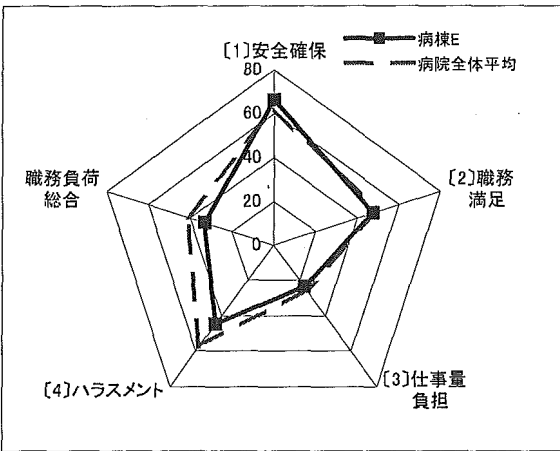
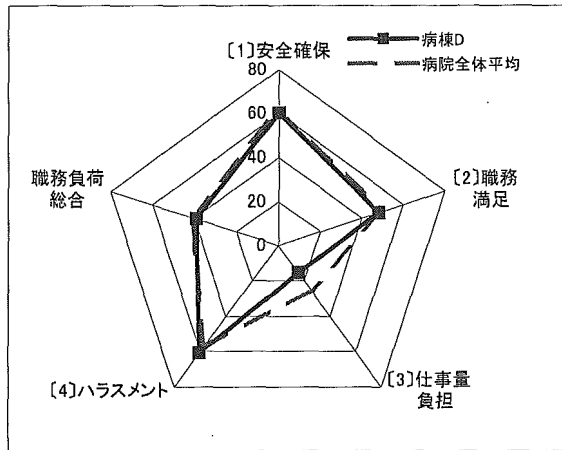
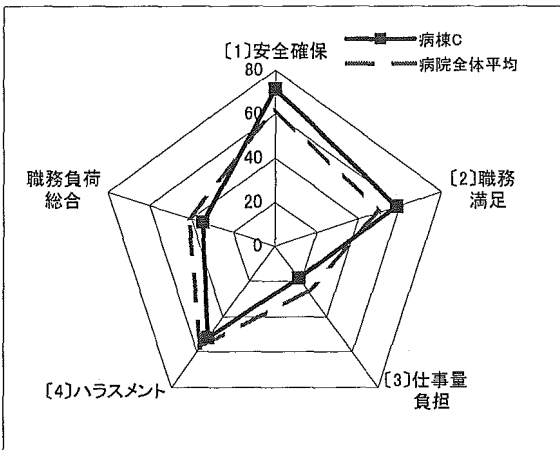
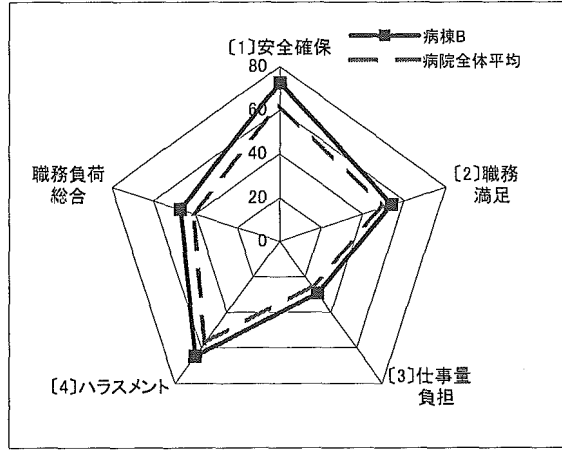
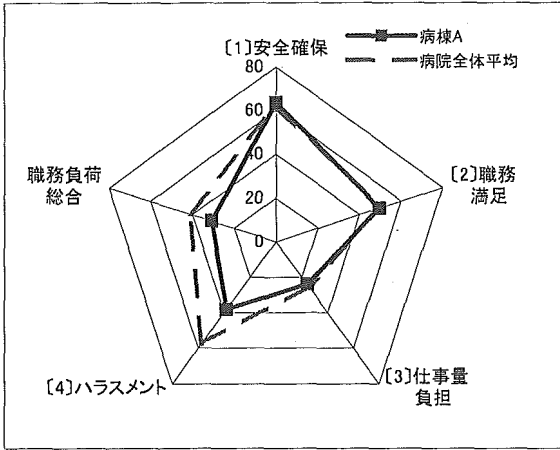

# ■ 病棟間比較

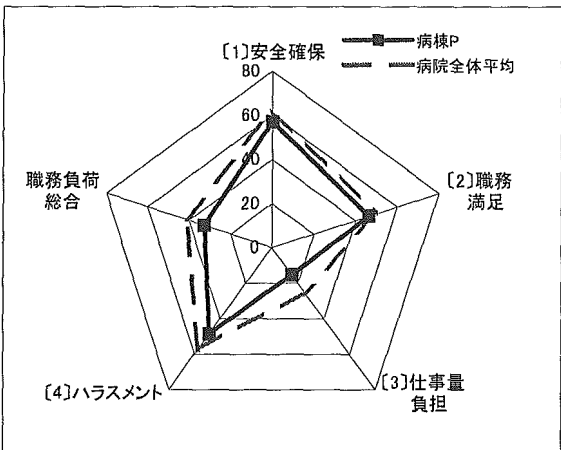
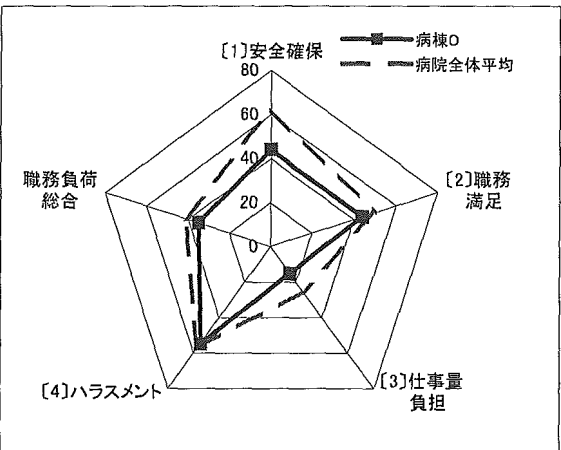
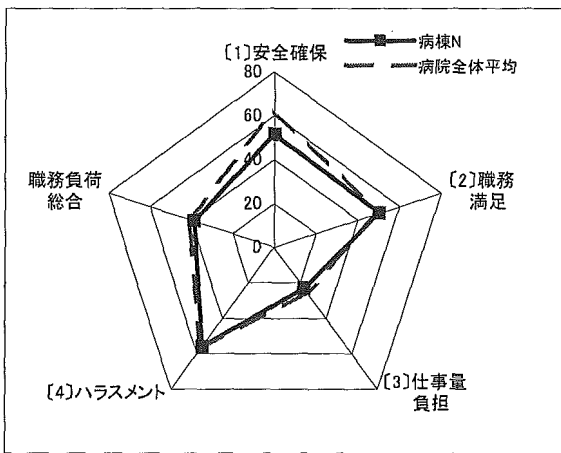
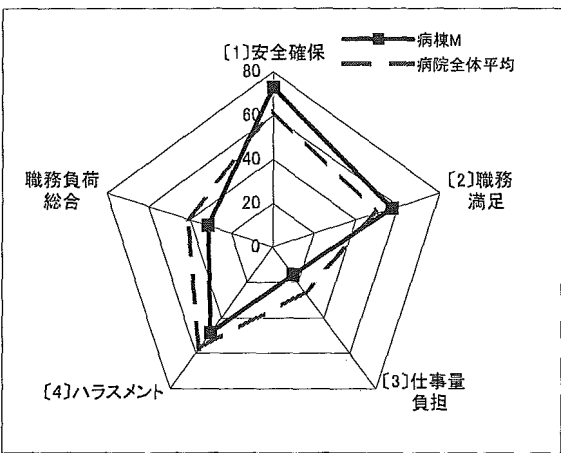
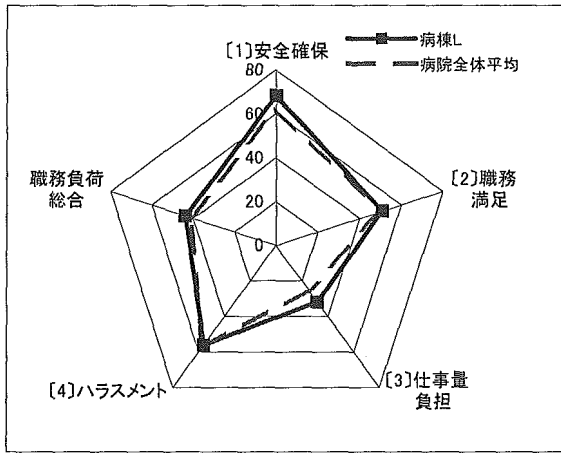
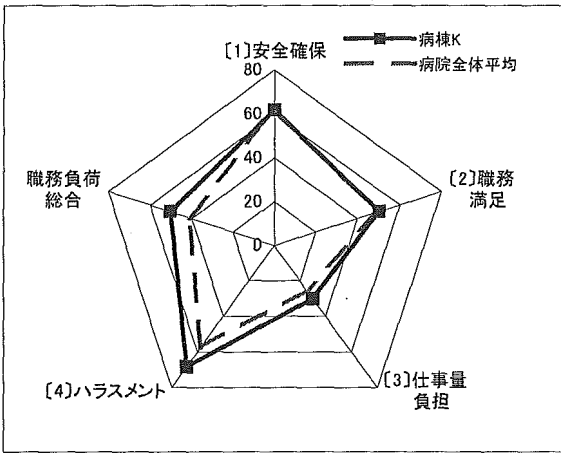
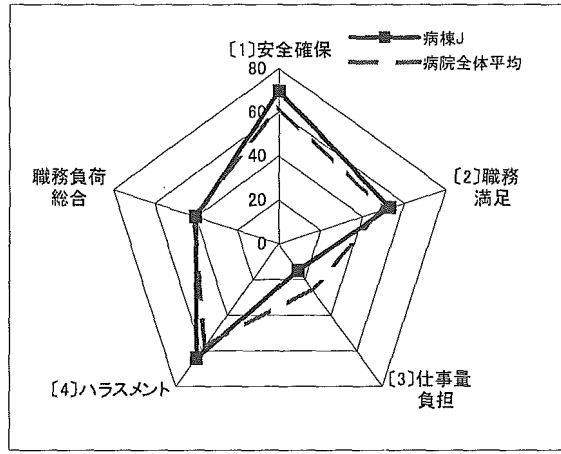
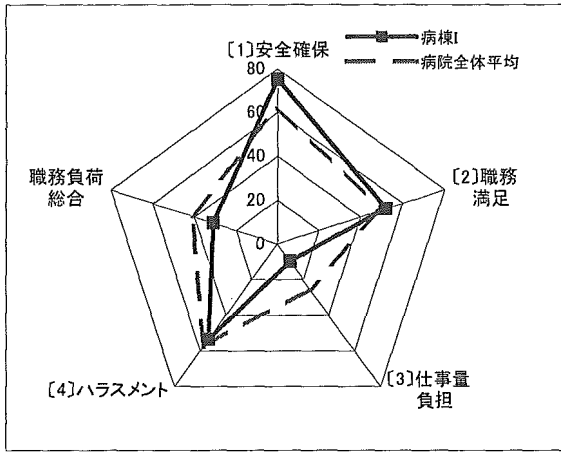

# ■ 病棟間比較

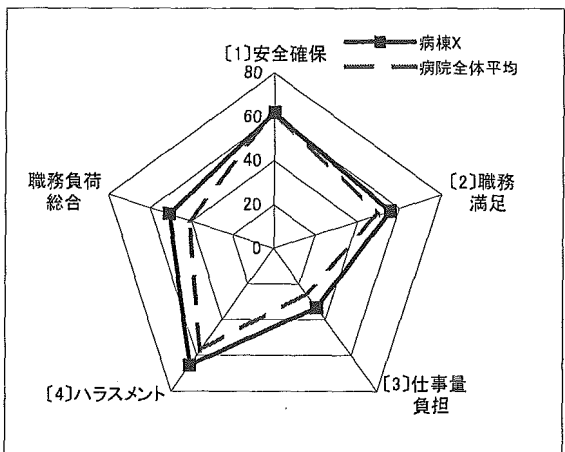
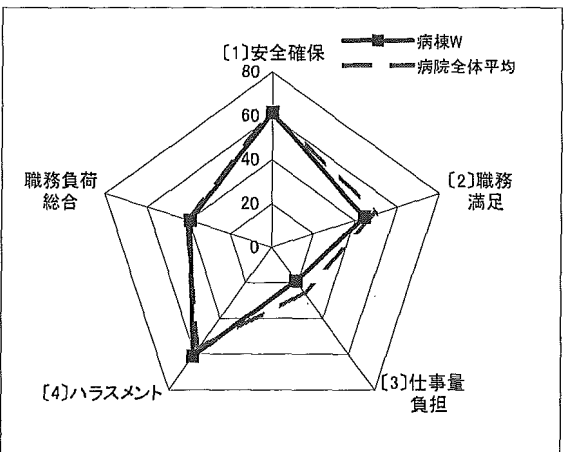
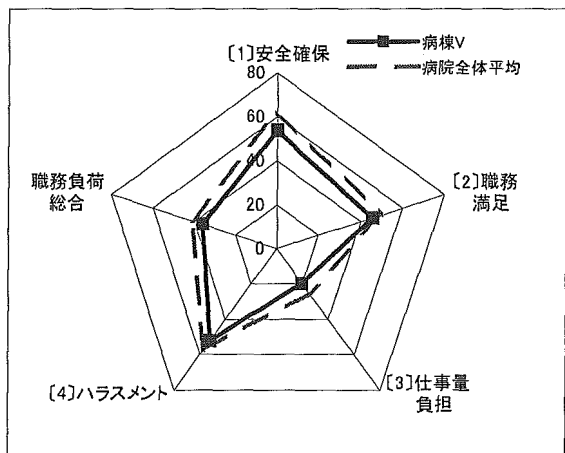
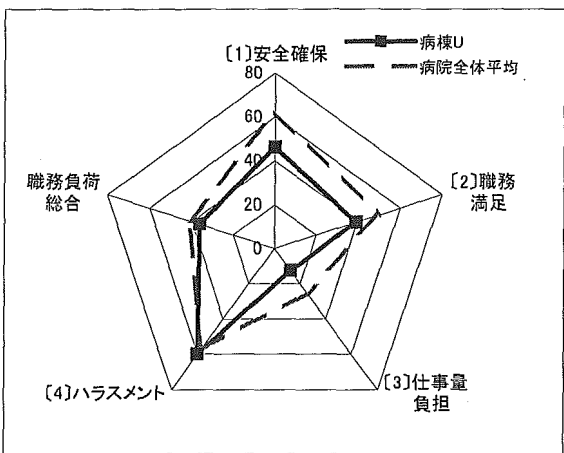
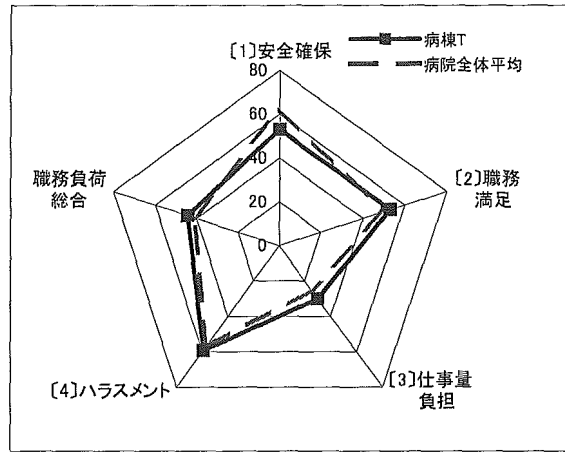
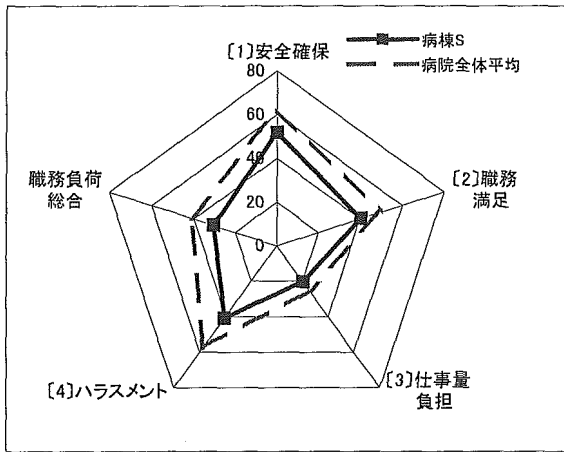
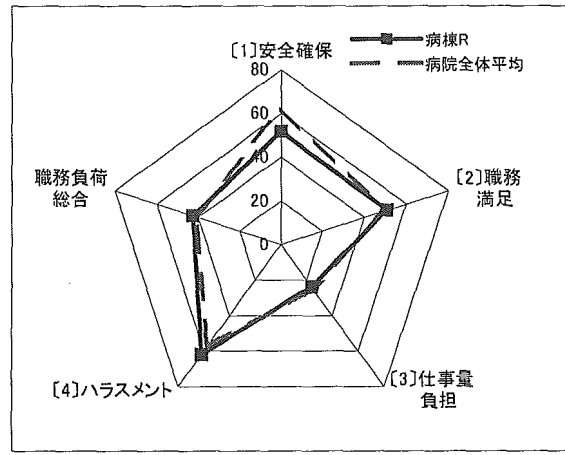
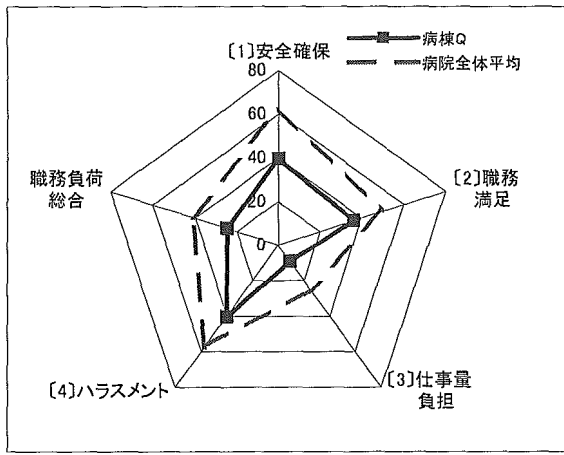



# ■ 病棟間比較

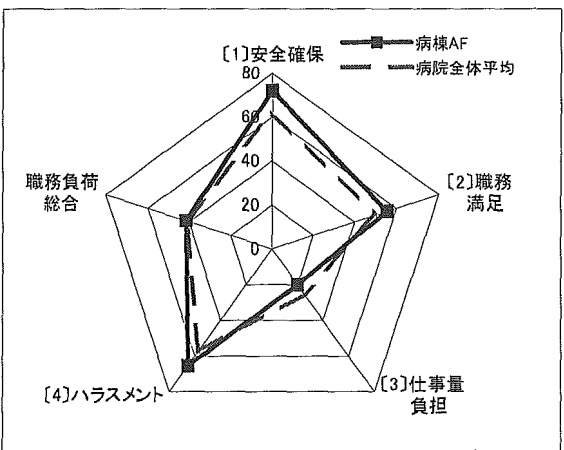
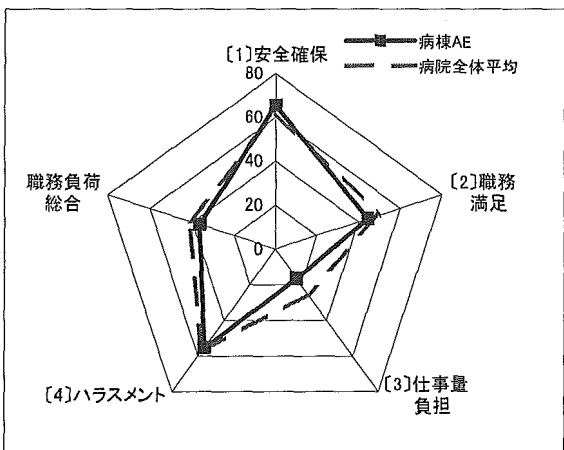
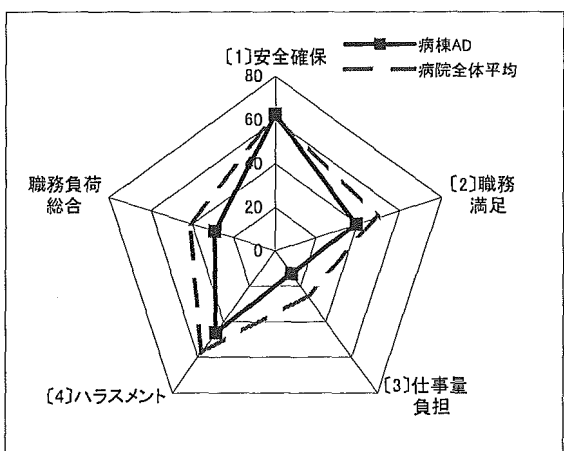
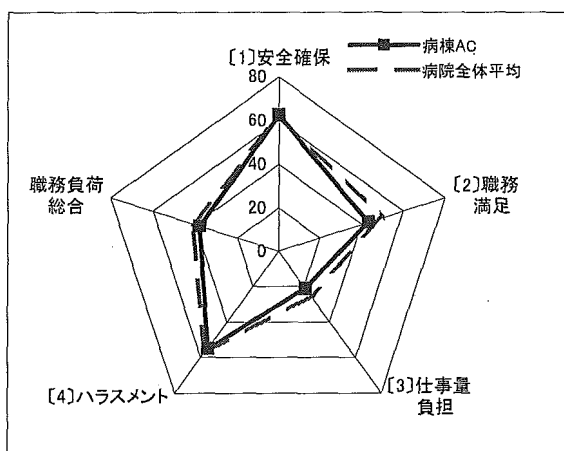
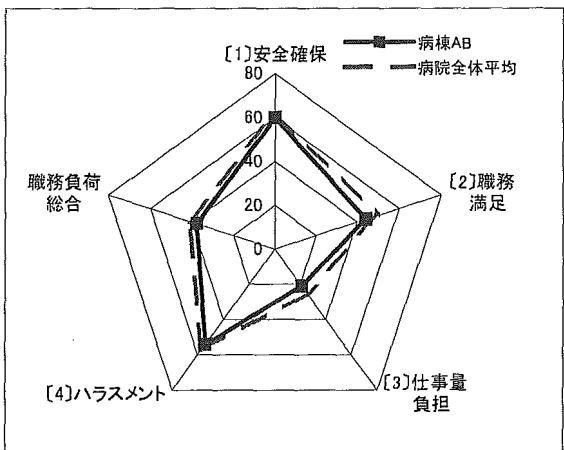
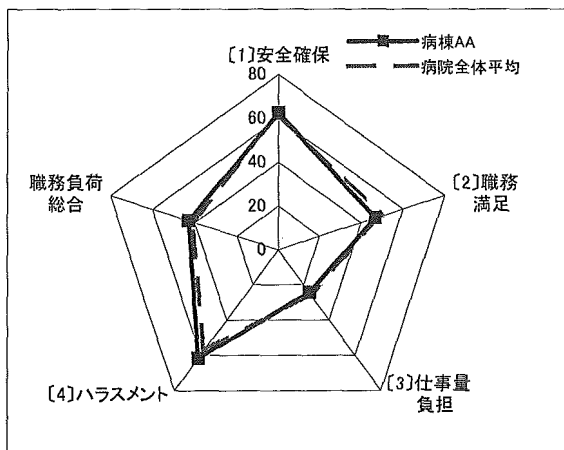
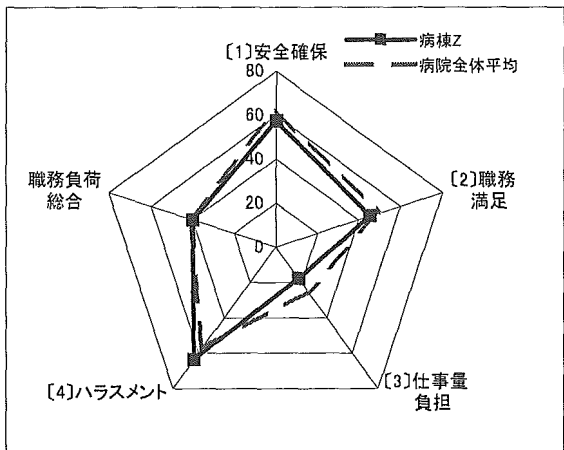
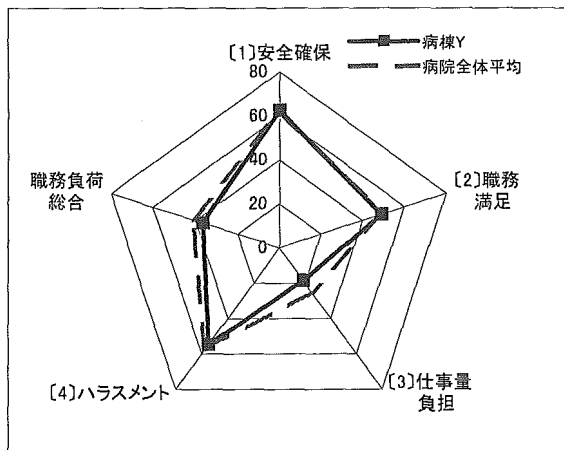

# ■ 病棟間比較

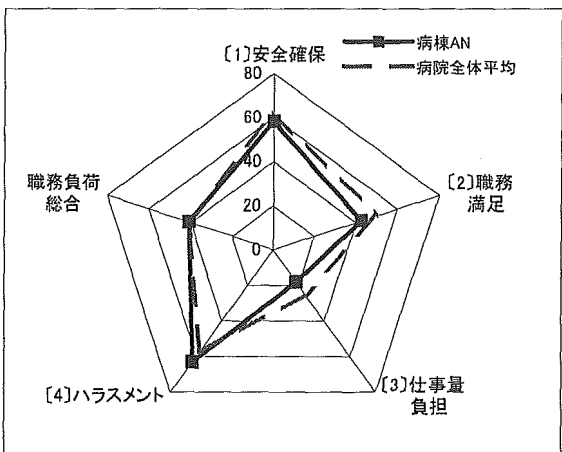
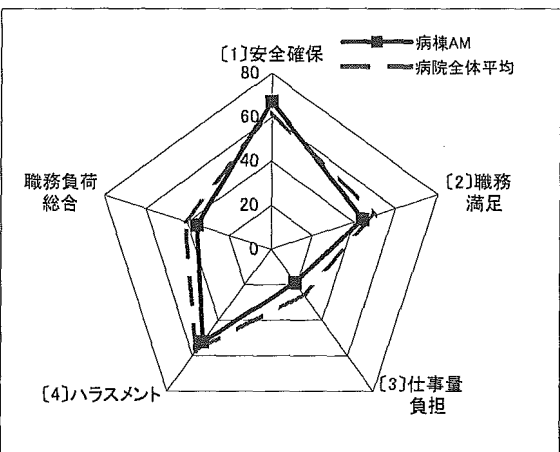
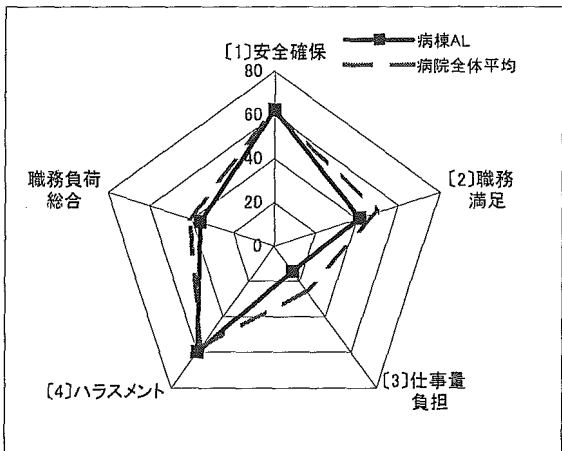
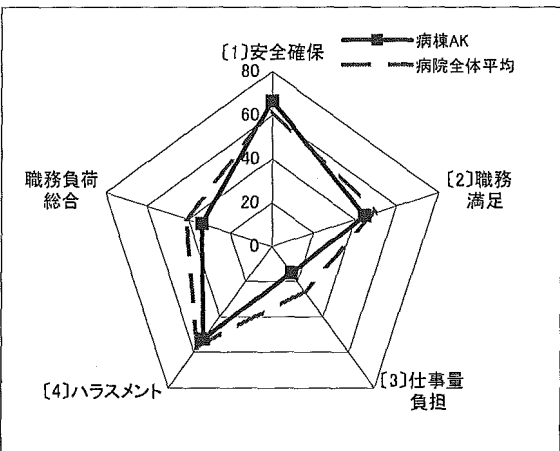
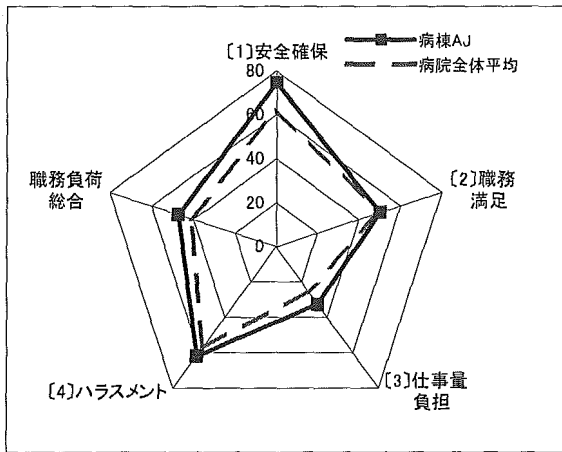
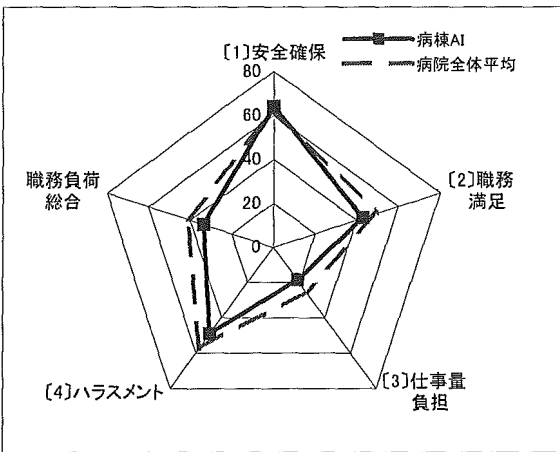
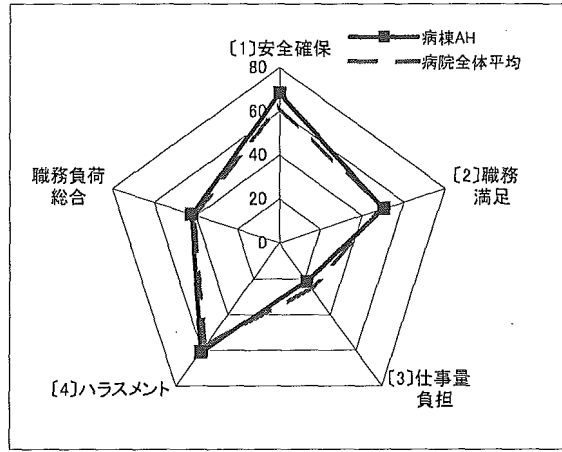
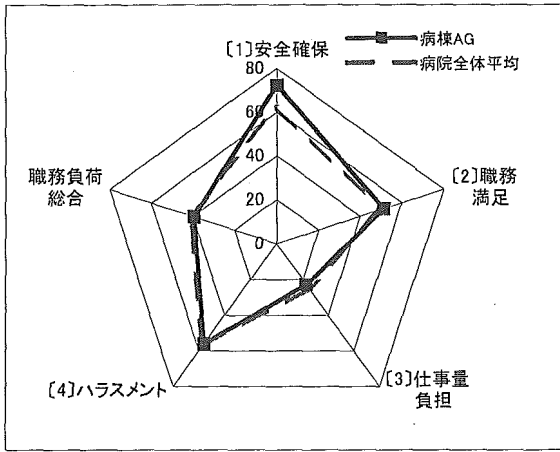

# ■ 病棟間比較

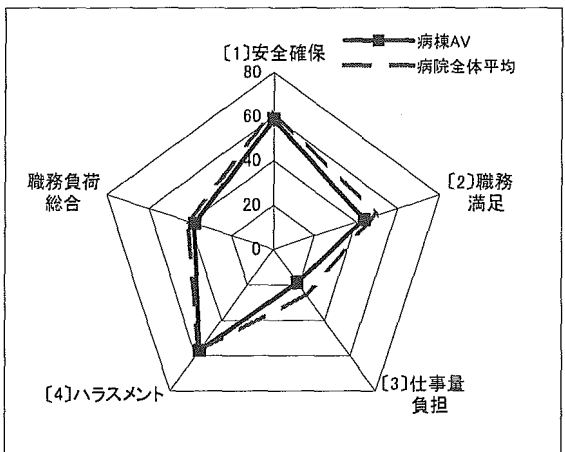
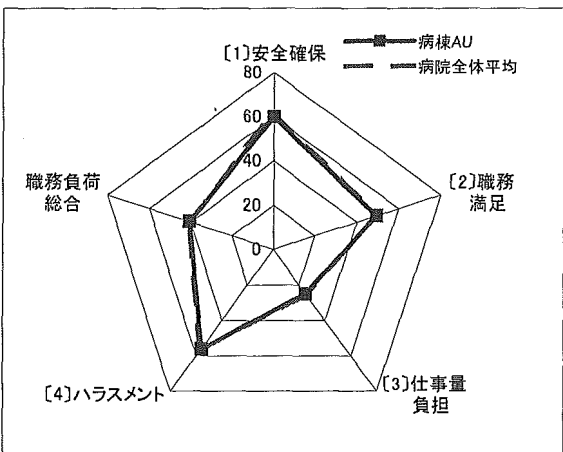
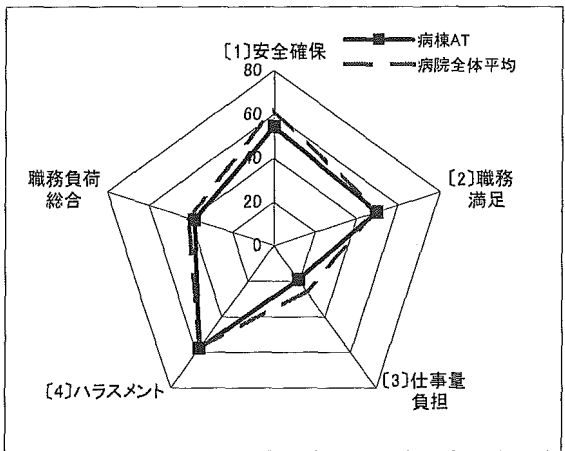
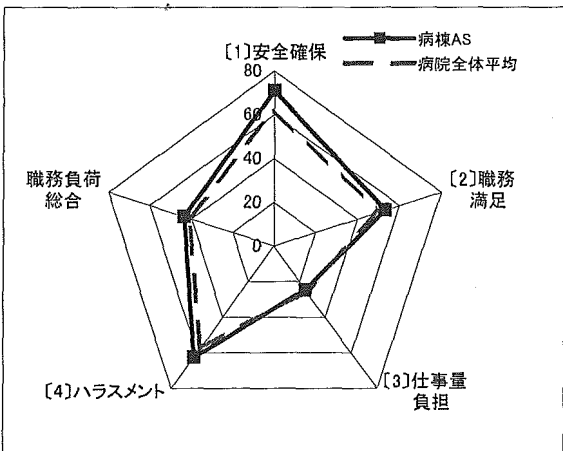
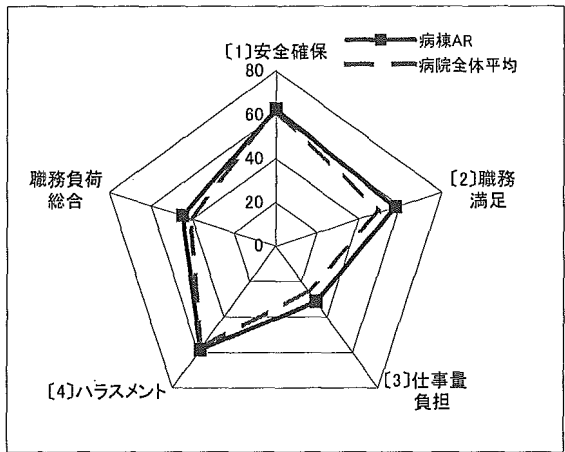
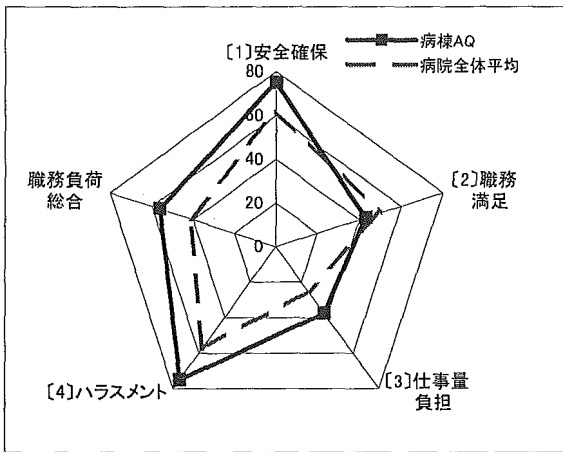
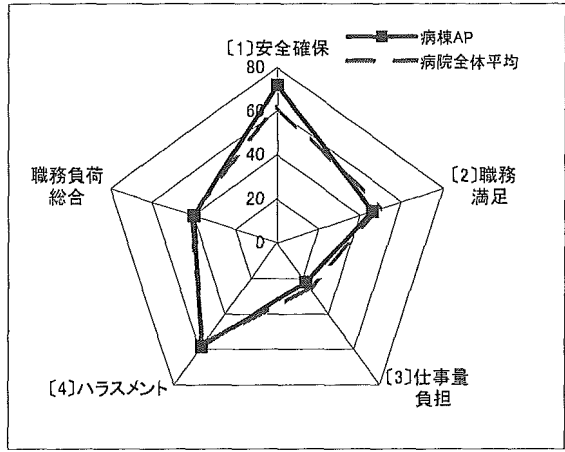
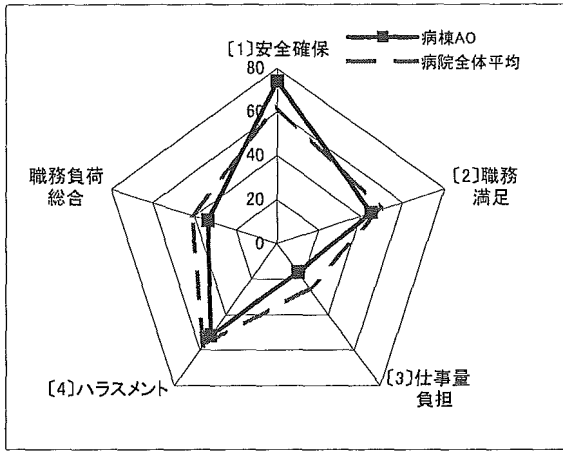

# ■ 病棟間比較

