

5. CONCLUSIONS AND OUTLOOK

Regarding the spectrum measurement, although we confirmed clean copper $K\alpha$, copper $K\beta$ and zinc $K\alpha$ lines, zinc $K\beta$ lines were hardly observed. Because weakly ionized zinc plasma (ion) transmits zinc $K\beta$ lines easily, the lines were absorbed by copper plasma. In high-photon-energy region, although we could not observe clean higher harmonics, bremsstrahlung x-rays with photon energies approximately $2E_\alpha$ and $4E_\alpha$ were left in cases where a high charging voltage of approximately 50 kV was applied.

From the experimental results, because the x-ray spectra with photon energies just beyond copper K edge are absorbed effectively by the copper plasma, zinc $K\beta$ rays are useful to produce copper fluorescent rays. In addition, we are very interested in the results using a capillary-type target for forming weakly ionized linear plasma.

In this research, we obtained sufficient characteristic x-ray intensity per pulse for CR radiography, and the generator produced number of characteristic photons was approximately 1×10^8 photons/cm² at 1.0 m per pulse. In addition, since the photon energy of characteristic x-rays can be controlled by changing target elements, various quasi-monochromatic high-speed radiographies, such as flash energy subtraction radiography using a metal filter and wide-photon-energy radiography, will be possible.

ACKNOWLEDGMENT

This work was supported by Grants-in-Aid for Scientific Research (13470154, 13877114, 16591181, and 16591222) and Advanced Medical Scientific Research from MECSST, Health and Labor Sciences Research Grants (RAMT-nano-001, RHGTEFB-genome-005 and RHGTEFB-saisei-003), Grants from the Keiryō Research Foundation, The Promotion and Mutual Aid Corporation for Private Schools of Japan, Japan Science and Technology Agency (JST), and the New Energy and Industrial Technology Development Organization (NEDO, Industrial Technology Research Grant Program in '03).

REFERENCES

1. R. Germer, "X-ray flash techniques," *J. Phys. E: Sci. Instrum.*, **12**, 336-350, 1979.
2. E. Sato, S. Kimura, S. Kawasaki, H. Isobe, K. Takahashi, Y. Tamakawa and T. Yanagisawa, "Repetitive flash x-ray generator utilizing a simple diode with a new type of energy-selective function," *Rev. Sci. Instrum.*, **61**, 2343-2348, 1990.
3. A. Shikoda, E. Sato, M. Sagae, T. Oizumi, Y. Tamakawa and T. Yanagisawa, "Repetitive flash x-ray generator having a high-durability diode driven by a two-cable-type line pulser," *Rev. Sci. Instrum.*, **65**, 850-856, 1994.
4. E. Sato, K. Takahashi, M. Sagae, S. Kimura, T. Oizumi, Y. Hayasi, Y. Tamakawa and T. Yanagisawa, "Sub-kilohertz flash x-ray generator utilizing a glass-enclosed cold-cathode triode," *Med. & Biol. Eng. & Comput.*, **32**, 289-294, 1994.
5. K. Takahashi, E. Sato, M. Sagae, T. Oizumi, Y. Tamakawa and T. Yanagisawa, "Fundamental study on a long-duration flash x-ray generator with a surface-discharge triode," *Jpn. J. Appl. Phys.*, **33**, 4146-4151, 1994.
6. E. Sato, Y. Hayasi, R. Germer, E. Tanaka, H. Mori, T. Kawai, H. Obara, T. Ichimaru, K. Takayama and H. Ido, "Irradiation of intense characteristic x-rays from weakly ionized linear molybdenum plasma," *Jpn. J. Med. Phys.*, **23**, 123-131, 2003.
7. E. Sato, Y. Hayasi, R. Germer, E. Tanaka, H. Mori, T. Kawai, T. Ichimaru, K. Takayama and H. Ido, "Quasi-monochromatic flash x-ray generator utilizing weakly ionized linear copper plasma," *Rev. Sci. Instrum.*, **74**, 5236-5240, 2003.
8. E. Sato, Y. Hayasi, R. Germer, E. Tanaka, H. Mori, T. Kawai, T. Ichimaru, S. Sato, K. Takayama and H. Ido, "Sharp characteristic x-ray irradiation from weakly ionized linear plasma," *J. Electron Spectrosc. Related Phenom.*, **137-140**, 713-720, 2004.
9. E. Sato, E. Tanaka, H. Mori, T. Kawai, S. Sato and K. Takayama, "Clean monochromatic x-ray irradiation from weakly ionized linear copper plasma," *Opt. Eng.*, **44**, 049002-1-6, 2005.
10. E. Sato, M. Sagae, E. Tanaka, Y. Hayasi, R. Germer, H. Mori, T. Kawai, T. Ichimaru, S. Sato, K. Takayama and H. Ido: Quasi-monochromatic flash x-ray generator utilizing a disk-cathode molybdenum tube, *Jpn. J. Appl. Phys.*, **43**, 7324-7328, 2004.
11. E. Sato, E. Tanaka, H. Mori, T. Kawai, T. Ichimaru, S. Sato, K. Takayama and H. Ido, "Compact monochromatic flash x-ray generator utilizing a disk-cathode molybdenum tube," *Med. Phys.*, **32**, 49-54, 2005.
12. E. Sato, R. Germer, E. Tanaka, H. Mori, T. Kawai, T. Ichimaru, S. Sato, H. Ojima, K. Takayama and H. Ido,

“Quasi-monochromatic cerium flash angiography,” *SPIE*, **5580**, 146-152, 2005.

13. E. Sato, E. Tanaka, H. Mori, T. Kawai, T. Inoue, A. Ogawa, S. Sato, K. Takayama and H. Ido, “High-speed K-edge angiography achieved with tantalum K-series characteristic x rays,” *SPIE*, **5745**, 810-817, 2005.

14. H. Obara, E. Sato, E. Tanaka, H. Mori, T. Kawai, S. Sato, H. Ojima, K. Takayama and H. Ido, “Superposition of x-ray spectra using a double-target plasma tube,” *SPIE*, **5580**, 824-831, 2005.

15. E. Sato, K. Sato and Y. Tamakawa, “Film-less computed radiography system for high-speed imaging,” *Ann. Rep. Iwate Med. Univ. Sch. Lib. Arts and Sci.*, **35**, 13-23, 2000.

*obara@rad.cms.tohoku.ac.jp; phone +81-22-717-7941; fax +81-22-717-7944

Enhanced K-edge plasma angiography achieved with tungsten $K\alpha$ rays utilizing gadolinium-based contrast media

Eiichi Sato^{*a}, Yasuomi Hayasi^a, Rudolf Germer^b, Koji Kimura^c, Etsuro Tanaka^d, Hidezo Mori^e, Toshiaki Kawai^f, Takashi Inoue^g, Akira Ogawa^g, Shigehiro Sato^h, Kazuyoshi Takayamaⁱ and Hideaki Ido^j

^aDepartment of Physics, Iwate Medical University, 3-16-1 Honchodori, Morioka 020-0015, Japan

^bITP, FHTW FB1 and TU-Berlin, Blankenhainer Str. 9, D 12249 Berlin, Germany

^cDepartment of Physiology, Tokai University School of Medicine, Boseidai, Isehara 259-1193, Japan

^dDepartment of Nutritional Science, Faculty of Applied Bio-science, Tokyo University of Agriculture, 1-1-1 Sakuragaoka, Setagaya-ku 156-8502, Japan

^eDepartment of Cardiac Physiology, National Cardiovascular Center Research Institute, 5-7-1 Fujishirodai, Suita, Osaka 565-8565 Japan

^fElectron Tube Division #2, Hamamatsu Photonics K. K., 314-5 Shimokanzo, Iwata 438-0193, Japan

^gDepartment of Neurosurgery, School of Medicine, Iwate Medical University, 19-1 Uchimaru, Morioka 020-8505, Japan

^hDepartment of Microbiology, School of Medicine, Iwate Medical University, 19-1 Uchimaru, Morioka 020-8505, Japan

ⁱShock Wave Research Center, Institute of Fluid Science, Tohoku University, 2-1-1 Katahira, Sendai 980-8577, Japan

^jDepartment of Applied Physics and Informatics, Faculty of Engineering, Tohoku Gakuin University, 1-13-1 Chuo, Tagajo 985-8537, Japan

ABSTRACT

The tungsten plasma flash x-ray generator is useful in order to perform high-speed enhanced K-edge angiography using cone beams because $K\alpha$ rays from the tungsten target are absorbed effectively by gadolinium-based contrast media. In the flash x-ray generator, a 150 nF condenser is charged up to 80 kV by a power supply, and flash x-rays are produced by the discharging. The x-ray tube is a demountable diode, and the turbomolecular pump evacuates air from the tube with a pressure of approximately 1 mPa. Since the electric circuit of the high-voltage pulse generator employs a cable transmission line, the high-voltage pulse generator produces twice the potential of the condenser charging voltage. At a charging voltage of 80 kV, the estimated maximum tube voltage and current were approximately 160 kV and 40 kA, respectively. When the charging voltage was increased, the characteristic x-ray intensities of tungsten $K\alpha$ lines increased. Using an ytterbium oxide filter, the $K\alpha$ lines were clean, and hardly any $K\beta$ lines and bremsstrahlung rays were detected. The x-ray pulse widths were approximately 60 ns, and the time-integrated x-ray intensity had a value of approximately 50 μGy at 1.0 m from the x-ray source with a charging voltage of 80 kV. Angiography was performed using a film-less computed radiography system and gadolinium-based contrast media. In angiography of non-living animals, we observed fine blood vessels of approximately 100 μm with high contrasts.

Keywords: angiography, gadolinium-based contrast media, characteristic x-rays, monochromatic x-rays, tungsten $K\alpha$ rays

1. INTRODUCTION

Ultrafast X-Ray Detectors, High-Speed Imaging, and Applications, edited by Stuart Kleinfelder, Dennis L. Paisley, Zenghu Chang, Jean-Claude Kleffer, Jerome B. Hastings, Proc. of SPIE Vol. 5920 (SPIE, Bellingham, WA, 2005) · 0277-786X/05/\$15 · doi: 10.1117/12.620212

Proc. of SPIE 592012-1

Monochromatic parallel beams from synchrotron orbital radiation have been employed in phase-contrast radiography^{1,2} and enhanced K-edge angiography.^{3,4} In particular, the parallel beams with photon energies of approximately 35 keV have been employed to perform iodine K-edge angiography, because the beams are absorbed effectively by iodine-based contrast media with a K-absorption edge of 33.2 keV. Without using a synchrotron, we have developed an x-ray generator utilizing a cerium-target tube,^{5,6} and have performed cone-beam K-edge angiography achieved with cerium K α rays of 34.6 keV.

Gadolinium-based contrast media with a K-edge of 50.2 keV have been employed to perform in MRA, and the gadolinium density has been increasing. In view of this situation, ytterbium K α rays (52.0 keV) are useful for enhanced K-edge angiography, because the K α rays are absorbed effectively by gadolinium media. As compared with angiography using iodine media, the absorbed dose can be decreased considerably utilizing angiography achieved with gadolinium media. However, because ytterbium is a lanthanide series element and has a high reactivity, K α rays of tantalum (57.1 keV) and tungsten (58.9 keV) are also useful to perform angiography.

In order to perform high-speed biomedical radiography, several different flash x-ray generators⁷⁻¹⁰ with photon energies less than 150 keV have been developed, and plasma flash x-ray generators¹¹⁻¹³ have been developed to perform a preliminary experiment for producing hard x-ray lasers. From weakly ionized plasma, clean K-series characteristic x-rays of nickel and copper and their higher harmonic hard x-rays have been produced. Furthermore, high-photon-energy monochromatic flash x-ray generators¹⁴⁻¹⁷ have been developed to produce K-series characteristic x-rays of molybdenum, cerium, ytterbium, tantalum, and tungsten, because bremsstrahlung rays are not emitted in the opposite direction to that of electron trajectory in Sommerfeld's theory.

In this article, we describe an intense monochromatic plasma flash x-ray generator with a tungsten target tube, and used it to perform a preliminary study on angiography achieved with tungsten K α rays using an ytterbium oxide filter.

2. PRINCIPLE OF K-EDGE ANGIOGRAPHY

Figure 1 shows the mass attenuation coefficients of gadolinium at the selected energies; the coefficient curve is discontinuous at the gadolinium K-edge. The average photon energy of the tungsten K α lines is shown just above the gadolinium K-edge. The average photon energy of tungsten K α lines is 58.9 keV, and gadolinium contrast media with a K-absorption edge of 50.2 keV absorb the lines easily. Therefore, blood vessels were observed with high contrasts.

3. GENERATOR

3.1 High-voltage circuit

Figure 2 shows a block diagram of a high-intensity plasma flash x-ray generator. The generator consists of the following essential components: a high-voltage power supply, a high-voltage condenser with a capacity of approximately 150 nF, an air gap switch, a turbomolecular pump, a thyatron pulse generator as a trigger device, and a flash x-ray tube. In this generator, a coaxial cable transmission line is employed in order to increase maximum tube voltage using high-voltage reflection. The high-voltage main condenser is charged up to 80 kV by the power supply, and electric charges in the condenser are discharged to the tube through the four cables after closing the gap switch with the trigger device.

3.2 X-ray tube

The x-ray tube is a demountable cold-cathode diode that is connected to the turbomolecular pump with a pressure of approximately 1 mPa (Fig. 3). This tube consists of the following major parts: a ring-shaped graphite cathode with an inside diameter of 4.5 mm, a stainless-steel vacuum chamber, a nylon insulator, a polyethylene terephthalate (Mylar) x-ray window 0.25 mm in thickness, and a rod-shaped tungsten target 3.0 mm in diameter. The distance between the target and cathode electrodes can be regulated from the outside of the tube, and is set to 1.5 mm. As electron beams from the cathode electrode are roughly converged to the target by the electric field in the tube, evaporation leads to the formation of weakly ionized plasma, consisting of tungsten ions and electrons, around the target. Because bremsstrahlung rays are not emitted in the opposite direction to that of electron acceleration (Fig. 4), tungsten K α rays can be produced using an ytterbium oxide filter with a surface density of 20 mg/cm².

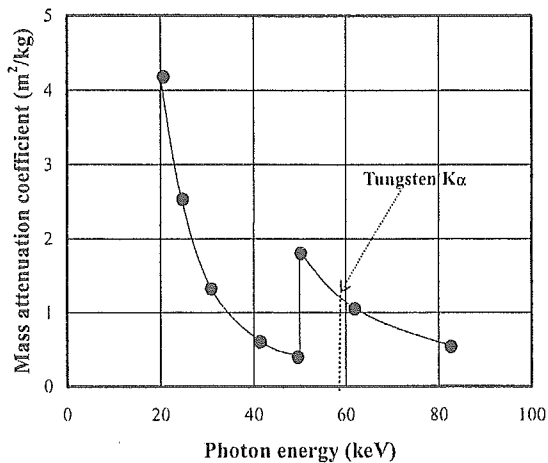

Figure 1: Mass attenuation coefficient of gadolinium and the average photon energy of tungsten $K\alpha$ lines is shown above gadolinium K edge.

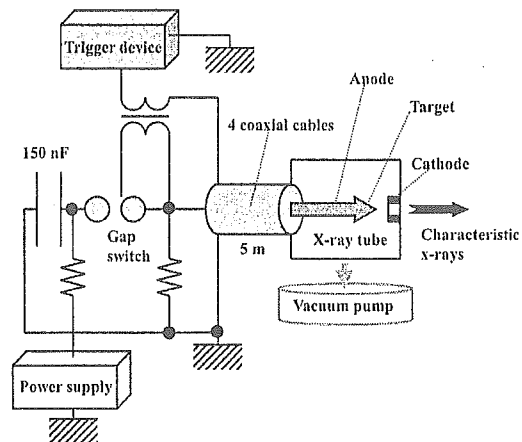

Figure 2: Block diagram including high-voltage circuit of the intense monochromatic plasma flash x-ray generator with a tungsten-target tube.

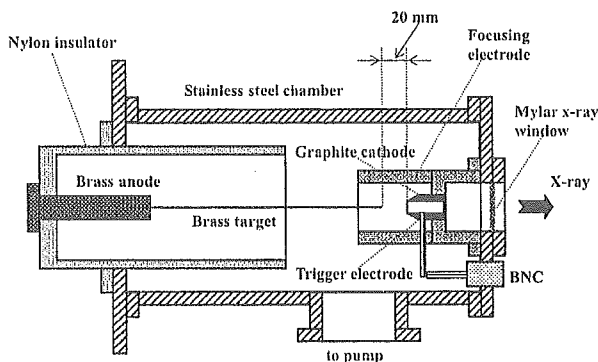

Figure 3: Schematic drawing of the flash x-ray tube with a rod-shaped tungsten target.

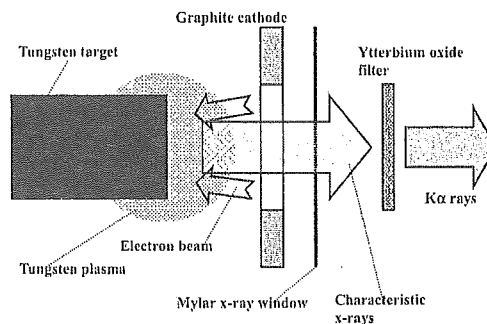

Figure 4: Irradiation of K-series characteristic x-rays of tungsten.

4. CHARACTERISTICS

4.1 Tube voltage and current

In this generator, it was difficult to measure the tube voltage and current since the tube voltages were high, and there was no space to set a current transformer for measuring the tube current. Currently, the voltage and current roughly display damped oscillations. When the charging voltage was increased, both the maximum tube voltage and current increased. At a charging voltage of 80 kV, the estimated maximum values of the tube voltage and current were approximately 160 kV (2 times the charging voltage) and 40 kA, respectively.

4.2 X-ray output

X-ray output pulse was detected using a combination of a plastic scintillator and a photomultiplier (Fig. 5). The x-ray pulse height substantially increased with corresponding increases in the charging voltage. The x-ray pulse widths were approximately 60 ns, and the time-integrated x-ray intensity measured by a thermoluminescence dosimeter (Kyokko TLD Reader 1500 having MSO-S elements without energy compensation) had a value of approximately 50 μGy at 1.0

m from the x-ray source with a charging voltage of 80 kV.

4.3 X-ray source

In order to observe the $K\alpha$ x-ray source, we employed a 100- μm -diameter pinhole camera and an x-ray film (Polaroid XR-7) (Fig. 6). When the charging voltage was increased, the plasma x-ray source grew, and both spot dimension and intensity increased. Because the x-ray intensity is the highest at the center of the spot, both the dimension and intensity decreased according to both increases in the thickness of a filter for absorbing x-rays and decreases in the pinhole diameter.

4.4 X-ray spectra

X-ray spectra were measured using a transmission-type spectrometer with a lithium fluoride curved crystal 0.5 mm in thickness. The x-ray intensities of the spectra were detected by an imaging plate of a computed radiography (CR) system¹⁸ (Konica Minolta Regius 150) with a wide dynamic range, and relative x-ray intensity was calculated from Dicom original digital data corresponding to x-ray intensity; the data was scanned by Dicom viewer in the film-less CR system. Subsequently, the relative x-ray intensity as a function of the data was calibrated using a conventional x-ray generator, and we confirmed that the intensity was proportional to the exposure time. Figure 7 shows measured spectra from the tungsten target. We observed clean $K\alpha$ lines, while $K\beta$ lines and bremsstrahlung rays were hardly detected. The $K\alpha$ intensity increased with increases in the charging voltage.

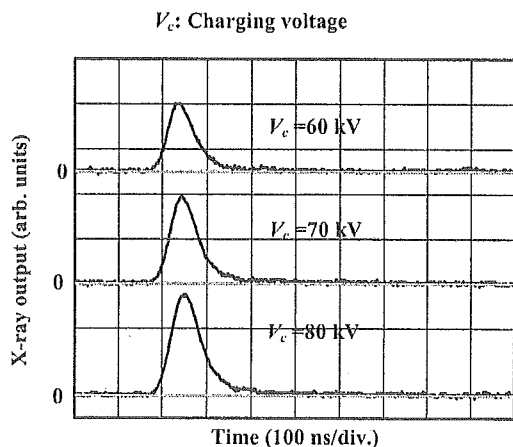

Figure 5: X-ray outputs detected using a combination of a plastic scintillator and a photomultiplier.

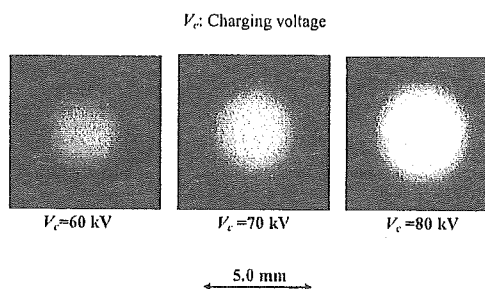

Figure 6: Images of $K\alpha$ -ray source obtained using a pinhole camera with changes in the charging voltage.

5. ANGIOGRAPHY

The flash angiography was performed using the CR system and the filter at 1.2 m from the x-ray source, and the charging voltage was 80 kV.

Firstly, rough measurements of spatial resolution were made using wires. Figure 8 shows radiograms of tungsten wires in a rod made of polymethyl methacrylate (PMMA). Although the image contrast decreased somewhat with decreases in the wire diameter, due to blurring of the image caused by the sampling pitch of 87.5 μm , a 50 μm -diameter wire could be observed.

The image of water (20% gadolinium oxide suspension) falling into a polypropylene beaker from a plastic test tube is shown in Fig. 9. The diameter of gadolinium oxide powder ranges from 1 to 10 μm . Because the x-ray duration was about 60 ns, the stop-motion image of water could be obtained.

Figure 10 shows an angiogram of a polytetrafluoroethylene (Teflon) tube in a PMMA case using a contrast medium which contains approximately 65% gadodiamidehydrate, and a high-contrast tube with a bore diameter of 1.0 mm is

observed. Figures 11 and 12 show angiograms of a rabbit ear and head using gadolinium oxide powder, and fine blood vessels of approximately 100 μm were visible.

6. CONCLUSIONS AND OUTLOOK

We succeeded in producing tungsten $K\alpha$ rays and in performing K-edge angiography using gadolinium contrast media with a K-edge of 50.2 keV, and this K-edge angiography could be a useful technique to decrease the dose absorbed by patients. In angiography, we employed tungsten $K\alpha$ (58.9 keV) rays by absorbing $K\beta$ rays (approximately 67 keV) using the ytterbium oxide filter, and L-series characteristic rays were also absorbed.

We obtained sufficient x-ray intensity per pulse for CR angiography with x-ray durations of approximately 60 ns, and the intensity can be increased by increasing the charging voltage at a constant target-cathode space. Currently, the x-ray duration increased with increases in the target-cathode space. In this research, the generator produced instantaneous number of $K\alpha$ photons was approximately 1.5×10^8 photons/cm² per pulse at 1.0 m from the source.

Because the dimensions of the x-ray source are primarily determined by the target diameter, the diameter should be minimized in order to improve the spatial resolution, and can be reduced to approximately 0.5 mm. Because the x-ray intensity is the highest at the center of the spot, the effective focal spot size decreased during x-ray absorption in an object. Subsequently, the sampling pitch can be decreased to 43.8 μm using a CR system (Konica Minolta Regius 190) to observe fine blood vessels of approximately 50 μm in diameter.

Using this flash x-ray generator, enhanced K-edge angiography using iodine contrast media and a cerium target can be also performed. In addition, steady-state monochromatic x-rays can be produced by a similar tube utilizing a hot cathode and a constant high-voltage power supply. Using a tungsten or a molybdenum target, fine focusing can be realized, and these x-ray generators could be employed to perform quasi-monochromatic phase-contrast radiography for edge enhancement.

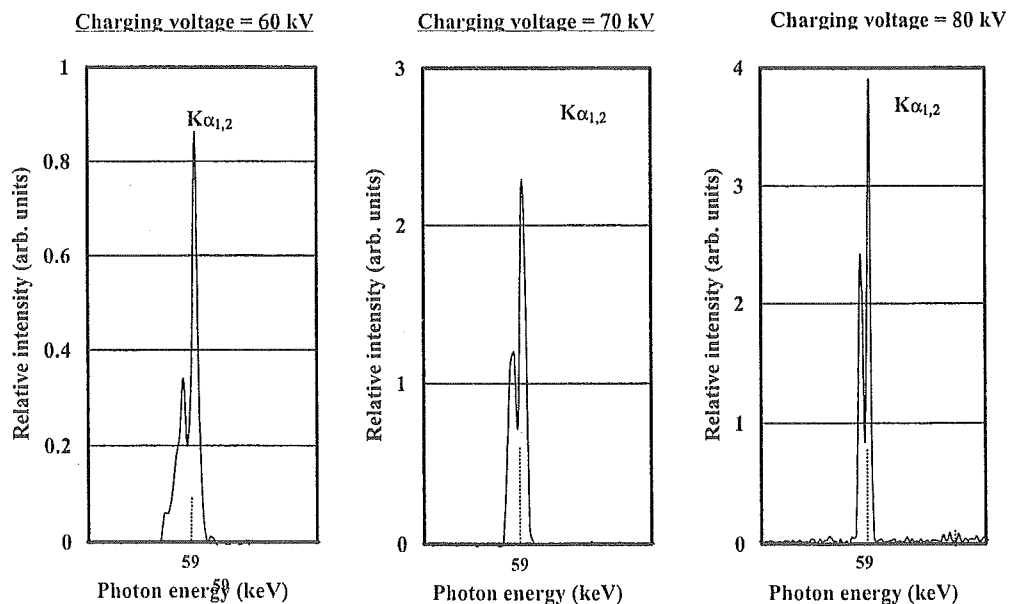

Figure 7: X-ray spectra from a tungsten target. The spectra were measured using a transmission type spectrometer with a lithium fluoride curved crystal.

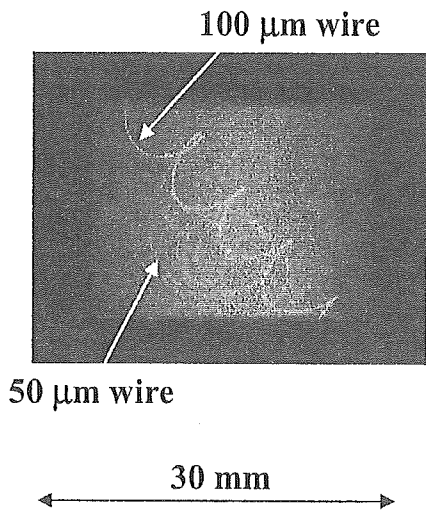

Figure 8: Radiograms of tungsten wires in a PMMA rod. gadodiamidehydrate.

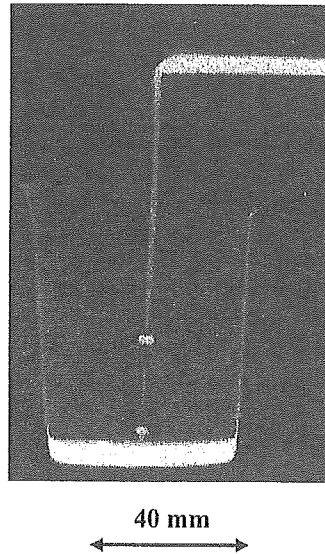

Figure 9: Radiogram of water falling into a polypropylene beaker from a glass test tube.

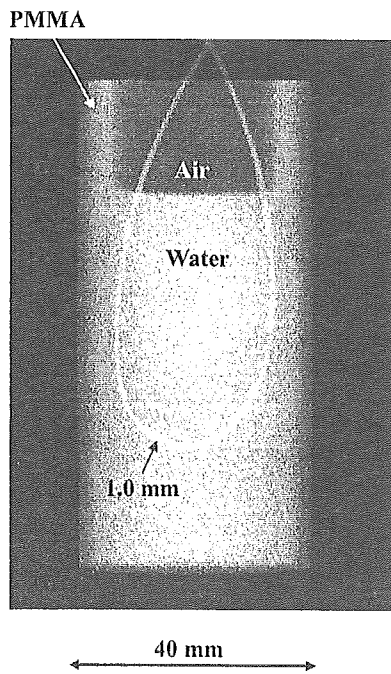

Figure 10: Angiography of a Teflon tube using a contrast medium which contains approximately 65% gadodiamidehydrate.

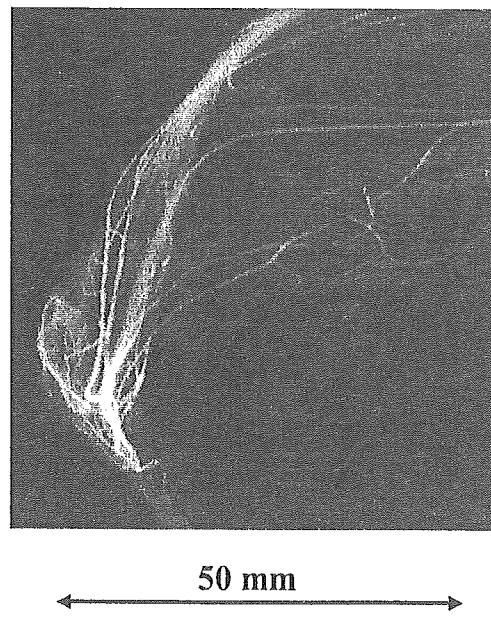

Figure 11: Angiography of a rabbit ear using gadolinium oxide powder.

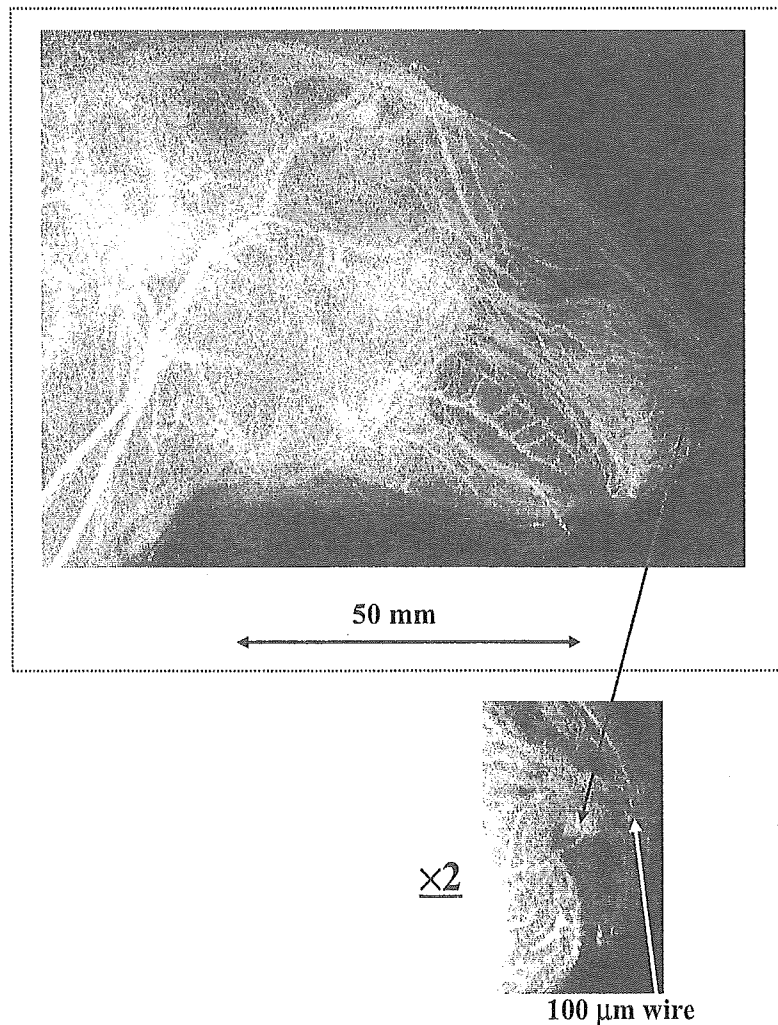

Figure 12: Angiography of a rabbit head using gadolinium oxide powder.

ACKNOWLEDGEMENTS

This work was supported by Grants-in-Aid for Scientific Research (13470154, 13877114, 16591181, and 16591222) and Advanced Medical Scientific Research from MECSS, Health and Labor Sciences Research Grants (RAMT-nano-001, RHGTEFB-genome-005 and RHGTEFB-saisei-003), Grants from the Keiryō Research Foundation, The Promotion and Mutual Aid Corporation for Private Schools of Japan, Japan Science and Technology Agency (JST), and the New Energy and Industrial Technology Development Organization (NEDO, Industrial Technology Research Grant Program in '03).

REFERENCES

1. A. Momose, T. Takeda, Y. Itai and K. Hirano, "Phase-contrast x-ray computed tomography for observing biological soft tissues," *Nature Medicine*, **2**, 473-475, 1996.

2. M. Ando, A. Maksimenko, H. Sugiyama, W. Pattanasiriwisawa, K. Hyodo and C. Uyama, "A simple x-ray dark- and bright- field imaging using achromatic Laue optics," *Jpn. J. Appl. Phys.*, **41**, L1016-L1018, 2002.
3. H. Mori, K. Hyodo, E. Tanaka, M. U. Mohammed, A. Yamakawa, Y. Shinozaki, H. Nakazawa, Y. Tanaka, T. Sekka, Y. Iwata, S. Honda, K. Umetani, H. Ueki, T. Yokoyama, K. Tanioka, M. Kubota, H. Hosaka, N. Ishizawa and M. Ando, "Small-vessel radiography in situ with monochromatic synchrotron radiation," *Radiology*, **201**, 173-177, 1996.
4. K. Hyodo, M. Ando, Y. Oku, S. Yamamoto, T. Takeda, Y. Itai, S. Ohtsuka, Y. Sugishita and J. Tada, "Development of a two-dimensional imaging system for clinical applications of intravenous coronary angiography using intense synchrotron radiation produced by a multipole wiggler," *J. Synchrotron Rad.*, **5**, 1123-1126, 1998.
5. E. Sato, Y. Hayasi, R. Germer, E. Tanaka, H. Mori, T. Kawai, T. Ichimaru, S. Sato, K. Takayama and H. Ido, "Portable x-ray generator utilizing a cerium-target radiation tube for angiography," *J. Electron Spectrosc. Related Phenom.*, **137-140**, 699-704, 2004.
6. E. Sato, E. Tanaka, H. Mori, T. Kawai, T. Ichimaru, S. Sato, K. Takayama and H. Ido, "Demonstration of enhanced K-edge angiography using a cerium target x-ray generator," *Med. Phys.*, **31**, 3017-3021, 2004.
7. R. Germer, "X-ray flash techniques," *J. Phys. E: Sci. Instrum.*, **12**, 336-350, 1979.
8. E. Sato, S. Kimura, S. Kawasaki, H. Isobe, K. Takahashi, Y. Tamakawa and T. Yanagisawa, "Repetitive flash x-ray generator utilizing a simple diode with a new type of energy-selective function," *Rev. Sci. Instrum.*, **61**, 2343-2348, 1990.
9. A. Shikoda, E. Sato, M. Sagae, T. Oizumi, Y. Tamakawa and T. Yanagisawa, "Repetitive flash x-ray generator having a high-durability diode driven by a two-cable-type line pulser," *Rev. Sci. Instrum.*, **65**, 850-856, 1994.
10. E. Sato, K. Takahashi, M. Sagae, S. Kimura, T. Oizumi, Y. Hayasi, Y. Tamakawa and T. Yanagisawa, "Sub-kilohertz flash x-ray generator utilizing a glass-enclosed cold-cathode triode," *Med. & Biol. Eng. & Comput.*, **32**, 289-294, 1994.
11. E. Sato, Y. Hayasi, R. Germer, E. Tanaka, H. Mori, T. Kawai, T. Ichimaru, K. Takayama and H. Ido, "Quasi-monochromatic flash x-ray generator utilizing weakly ionized linear copper plasma," *Rev. Sci. Instrum.*, **74**, 5236-5240, 2003.
12. E. Sato, Y. Hayasi, R. Germer, E. Tanaka, H. Mori, T. Kawai, T. Ichimaru, S. Sato, K. Takayama and H. Ido, "Sharp characteristic x-ray irradiation from weakly ionized linear plasma," *J. Electron Spectrosc. Related Phenom.*, **137-140**, 713-720, 2004.
13. E. Sato, E. Tanaka, H. Mori, T. Kawai, S. Sato and K. Takayama, "Clean monochromatic x-ray irradiation from weakly ionized linear copper plasma," *Opt. Eng.*, **44**, 049002-1-6, 2005.
14. E. Sato, M. Sagae, E. Tanaka, Y. Hayasi, R. Germer, H. Mori, T. Kawai, T. Ichimaru, S. Sato, K. Takayama and H. Ido: Quasi-monochromatic flash x-ray generator utilizing a disk-cathode molybdenum tube, *Jpn. J. Appl. Phys.*, **43**, 7324-7328, 2004.
15. E. Sato, E. Tanaka, H. Mori, T. Kawai, T. Ichimaru, S. Sato, K. Takayama and H. Ido, "Compact monochromatic flash x-ray generator utilizing a disk-cathode molybdenum tube," *Med. Phys.*, **32**, 49-54, 2005.
16. E. Sato, R. Germer, E. Tanaka, H. Mori, T. Kawai, T. Ichimaru, S. Sato, H. Ojima, K. Takayama and H. Ido, "Quasi-monochromatic cerium flash angiography," *SPIE*, **5580**, 146-152, 2005.
17. E. Sato, E. Tanaka, H. Mori, T. Kawai, T. Inoue, A. Ogawa, S. Sato, K. Takayama and H. Ido, "High-speed K-edge angiography achieved with tantalum K-series characteristic x rays," *SPIE*, **5745**, 810-817, 2005.
18. E. Sato, K. Sato, T. Usuki and Y. Tamakawa, "Film-less computed radiography system for high-speed imaging," *Ann. Rep. Iwate Med. Univ. Sch. Lib. Arts and Sci.*, **35**, 13-23, 2000.

*dresato@iwate-med.ac.jp; phone +81-19-651-5111; fax +81-19-654-9282

Monochromatic flash x-ray generator utilizing a disk-cathode silver tube

Eiichi Sato, MEMBER SPIE
Yasuomi Hayasi
Iwate Medical University
Department of Physics
Morioka 020-0015, Japan
E-mail: dresato@iwate-med.ac.jp

Rudolf Germer
ITP
FHTW FB1 and TU-Berlin
D 12249 Berlin, Germany

Etsuro Tanaka
Tokyo University of Agriculture
Department of Nutritional Science
Faculty of Applied Bioscience
Setagaya-ku 156-8502, Japan

Hidezo Mori
National Cardiovascular Center Research Institute
Department of Cardiac Physiology
Osaka 565-8565, Japan

Toshiaki Kawai, MEMBER SPIE
Hamamatsu Photonics K. K.
Electron Tube Division 2
Iwata 438-0193, Japan

Takashi Inoue
Akira Ogawa
Iwate Medical University
Department of Neurosurgery
School of Medicine
Morioka 020-8505, Japan

Sigehiro Sato
Iwate Medical University
Department of Microbiology
School of Medicine
Morioka 020-8505, Japan

Toshio Ichimaru
Hirosaki University
Department of Radiological Technology
School of Health Sciences
Hirosaki 036-8564, Japan

Kazuyoshi Takayama, MEMBER SPIE
Tohoku University
Shock Wave Research Center
Institute of Fluid Science
Sendai 980-8577, Japan

Jun Onagawa
Hideaki Ido
Tohoku Gakuin University
Department of Applied Physics and Informatics
Faculty of Engineering
1-13-1 Chuo, Tagajo 985-8537
Japan

Abstract. The high-voltage condensers in a polarity-inversion two-stage Marx surge generator are charged from -50 to -70 kV by a power supply, and the electric charges in the condensers are discharged to an x-ray tube after closing gap switches in the surge generator with a trigger device. The x-ray tube is a demountable diode, and the turbomolecular pump evacuates air from the tube with a pressure of approximately 1 mPa. Clean silver $K\alpha$ lines are produced using a $30\text{-}\mu\text{m}$ -thick palladium filter, since the tube utilizes a disk cathode and a rod target, and bremsstrahlung rays are not emitted in the opposite direction to that of electron acceleration. At a charging voltage of -70 kV, the instantaneous tube voltage and current are 90 kV and 0.8 kA, respectively. The x-ray pulse widths are approximately 80 ns, and the instantaneous number of generator-produced $K\alpha$ photons is approximately 4×10^7 photons/cm² per pulse at 0.3 m from the source 3.0 mm in diameter. © 2005 Society of Photo-Optical Instrumentation Engineers. [DOI: 10.1117/1.2049248]

Subject terms: x-ray source; x-ray tube; x-ray spectra; rapid imaging; x-ray beam filtration; monochromatic x-rays.

Paper 040731R received Oct. 6, 2004; revised manuscript received Mar. 8, 2005; accepted for publication Mar. 11, 2005; published online Sep. 16, 2005. This paper is a revision of a paper presented at the SPIE conference on X-Ray Sources and Optics, August 2004, Denver, CO. The paper presented there appears (unrefereed) in SPIE Proceedings Vol. 5537.

1 Introduction

Energy-selective monochromatic radiography is a useful method for medical radiography, and quasimonochromatic x-rays have been produced using a K-edge filter when conventional medical x-ray tubes are employed. In contrast, monochromatic parallel x-ray beams have been produced using synchrotrons in conjunction with silicon single crystals, and have been applied effectively to enhanced K-edge angiography,¹⁻³ achieved with x-rays with a photon energy of approximately 35 keV.

In high-speed radiography, we have developed several different flash x-ray generators⁴⁻⁹ utilizing cold cathode x-ray tubes, and intense and clean K-series characteristic x-rays have been produced from the axial direction of weakly ionized linear plasma¹⁰⁻¹⁴ of nickel and copper using a plasma flash x-ray generator. In the plasma, bremsstrahlung spectra with photon energies of higher than the K-absorption edge are effectively absorbed and are converted into fluorescent x-rays. The plasma then transmits the fluorescent rays easily. Subsequently, the photon ener-

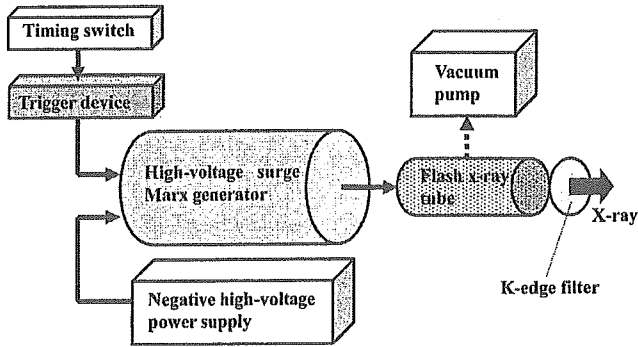

Fig. 1 Block diagram of the compact quasimonochromatic flash x-ray generator.

gies of the characteristic x-rays are determined by the target element, and the tube voltage should be increased in cases where the high-photon-energy characteristic x-rays are selected. However, it is difficult to increase the photon energies, since the maximum tube voltage is approximately 60 kV without using a high-voltage gap switch.

To increase the maximum tube voltage, a multistage surge Marx generator^{15,16} is useful, because the output voltage is equal to the value of the condenser charging voltage multiplied by the stage number. In addition, characteristic x-rays can be produced by considering the angle dependence of bremsstrahlung x-rays when a cold cathode diode, in conjunction with the surge generator, is employed.

In this study, we developed a compact flash x-ray generator utilizing a silver-target radiation tube, and used it to perform a preliminary experiment for producing clean monochromatic x-rays.

2 Experimental Setup

2.1 High-Voltage Circuit

Figure 1 shows a block diagram of a compact monochromatic flash x-ray generator. This generator consists of the following components: a constant high-voltage power supply, a surge Marx generator with a capacity during main discharge of 425 pF, a thyatron trigger device for the surge generator, a turbomolecular pump, and a flash x-ray tube. Since the electric circuit of the high-voltage pulse generator

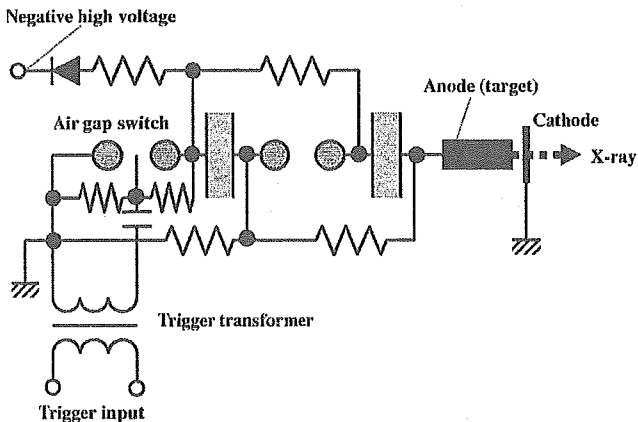

Fig. 2 Circuit diagram of the flash x-ray generator.

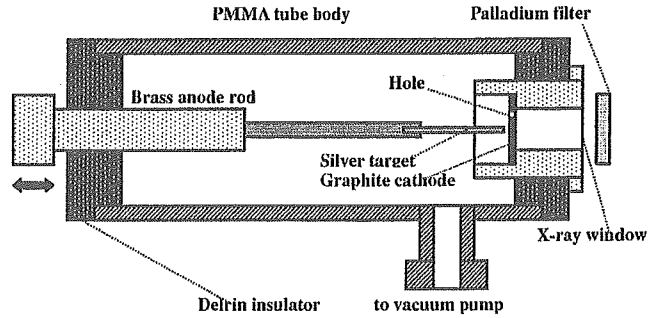

Fig. 3 Schematic drawing of the flash x-ray tube.

employs a polarity-inversion two-stage Marx line^{13,14} (Fig. 2), the surge generator produces twice the potential of the condenser charging voltage. When two condensers inside of the surge generator are charged from -50 to -70 kV, the ideal output voltage ranges from 100 to 140 kV.

2.2 X-ray Tube

The x-ray tube is a demountable diode type, as illustrated in Fig. 3. This tube is connected to the turbomolecular pump with a pressure of approximately 1 mPa and consists of the following major devices: a rod-shaped silver target 3.0 mm in diameter, a disk cathode made of graphite, a polyethylene terephthalate (Mylar) x-ray window 0.25 mm in thickness, and a polymethyl methacrylate (PMMA) tube body. The target-cathode space was regulated to 1.0 mm from the outside of the x-ray tube by rotating the anode rod, and the transmission x-rays are obtained through a 1.0-mm-thick graphite cathode and an x-ray window. In Sommerfeld's theory,¹⁷ because bremsstrahlung rays are not emitted in the opposite direction to that of electron trajectory (Fig. 4), silver $K\alpha$ rays can be produced using a 30- μ m-thick palladium K-edge filter. In the K-series characteristic x-ray irradiation, $K\alpha$ rays are left by absorbing $K\beta$ rays to perform the preliminary experiment for producing clean monochromatic x-rays and to confirm the filtering effect.

3 Results and Discussion

3.1 Tube Voltage and Current

Tube voltage and current were measured using a high-voltage divider with an input impedance of 10 k Ω and a

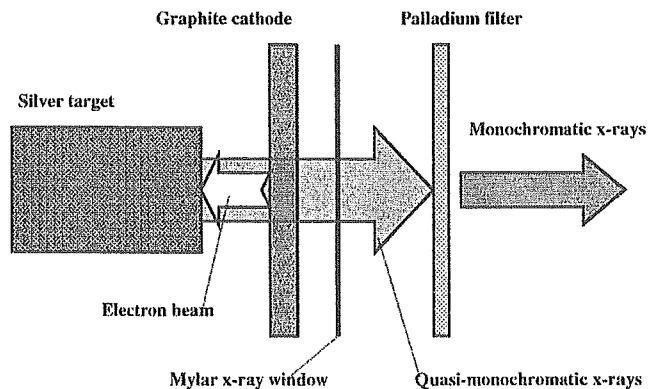

Fig. 4 Irradiation of silver $K\alpha$ rays using a palladium K-edge filter.

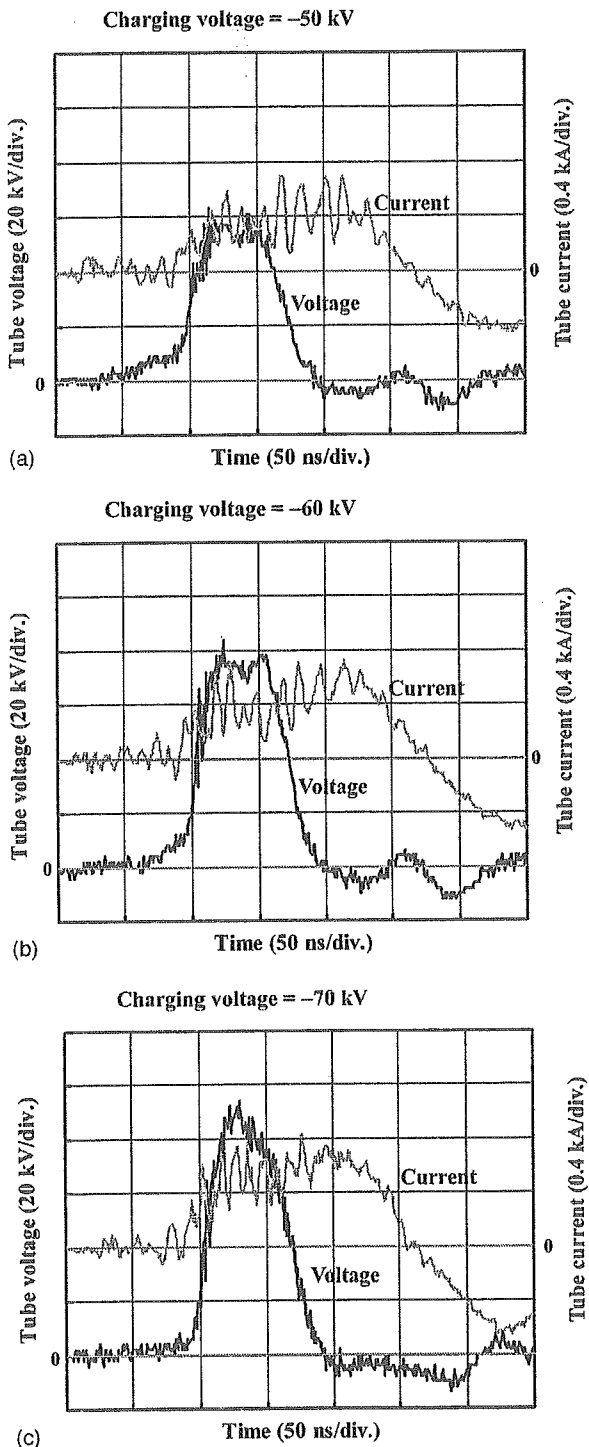

Fig. 5 Variations in tube voltage and current with charging voltages of (a) -50 kV, (b) -60 kV, and (c) -70 kV.

current transformer, respectively (Fig. 5). The voltage and current displayed roughly damped oscillations, because the discharge resistance in the tube varied rapidly from infinity to approximately 0 Ω during the discharge. Thus, at the first quarter cycle of the oscillations, when the voltage decreased, the current increased. Within twice the potential of the condenser charging voltage, the instantaneous voltage increases according to increases in the charging voltage and

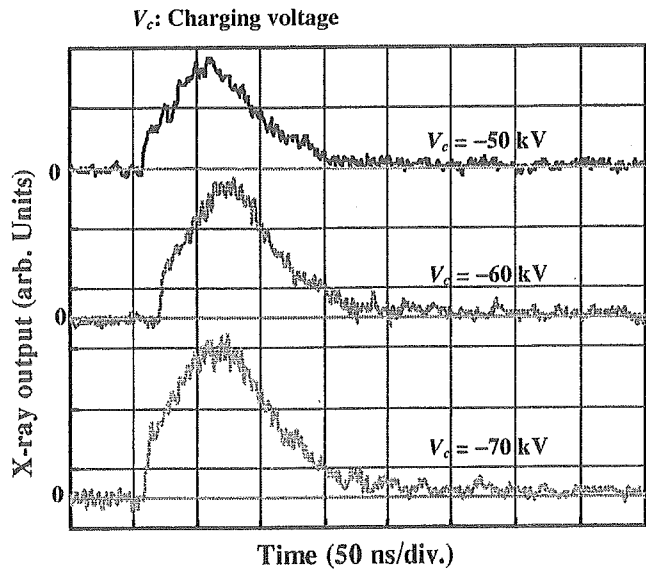

Fig. 6 X-ray outputs at the indicated conditions using the filter.

to increases in the target-cathode space. On the other hand, the instantaneous current increases with increases in the charging voltage and decreases in the space. At a space of 1.0 mm, the instantaneous voltage and current increased with increases in the charging voltage, and the voltage and current were approximately 90 kV and 0.8 kA, respectively, at a charging voltage of -70 kV.

3.2 X-ray Output

An x-ray output pulse was detected using a combination of a plastic scintillator, a photomultiplier, and the filter (Fig. 6). When the charging voltage was increased, the pulse height increased, but the width seldom varied. The widths were approximately 80 ns, and the time-integrated x-ray dose measured using a thermoluminescence dosimeter (Kyokko TLD Reader 1500 having MSO-S elements without energy compensation) had a value of approximately 90 μGy per pulse at 0.3 m from the x-ray source with a charging voltage of -70 kV. In the dose measurement, five elements (detectors) with a diameter of 2.0 mm and a length of 11 mm were set at 0.3 m from the x-ray source, and the dose was the average value of ten shots of flash

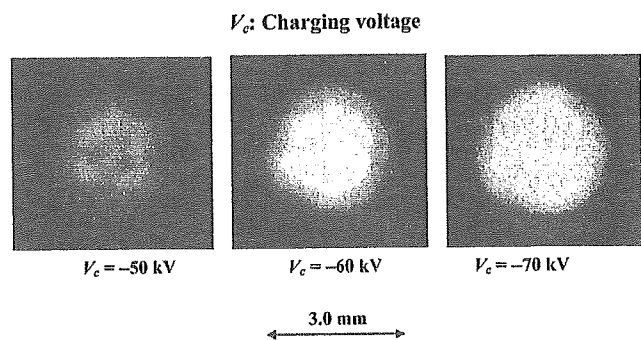

Fig. 7 Images of x-ray sources of Kα lines with changes in the charging voltage.

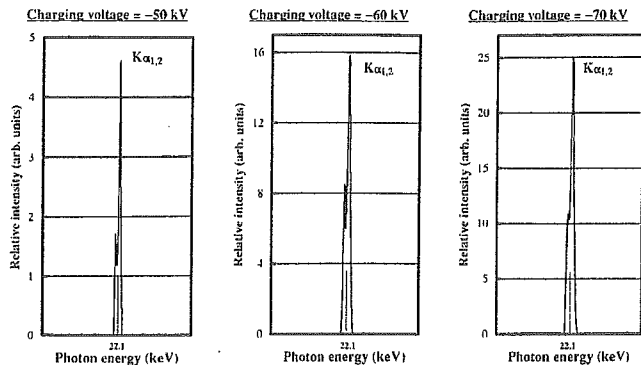

Fig. 8 X-ray spectra from a silver target with the filter.

x-rays and five elements. Using this high-voltage pulse generator, the maximum repetition rate of flash x-rays was approximately 50 Hz. At a charging voltage of -70 kV and the maximum rate, the electric power of the flash x-ray generator and the dose rate are estimated at approximately 200 W and 400 μGy/s at 1.0 m, respectively.

3.3 X-ray Source

To observe the x-ray source, we employed a 100-μm-diam pinhole camera, an x-ray film (Polaroid XR-7), and the filter (Fig. 7). When the charging voltage was increased, the spot intensity increased, and the intensities corresponded well to the x-ray pulse height. The dimension was almost equal to the target diameter and had a value of approximately 3.0 mm.

3.4 X-ray Spectra

X-ray spectra were measured by a transmission-type spectrometer with a lithium fluoride curved crystal 0.5 mm thick. The spectra were taken using a computed radiography (CR) system¹⁸ (Konica Regius 150) with a wide dynamic range, and relative x-ray intensity was calculated from Dicom digital data. Figure 8 shows the measured spectra from the silver target with the filter. We observed clean Kα lines, while bremsstrahlung rays were hardly de-

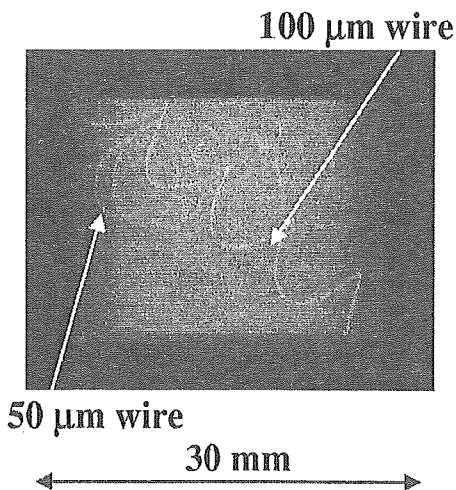

Fig. 9 Radiograms of tungsten wires of 50 and 100 μm in a rod made of polymethyl methacrylate.

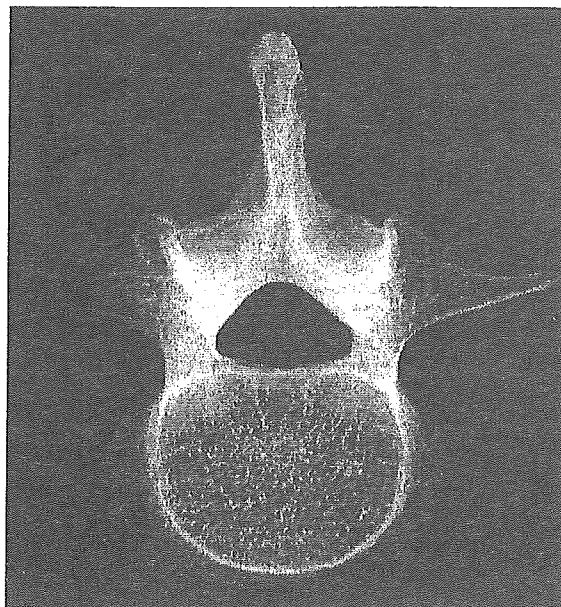

Fig. 10 Radiogram of a vertebra.

tected. When the charging voltage was increased, the instantaneous tube voltage and current increased, and the Kα intensity substantially increased.

3.5 Radiography

Monochromatic flash radiography was performed using the CR system 0.3 m from the x-ray source with the filter, and the charging voltage was -70 kV. First, rough measure-

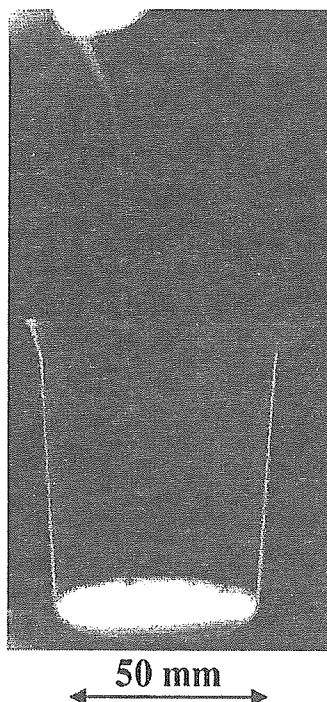

Fig. 11 Radiogram of water falling into a polypropylene beaker from a glass test tube.

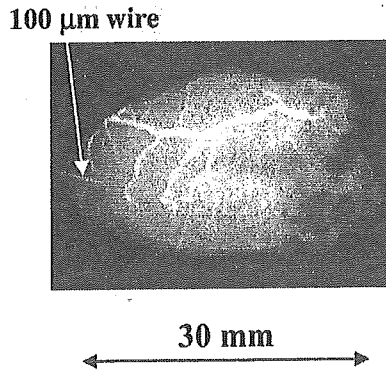

Fig. 12 Angiogram of a rabbit heart.

ments of spatial resolution were made using wires. Figure 9 shows radiograms of tungsten wires in a rod made of polymethyl methacrylate. Although the image contrast increased with increases in the wire diameter, a 50- μm -diam wire could be observed.

Figure 10 shows a radiogram of a vertebra, and fine structures in the vertebra are observed. Next, the image of water falling into a polypropylene beaker from an injector is shown in Fig. 11. This image was taken with the slight addition of an iodine-based contrast medium. Because the x-ray duration was approximately 80 ns, the stop-motion image of water could be obtained. Figure 12 shows an angiogram of a rabbit heart; iodine-based microspheres 15 μm in diameter were used, and fine blood vessels of approximately 100 μm were visible.

4 Conclusion and Outlook

Concerning the spectrum measurement, we obtained fairly clean silver $K\alpha$ rays (22.1 keV). Therefore, we are very interested in the measurement of the $K\alpha$ rays from cerium (34.6 keV) and tungsten (58.9 keV) targets. The target element should be selected corresponding to the radiographic objectives. In medical applications, K-series characteristic x-rays of cerium are absorbed effectively by an iodine-based contrast medium with a K-edge of 33.2 keV, and K-edge angiography can be performed.

In this research, the instantaneous number of generator-produced $K\alpha$ photons was approximately 4×10^7 photons/cm² per pulse 0.3 m from the source. However, the intensity can be increased by increasing the electrostatic energy in condensers in the surge generator, and quasimonochromatic x-rays of both $K\alpha$ and $K\beta$ (24.9 keV) lines are produced without using the palladium filter with a K-edge of 24.3 keV.

Using this flash x-ray generator, because the photon energy of characteristic x-rays can be selected, a high-speed photon-counting radiography system can be performed to decrease noise from radiograms. As compared with a steady state x-ray generator, since the target element can be changed easily using this demountable PMMA tube, demonstrations of monochromatic radiography will be accomplished easily.

Acknowledgment

This work was supported by Grants-in-Aid for Scientific Research (13470154, 13877114, and 16591222) and Advanced Medical Scientific Research from MECSS, Health and Labor Sciences Research Grants (RAMT-nano-001, RHGTEFB-genome-005, and RHGTEFB-saisei-003), grants from the Keiryō Research Foundation, the Promotion and Mutual Aid Corporation for Private Schools of Japan, Japan Science and Technology Agency (JST), and New Energy and Industrial Technology Development Organization (NEDO, Industrial Technology Research Grant Program in 2003).

References

1. A. C. Thompson, H. D. Zeman, G. S. Brown, J. Morrison, P. Reiser, V. Padmanabhan, L. Ong, S. Green, J. Giacomini, H. Gordon, and E. Rubenstein, "First operation of the medical research facility at the NSLS for coronary angiography," *Rev. Sci. Instrum.* **63**, 625–628 (1992).
2. H. Mori, K. Hyodo, E. Tanaka, M. U. Mohammed, A. Yamakawa, Y. Shinozaki, H. Nakazawa, Y. Tanaka, T. Sekka, Y. Iwata, S. Honda, K. Umetani, H. Ueki, T. Yokoyama, K. Tanioka, M. Kubota, H. Hosaka, N. Ishizawa, and M. Ando, "Small-vessel radiography in situ with monochromatic synchrotron radiation," *Radiology* **201**, 173–177 (1996).
3. K. Hyodo, M. Ando, Y. Oku, S. Yamamoto, T. Takeda, Y. Itai, S. Ohtsuka, Y. Sugishita, and J. Tada, "Development of a two-dimensional imaging system for clinical applications of intravenous coronary angiography using intense synchrotron radiation produced by a multipole wiggler," *J. Synchrotron Radiat.* **5**, 1123–1126 (1998).
4. E. Sato, S. Kimura, S. Kawasaki, H. Isobe, K. Takahashi, Y. Tamakawa, and T. Yanagisawa, "Repetitive flash x-ray generator utilizing a simple diode with a new type of energy-selective function," *Rev. Sci. Instrum.* **61**, 2343–2348 (1990).
5. E. Sato, M. Sagae, K. Takahashi, T. Oizumi, H. Ojima, K. Takayama, Y. Tamakawa, T. Yanagisawa, A. Fujiwara, and K. Mitoya, "High-speed soft x-ray generators in biomedicine," *Proc. SPIE* **2513**, 649–667 (1994).
6. E. Sato, M. Sagae, K. Takahashi, A. Shikoda, T. Oizumi, H. Ojima, K. Takayama, Y. Tamakawa, T. Yanagisawa, A. Fujiwara, and K. Mitoya, "Dual energy flash x-ray generator," *Proc. SPIE* **2513**, 723–735 (1994).
7. A. Shikoda, E. Sato, M. Sagae, T. Oizumi, Y. Tamakawa, and T. Yanagisawa, "Repetitive flash x-ray generator having a high-durability diode driven by a two-cable-type line pulser," *Rev. Sci. Instrum.* **65**, 850–856 (1994).
8. E. Sato, K. Takahashi, M. Sagae, S. Kimura, T. Oizumi, Y. Hayasi, Y. Tamakawa, and T. Yanagisawa, "Sub-kilohertz flash x-ray generator utilizing a glass-enclosed cold-cathode triode," *Med. Biol. Eng. Comput.* **32**, 289–294 (1994).
9. K. Takahashi, E. Sato, M. Sagae, T. Oizumi, Y. Tamakawa, and T. Yanagisawa, "Fundamental study on a long-duration flash x-ray generator with a surface-discharge triode," *Jpn. J. Appl. Phys., Part 1* **33**, 4146–4151 (1994).
10. E. Sato, Y. Hayasi, E. Tanaka, H. Mori, T. Kawai, T. Usuki, K. Sato, H. Obara, T. Ichimaru, K. Takayama, H. Ido, and Y. Tamakawa, "Quasi-monochromatic radiography using a high-intensity quasi-x-ray laser generator," *Proc. SPIE* **4682**, 538–548 (2002).
11. E. Sato, Y. Hayasi, R. Germer, E. Tanaka, H. Mori, T. Kawai, H. Obara, T. Ichimaru, K. Takayama, and H. Ido, "Intense characteristic x-ray irradiation from weakly ionized linear plasma and applications," *Jpn. J. Med. Imag. Inform. Sci.* **20**, 148–155 (2003).
12. E. Sato, Y. Hayasi, R. Germer, E. Tanaka, H. Mori, T. Kawai, H. Obara, T. Ichimaru, K. Takayama, and H. Ido, "Irradiation of intense characteristic x-rays from weakly ionized linear molybdenum plasma," *Jpn. J. Med. Phys.* **23**, 123–131 (2003).
13. E. Sato, Y. Hayasi, R. Germer, E. Tanaka, H. Mori, T. Kawai, T. Ichimaru, K. Takayama, and H. Ido, "Quasi-monochromatic flash x-ray generator utilizing weakly ionized linear copper plasma," *Rev. Sci. Instrum.* **74**, 5236–5240 (2003).
14. E. Sato, Y. Hayasi, R. Germer, E. Tanaka, H. Mori, T. Kawai, T. Ichimaru, S. Sato, K. Takayama, and H. Ido, "Sharp characteristic x-ray irradiation from weakly ionized linear plasma," *J. Electron Spectrosc. Relat. Phenom.* **137–140**, 713–720 (2004).
15. A. Mattsson, "Some characteristics of a 600 kV flash x-ray tube," *Phys. Scr.* **5**, 99–102 (1972).
16. R. Germer, "X-ray flash techniques," *J. Phys. E* **12**, 336–350 (1979).
17. B. K. Agarwal, *X-Ray Spectroscopy*, 2nd ed., p. 18, Springer-Verlag, New York (1991).

18. E. Sato, K. Sato, and Y. Tamakawa, "Film-less computed radiography system for high-speed Imaging," *Ann. Rep. Iwate Med. Univ. Sch. Lib. Arts Sci.* 35, 13-23 (2000).

Eiichi Sato received his BS, MS, and PhD in applied physics from Tohoku Gakuin University, Sendai, Japan, in 1979, 1982, and 1987, respectively. He is currently a professor in the Department of Physics at Iwate Medical University. He has written approximately 400 publications and delivered some 200 international presentations concerning x-rays. His research interests include soft flash x-ray generators, quasi-x-ray laser generators, and high-speed radiography. In 2000, he received the Schardin Gold Medal from the German Physical Society, in 2003 he received the Takayama Award (Gold Medal) from the Japan Society of High Speed Photography and Photonics, and he received the Honorable Mention Poster Award from the SPIE International Symposium on Medical Imaging 2005.

Yasuomi Hayasi received his BS, MS, and PhD degrees in physics from Tohoku University in 1962, 1964, and 1967, respectively. Since 1990 he has been a professor in the Department of Electrical Engineering at Hachinohe National College of Technology, Japan. Since 2003 he has been a visiting professor at the Department of Physics, Iwate Medical University. His research interests include x-ray spectroscopy.

Rudolf Germer received his diploma, PhD, and habile degrees in physics in 1971, 1974, and 1979 at the Free and Technical Universities of Berlin. He was a visiting professor at the University of Oldenburg (Germany) and ODU Norfolk, and did research at the Fritz-Haber Institute (MPI Berlin). He was professor at the University of Applied Science Telekom Berlin and is now at the FHTW and TU Berlin. He is president of the Institute of Technical Physics e.V. His research interests include areas of technical physics such as x-ray flashes, pulsed power, solid state and plasma physics, sound, and high-speed videography. He received the High-Speed Imaging Award 2003 of Japan.

Etsuro Tanaka received his MD and PhD degrees in medicine from Kumamoto University, Japan, in 1980 and 1986, respectively. He worked on medical image processing in the Department of Physiology, Tokai University, Japan, from 1988 to 2003. He is currently a professor in the Department of Nutritional Sciences, Tokyo University of Agriculture, Japan. His research interests include medical image processing, human physiology, and clinical nutrition.

Hidezo Mori received a medical degree from Keio University School of Medicine, Tokyo, Japan, in 1977, and also a PhD from the Post Graduate School, Keio University School of Medicine. Now he is the director of the Department of Cardiac Physiology at the National Cardiovascular Center, Suita, Japan. His primary research interests are regenerative therapy in cardiovascular disease, microcirculation, and medical applications of structural biology.

Toshiaki Kawai received the BS degree in precision mechanics and the MS degree in electronic engineering from Shizuoka University, Hamamatsu, Japan in 1964 and 1974, respectively. In 1974, he joined the Hamamatsu Photonics K.K., where he worked on research and development of solid-state infrared detectors. From 1978 to 1981, he engaged in research work on the NEA cold cathode for application to imaging camera tubes. He is now the project coordinator of the Electron Tube Division 2 and is engaged in the development and manufacturing of imaging devices and x-ray equipment. He is a member of the Japan Radioisotope Association and the Institute of Image Information and Television Engineers of Japan.

Takashi Inoue received his MD and PhD degrees in 2000 from Tohoku University. He is currently an assistant professor in the Department of Neurosurgery at Iwate Medical University, and a member of the Japan Neurosurgical Society. His research interests include neurosurgery and MRI.

Akira Ogawa received his MD and PhD degrees in 1981 from Tohoku University. He is currently a professor in the Department of Neurosurgery and Dean of the School of Medicine at Iwate Medical University, and is a trustee of the Japan Neurosurgical Society. His research interests include neurosurgery and cerebrovascular disease.

Shigehiro Sato received his MD degree from Iwate Medical University in 1980. He worked for the laboratory of the Division of Pediatric Infectious Diseases at Johns Hopkins Hospital from 1985 to 1989. He is currently a professor in the Department of Microbiology at Iwate Medical University. His research interests include central nervous system damage caused by Vero toxin, a cell culture system for vaccine development, and microangiography.

Toshio Ichimaru received his PhD degree in medical science in 1983 from Iwate Medical University. He is currently a professor of Medical Radiological Science, School of Health Sciences, at Hiroasaki University. His research interests include various kinds of x-ray imaging in medicine.

Kazuyoshi Takayama received his BS degree from Nagoya Institute of Technology in 1962. In 1970, he received his PhD in mechanical engineering from Tohoku University. He is currently a director (professor) in the Shock Wave Research Center, Institute of Fluid Science at Tohoku University. His research interests include various shock wave phenomena, high-speed photography, and flash radiography. He has received seven awards including the coveted Ernst Mach Medal in 2000.

Jun Onagawa received his BS and PhD degrees in applied physics from Tohoku Gakuin University in 1968 and 2001, respectively. He is currently a professor in the Department of Applied Physics and Informatics, Faculty of Engineering at Tohoku Gakuin University. His research interests include target metallography and x-ray spectroscopy.

Hideaki Ido received his BS, MS, and PhD degrees in physics from Tohoku University in 1962, 1964, and 1967, respectively. He is currently a professor in the Department of Applied Physics and Informatics, Faculty of Engineering at Tohoku Gakuin University. His research interests include magnetism and x-ray spectroscopy.

X-ray spectra from a cerium target and their application to cone beam K-edge angiography

Eiichi Sato, MEMBER SPIE
Iwate Medical University
Department of Physics
Morioka 020-0015, Japan
E-mail: dresato@iwate-med.ac.jp

Akira Yamadera
Hirosaki University
Department of Radiological Technology
School of Health Sciences
Hirosaki 036-8564, Japan

Etsuro Tanaka
Tokyo University of Agriculture
Department of Nutritional Science
Faculty of Applied Bioscience
Setagaya-ku 156-8502, Japan

Hidezo Mori
National Cardiovascular Center Research Institute
Department of Cardiac Physiology
Osaka 565-8565, Japan

Toshiaki Kawai, MEMBER SPIE
Hamamatsu Photonics K. K.
Electron Tube Division 2
Iwata 438-0193, Japan

Fumihito Ito
Digital Culture Technology Corporation
Kanno The 2nd Building.
Morioka 020-0021, Japan

Takashi Inoue
Akira Ogawa
Iwate Medical University
Department of Neurosurgery
School of Medicine
Morioka 020-8505, Japan

Shigehiro Sato
Iwate Medical University
Department of Microbiology
School of Medicine
Morioka 020-8505, Japan

Kazuyoshi Takayama, MEMBER SPIE
Tohoku University
Shock Wave Research Center
Institute of Fluid Science
Sendai 980-8577, Japan

Jun Onagawa
Hideaki Ido
Tohoku Gakuin University
Department of Applied Physics and Informatics
Faculty of Engineering
Tagajo 985-8537, Japan

Abstract. The cerium-target x-ray tube is useful for performing cone beam K-edge angiography, because K-series characteristic x-rays from the cerium target are absorbed effectively by iodine-based contrast media. The x-ray generator consists of a main controller and a unit with a high-voltage circuit and a fixed anode x-ray tube. The tube is a glass-enclosed diode with a cerium target and a 0.5-mm-thick beryllium window. The maximum tube voltage and current are 65 kV and 0.4 mA, respectively, and the focal-spot sizes are 1.3×0.9 mm. Cerium K-series characteristic x-rays are left, using a 3.0-mm-thick aluminum filter, and the x-ray intensity is $19.9 \mu\text{Gy/s}$ at 1.0 m from the source with a tube voltage of 60 kV and a current of 0.40 mA. Angiography is performed with a computed radiography system using iodine-based microspheres $15 \mu\text{m}$ in diameter. In angiography of nonliving animals, we observe fine blood vessels of approximately $100 \mu\text{m}$ with high contrasts. © 2005 Society of Photo-Optical Instrumentation Engineers. [DOI: 10.1117/1.2049268]

Subject terms: x-ray tube; cerium target; quasimonochromatic x-rays; characteristic x-rays; K-edge angiography.

Paper 040733R received Oct. 6, 2004; revised manuscript received Mar. 8, 2005; accepted for publication Mar. 11, 2005; published online Sep. 16, 2005. This paper is a revision of a paper presented at the SPIE conference on X-Ray Sources and Optics, August 2004, Denver, CO. The paper presented there appears (unrefereed) in SPIE Proceedings Vol. 5537.

1 Introduction

Monochromatic parallel x-ray beams are the basis of radiography using synchrotrons in conjunction with single crystals, and these beams have been employed to perform enhanced K-edge angiography¹⁻³ and x-ray phase imaging.⁴⁻⁶ In angiography, the beams with photon energies of approximately 35 keV are absorbed effectively by iodine-based contrast media. However, it is difficult to obtain sufficient machine times for various research projects, including medical applications. Subsequently, monochromatic cone beams with energies of approximately 35 keV are useful for increasing the irradiation field for K-edge angiography.

To perform high-speed medical radiography, although several different flash x-ray generators⁷⁻¹³ utilizing cold-cathode tubes have been developed, plasma flash x-ray generators¹⁴⁻¹⁸ are useful for producing quasimonochromatic x-rays without using a K-edge filter. Therefore, we have performed a demonstration of cone beam K-edge

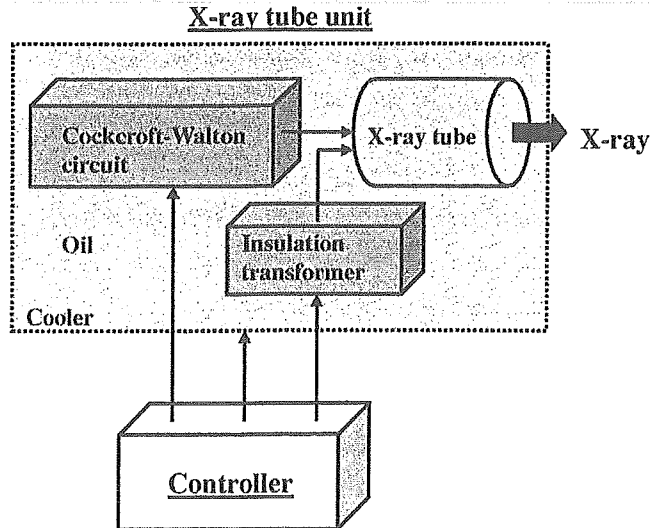

Fig. 1 Block diagram of the compact x-ray generator with a cerium-target radiation tube, which is used specially for K-edge angiography using iodine-based contrast media.

angiography¹⁹ utilizing a cerium plasma generator, since K-series characteristic x-rays from the cerium target are absorbed effectively by iodine.

Recently, we have developed a steady-state x-ray generator utilizing a cerium-target tube, and have demonstrated enhanced K-edge angiography utilizing cerium $K\alpha$ lines (34.6 keV).²⁰ In this research, $K\alpha$ lines were left by absorbing $K\beta$ lines (39.2 keV) using a barium sulfate filter with a barium K edge of 37.4 keV. However, because cerium $K\beta$ lines are also absorbed effectively by iodine, both $K\alpha$ and

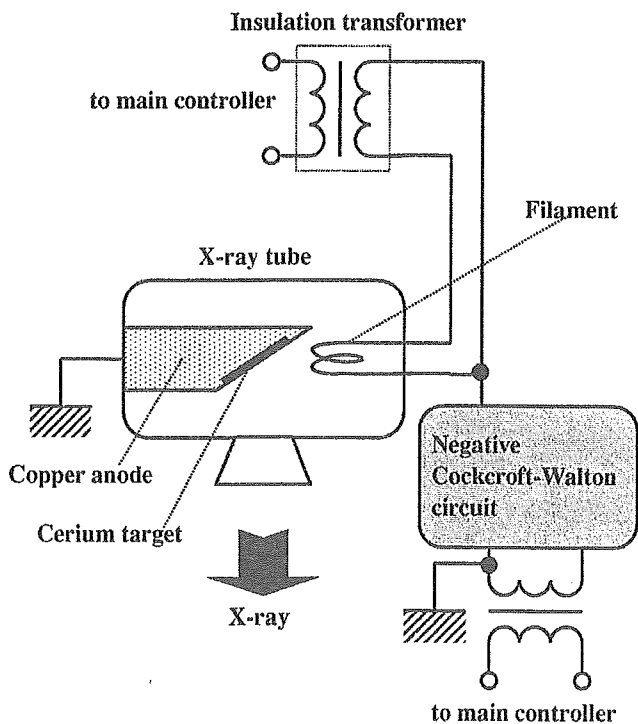

Fig. 2 Main circuit of the x-ray generator.

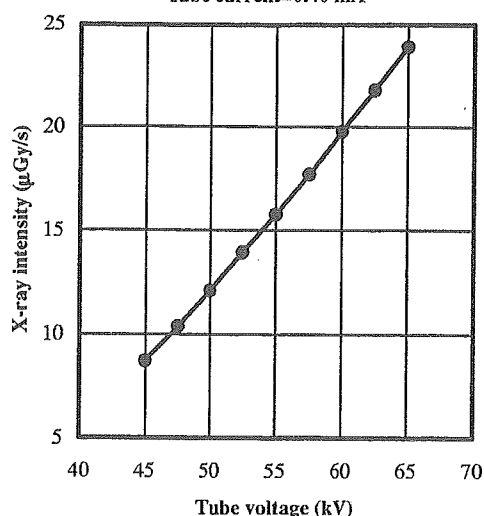

Fig. 3 The x-ray intensity ($\mu\text{Gy/s}$) as a function of tube voltage (kV) with a tube current of 0.40 mA.

$K\beta$ lines can be selected to increase the x-ray intensity for angiography. In measurements of x-ray spectra, although we usually employed a cadmium telluride detector with a photon energy resolution of 1.7 keV, the resolution should be minimized to measure the characteristic x-ray intensity.

In the present research, we measured the x-ray spectra from a cerium-target tube using a germanium detector, and performed a preliminary study on cone beam K-edge angiography achieved with cerium characteristic x-rays without using a K-edge filter.

2 Experimental Setup

Figure 1 shows the block diagram of the x-ray generator, which consists of a main controller and an x-ray tube unit with a Cockcroft-Walton circuit and a cerium-target tube. The tube voltage, the current, and the exposure time can be controlled by the controller. The main circuit for producing x-rays is illustrated in Fig. 2, and employs the Cockcroft-Walton circuit to decrease the dimensions of the tube unit. In the x-ray tube, the negative high voltage is applied to the cathode electrode, and the anode (target) is connected to the tube unit case (ground potential) to cool the anode and the target effectively. The filament heating current is supplied by an AC power supply in the controller in conjunction with an insulation transformer. In this experiment, the tube

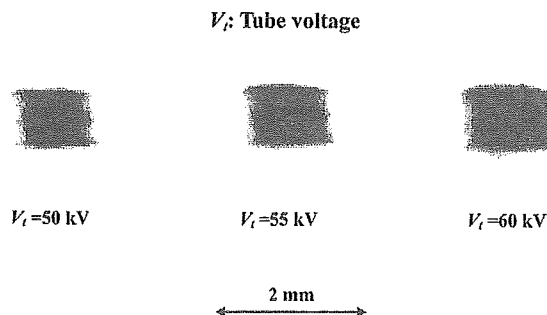

Fig. 4 Effective focal spots with changes in the tube voltage.

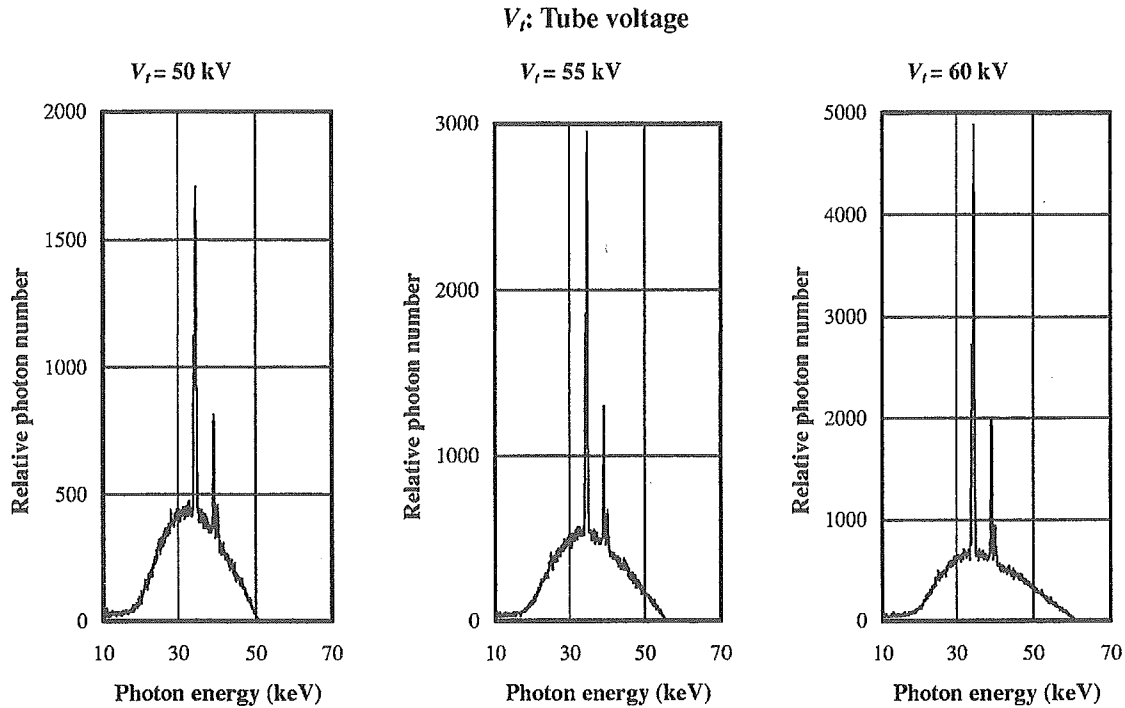

Fig. 5 X-ray spectra measured using a germanium detector with changes in the tube voltage.

voltage applied was from 45 to 65 kV, and the tube current was regulated to within 0.40 mA (maximum current) by the filament temperature. The exposure time is controlled to obtain optimum x-ray intensity. Quasimonochromatic x-rays are produced using a 3.0-mm-thick aluminum filter for absorbing soft bremsstrahlung rays.

3 Results and Discussion

3.1 X-ray Intensity

X-ray intensity was measured by a Victoreen 660 ionization chamber at 1.0 m from the x-ray source using the filter (Fig. 3). At a constant tube current of 0.40 mA, the x-ray intensity increased when the tube voltage was increased. In this measurement, the intensity with a tube voltage of 60 kV and a current of 0.40 mA was $19.9 \mu\text{Gy/s}$ at 1.0 m from the source, with errors of less than 0.2%.

3.2 Focal Spot

To measure images of the x-ray source after the aluminum filtration, we employed a pinhole camera with a hole diameter of $50 \mu\text{m}$ (magnification ratio of 1:2) in conjunction with a computed radiography (CR) system²¹ with a sampling pitch of $87.5 \mu\text{m}$. When the tube voltage was increased, spot dimensions increased slightly and had values of $1.3 \times 0.9 \text{ mm}$ (Fig. 4).

3.3 X-ray Spectra

To measure x-ray spectra, we employed a germanium detector (GLP-10180/07-P, Ortec Incorporated) with a photon energy resolution of approximately 0.12 keV (Fig. 5). When the tube voltage was increased, the characteristic x-ray intensities of $K\alpha$ and $K\beta$ lines substantially increased, and both the maximum photon energy and the intensities of bremsstrahlung x-rays increased. Because the widths of the lines were approximately 1 keV, the photon energy resolution of this detector was an optimum value. In an empirical equation, because the characteristic x-ray in-

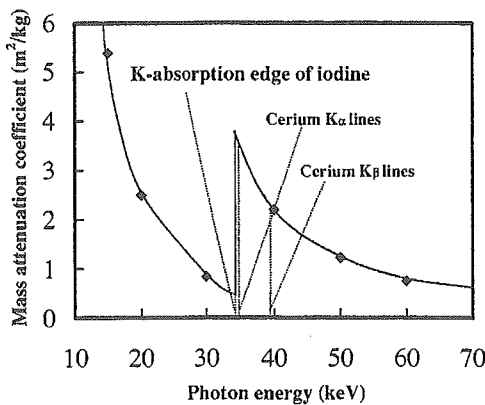

Fig. 6 Mass attenuation coefficients of iodine, and the average photon energies of cerium $K\alpha$ and $K\beta$ lines.

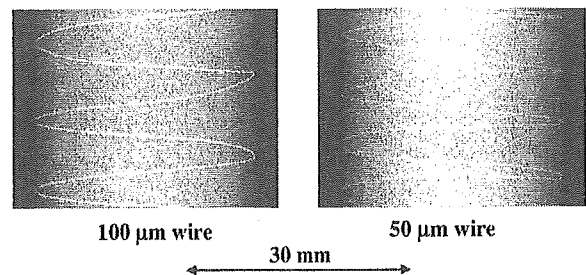

Fig. 7 Radiograms of tungsten wires coiled around PMMA rods with a tube voltage of 60 kV.

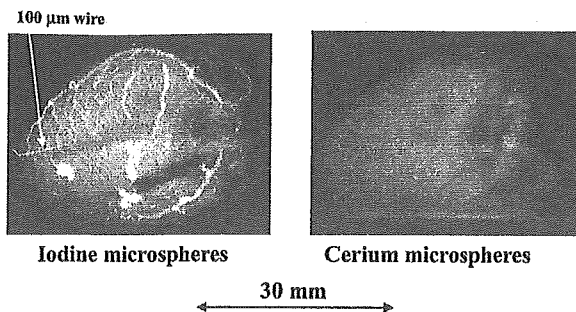

Fig. 8 Angiograms of extracted rabbit hearts using iodine and cerium microspheres with a tube voltage of 60 kV.

tensity is proportional to approximately 1.5 power of the voltage difference between the tube voltage and the critical excitation voltage, the measured intensities of the characteristic x-rays corresponded well to the equation.

3.4 K-Edge Angiography

Figure 6 shows the mass attenuation coefficients of iodine at the selected energies; the coefficient curve is discontinuous at the iodine K edge. The average photon energy of the cerium $K\alpha$ and $K\beta$ lines are shown just above the iodine K edge. The average photon energies of $K\alpha$ and $K\beta$ lines are 34.6 and 39.2 keV, respectively, and iodine contrast media with a K-absorption edge of 33.2 keV absorb the lines easily. Therefore, blood vessels were observed with high contrasts.

The angiography was performed by a CR system (Konica Minolta Regius 150) using the filter, and the distance (between the x-ray source and the imaging plate) was 1.5 m. First, rough measurements of spatial resolution were made using wires. Figure 7 shows radiograms of tungsten wires coiled around a rod made of polymethyl methacrylate. Although the image contrast decreased somewhat with decreases in the wire diameter, due to blurring of the image caused by the sampling pitch of $87.5 \mu\text{m}$, a $50\text{-}\mu\text{m}$ -diam wire could be observed.

Angiograms of rabbit hearts are shown in Fig. 8. These two images were obtained using iodine and cerium microspheres of $15 \mu\text{m}$ in diameter at a tube voltage of 60 kV.

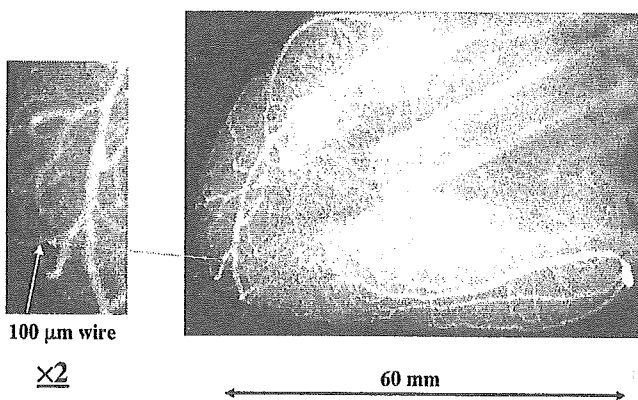

Fig. 9 Angiograms of an extracted dog heart using iodine microspheres with a tube voltage of 60 kV.

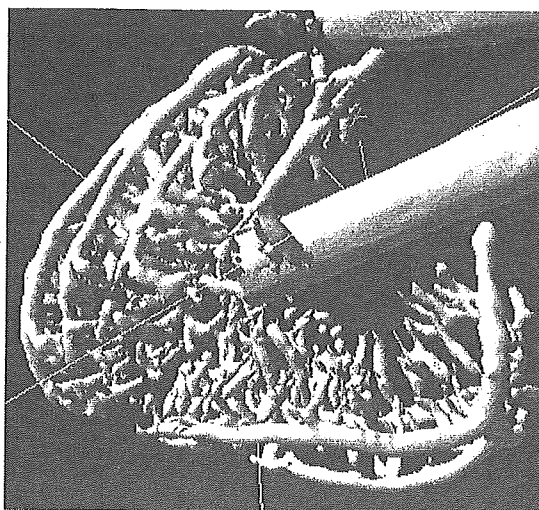

Fig. 10 3-D image of coronary arteries constructed from x-ray CT images by Pascal.

The microspheres are very useful for making phantoms of nonliving animals used for angiography. The iodine plastic spheres contained 37% iodine by weight, and the cerium plastic spheres were chemically stable and contained 18% cerium by weight. In the case where the cerium spheres were employed, the coronary arteries were barely visible, since the cerium spheres transmitted cerium characteristic x-rays easily. Figure 9 shows an angiogram of a larger dog heart at a tube voltage of 60 kV using iodine spheres. For comparison, we show a 3-D image of the coronary arteries constructed from x-ray CT images by Pascal (Digital Culture Technical Corporation) with a tungsten x-ray tube (Fig. 10). Using this imaging technique, fine blood vessels were not observed at all.

4 Conclusion and Outlook

In summary, we employ an x-ray generator with a cerium-target tube and succeed in producing cerium characteristic x-rays, which can be absorbed easily by iodine-based contrast media. The characteristic x-ray intensities increase with increases in the tube voltage, and low-photon-energy bremsstrahlung rays are absorbed effectively by the filter.

Although the cerium x-ray generator used in this research produces both the characteristic and the bremsstrahlung x-rays, bremsstrahlung intensity can be decreased effectively by considering the angle dependence without using the filter, since bremsstrahlung rays are not emitted in the opposite direction to that of electron trajectory in Sommerfeld's theory.²² Subsequently, the generator-produced maximum number of characteristic photons is approximately 3.5×10^7 photons/cm²·s at 1.0 m from the source, and the photon count rate can be increased easily by improving the target.

The x-ray intensity is limited because the thermal contact between the target and the anode is not good. However, the intensity can be increased by welding the target or using a cerium-alloy target. In addition, a rotation anode tube can be developed by the sputtering of cerium.

Compared to the 3-D blood images constructed from x-ray CT images by Pascal, fine blood vessels are visible.