

年間収容患者数

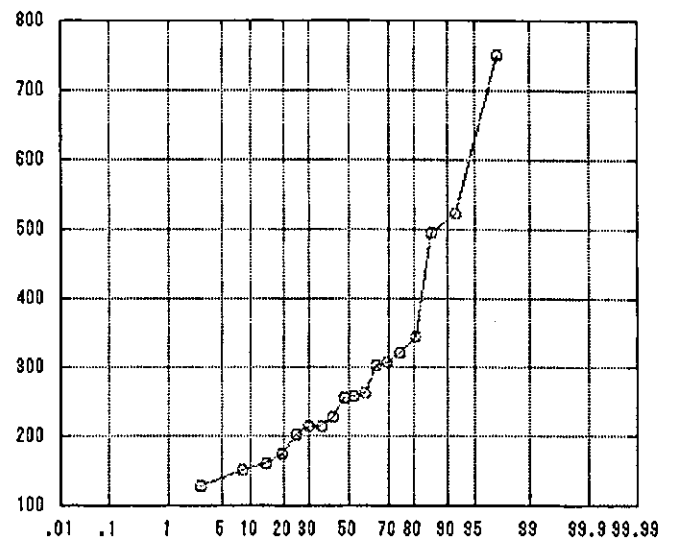

APACHE 0~4

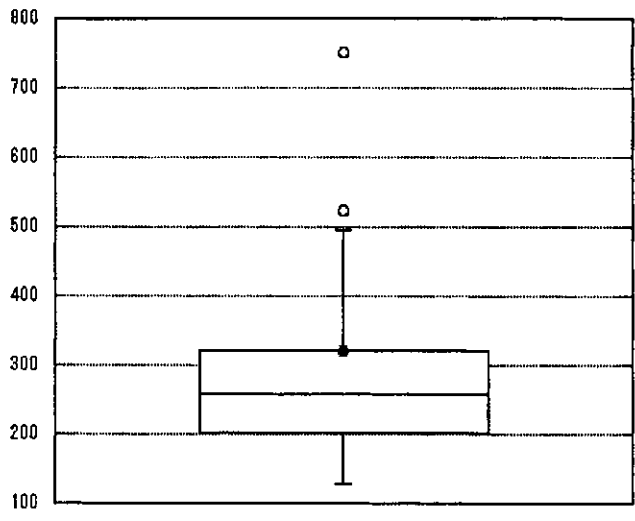
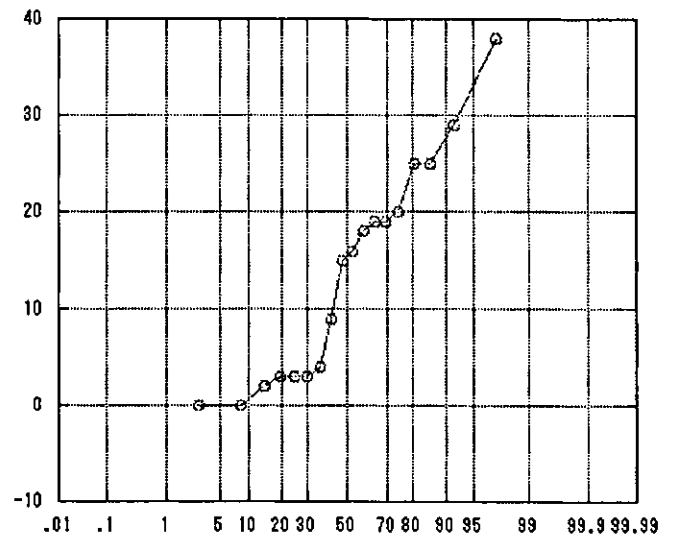
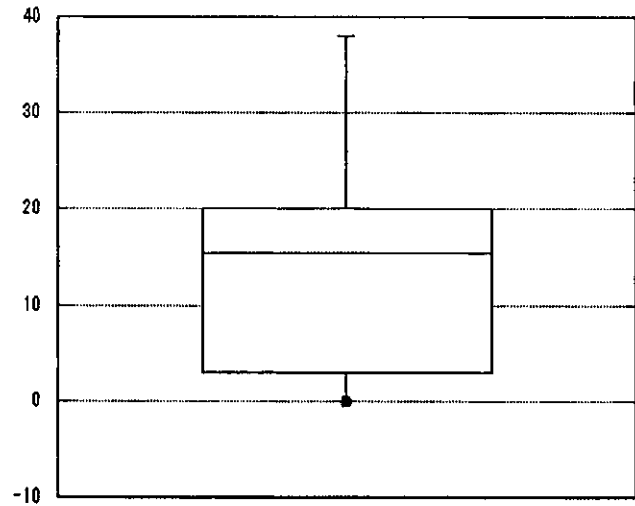

APACHE 5~9

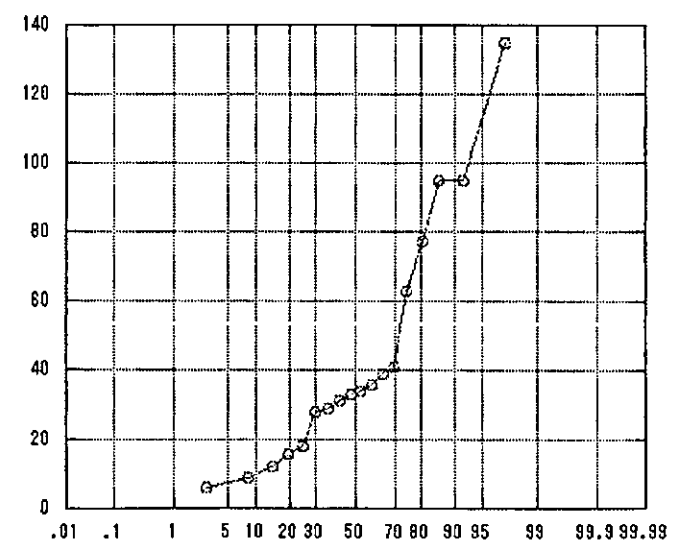
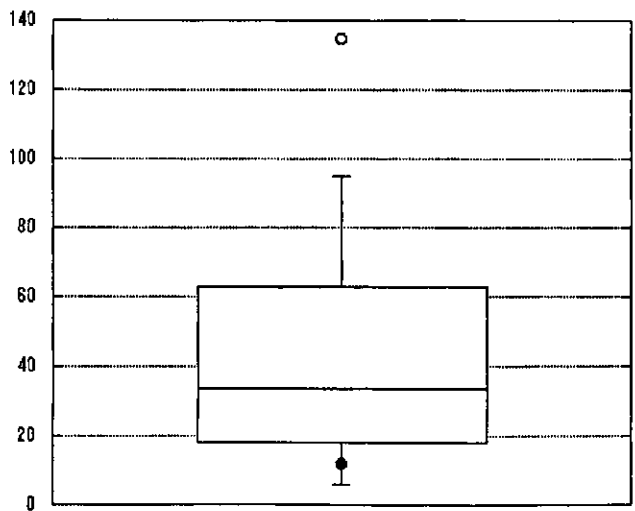

● 自施設

APACHE 10~14

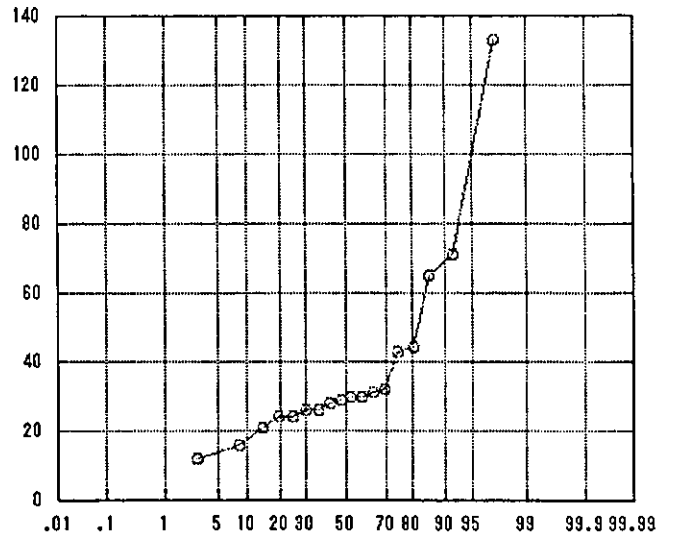
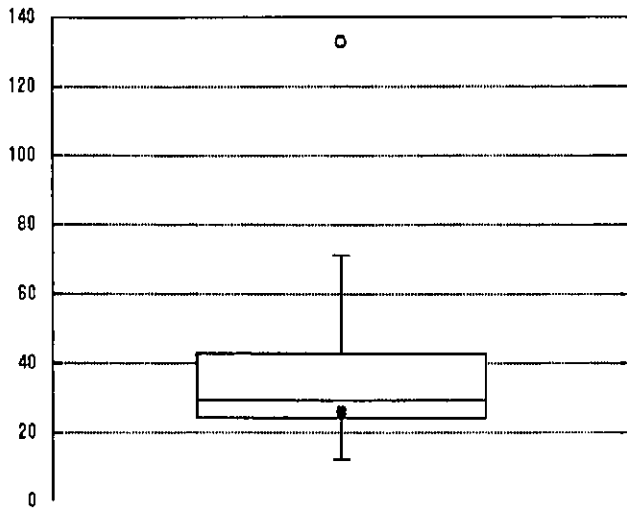

APACHE 15~19

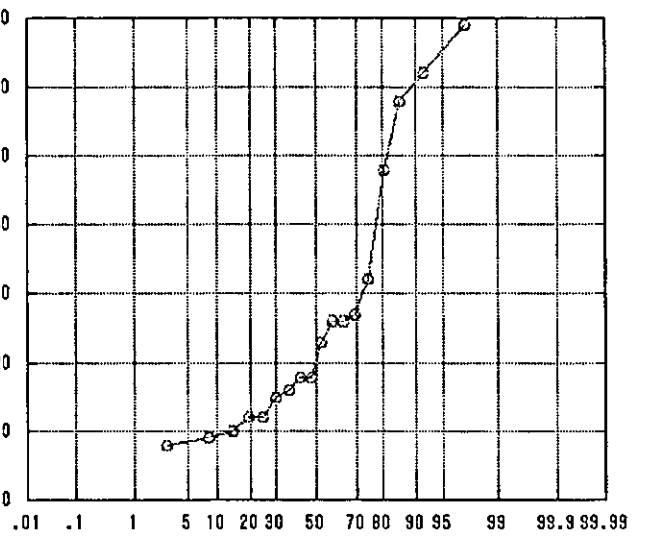
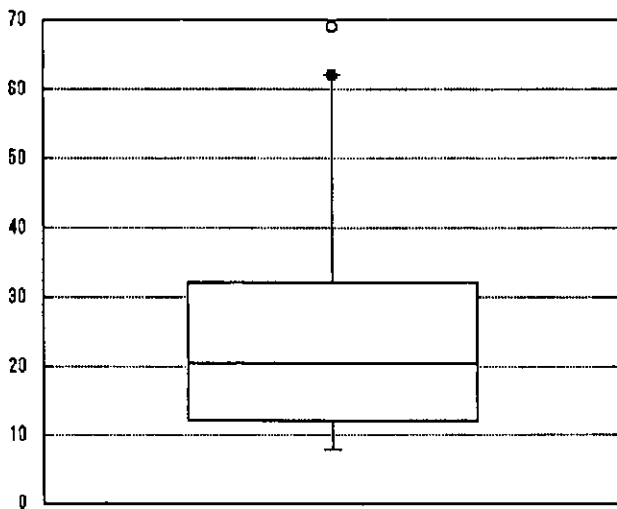

APACHE 20~24

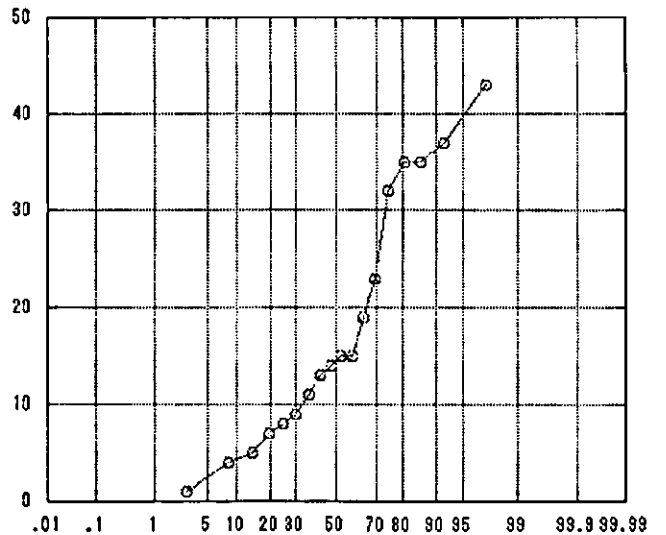
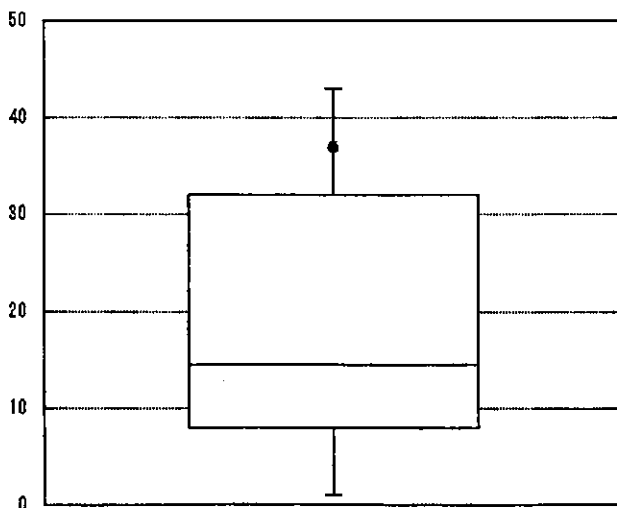

● 自施設

APACHE 25~29

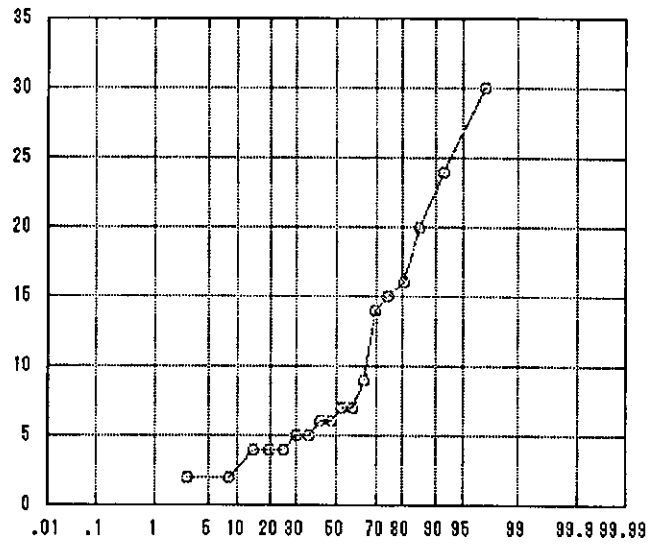
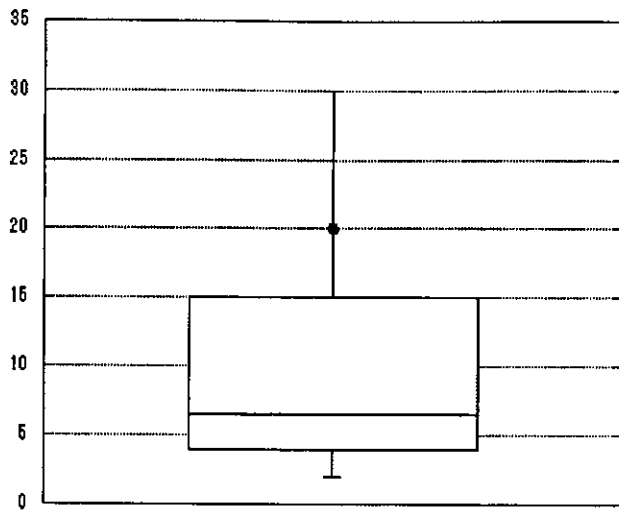

APACHE 30~34

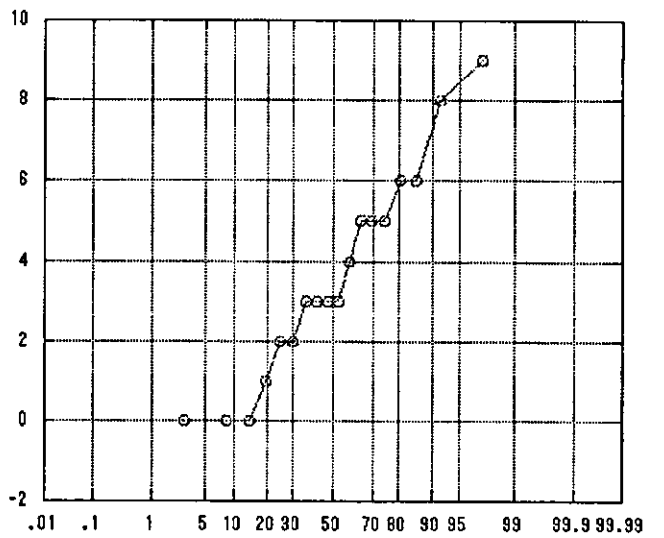
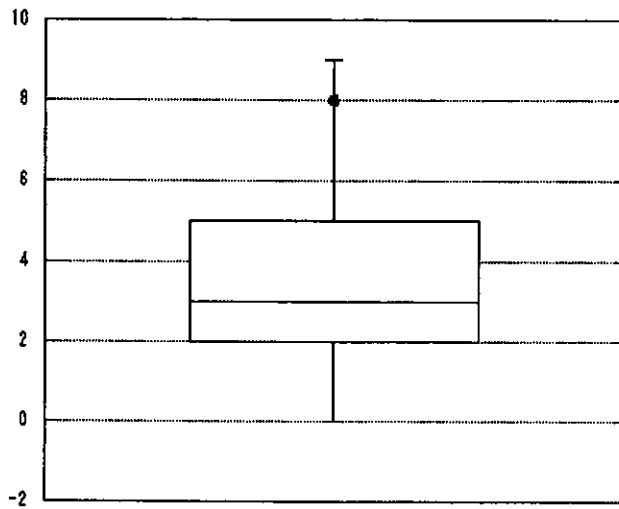

APACHE 35~

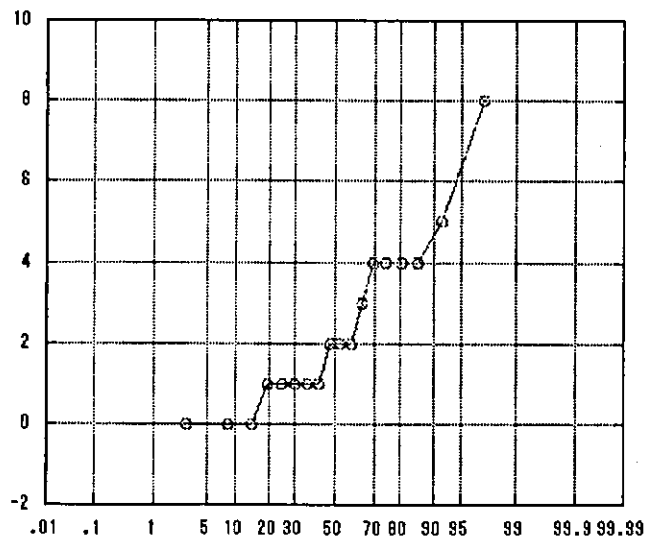
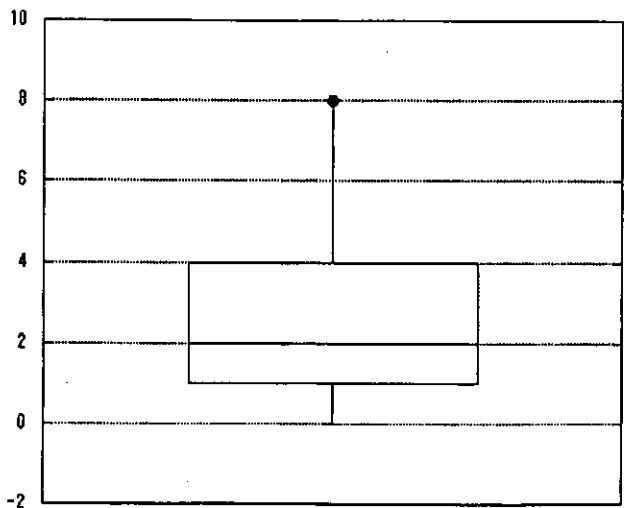

● 自施設

パーセント

APACHE平均

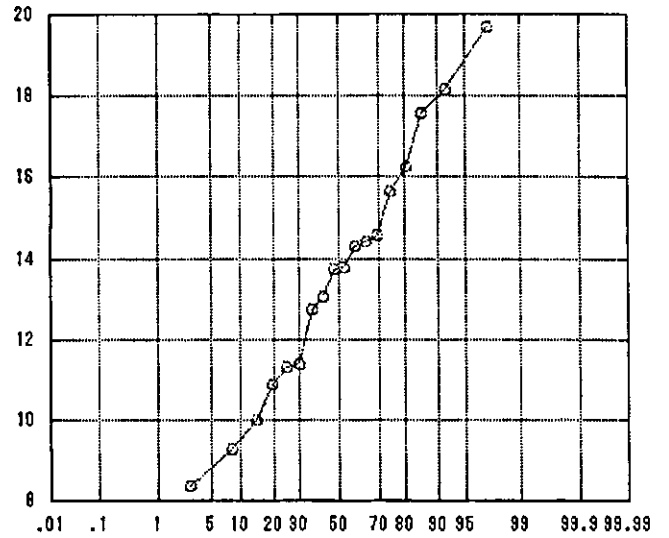
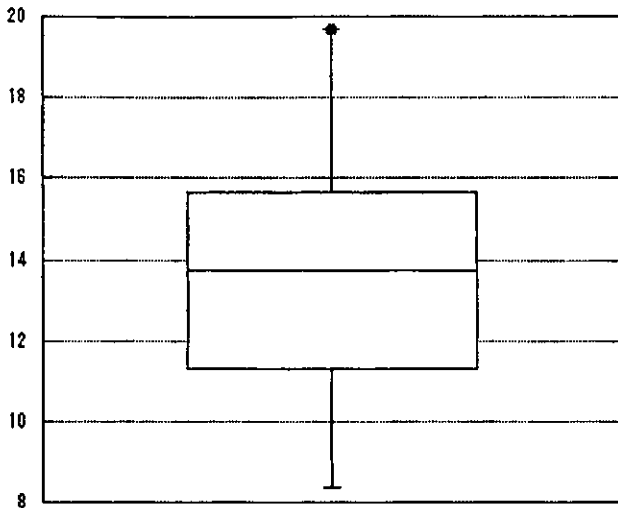

標準化死亡比

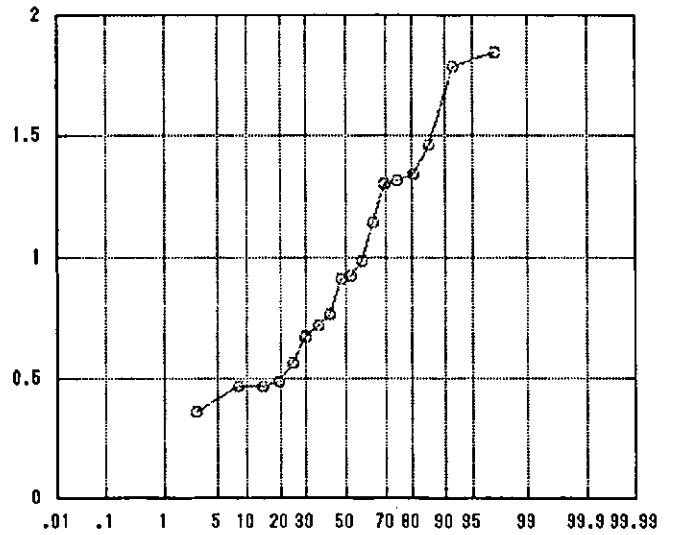
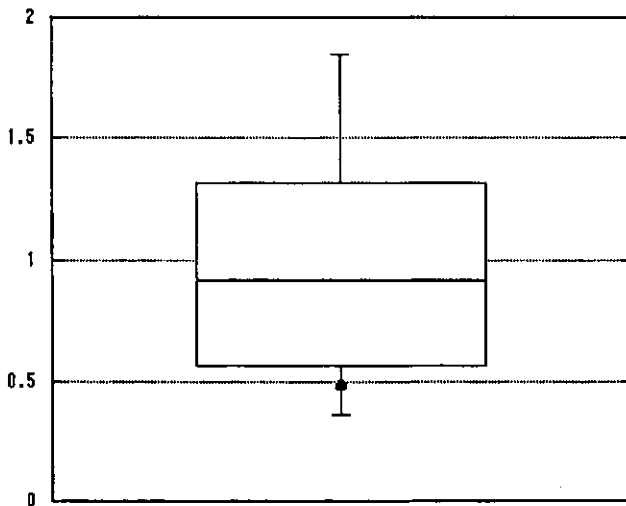

平均在室日数

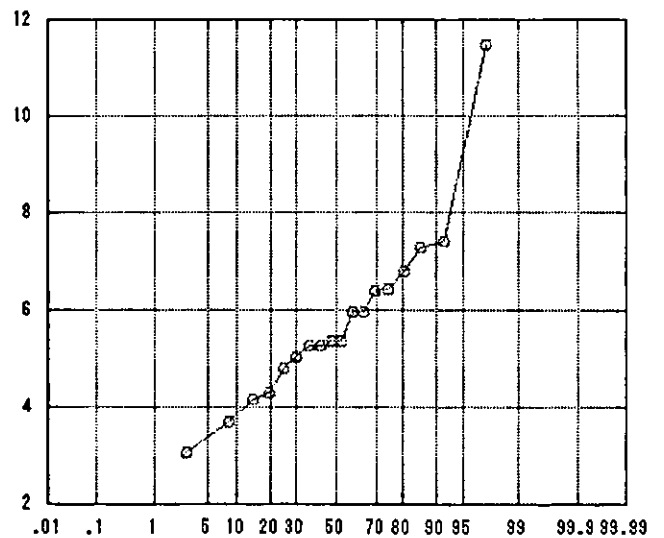
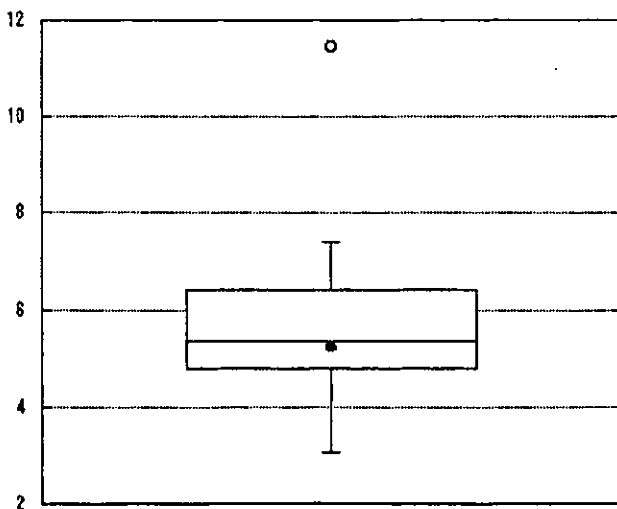

● 自施設

パーセント

平均在院日数

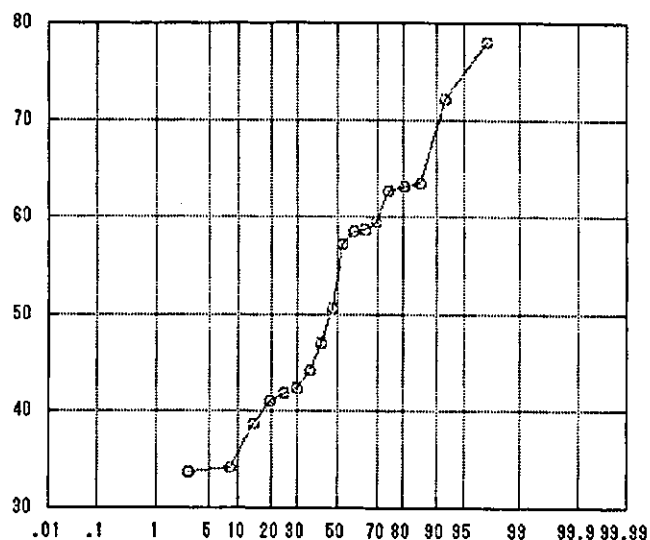
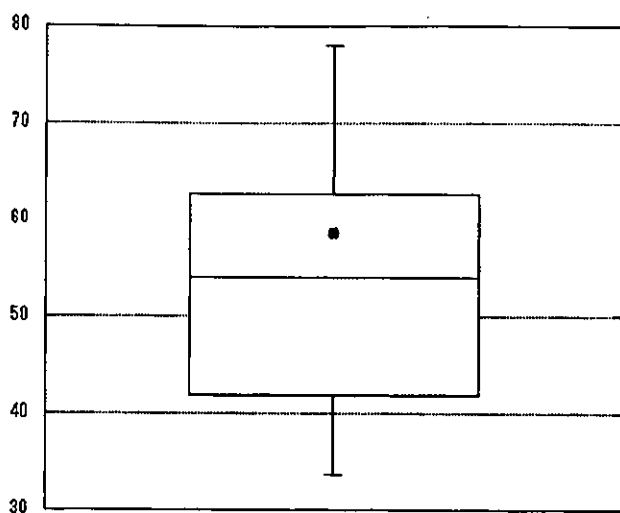

人工呼吸器利用率

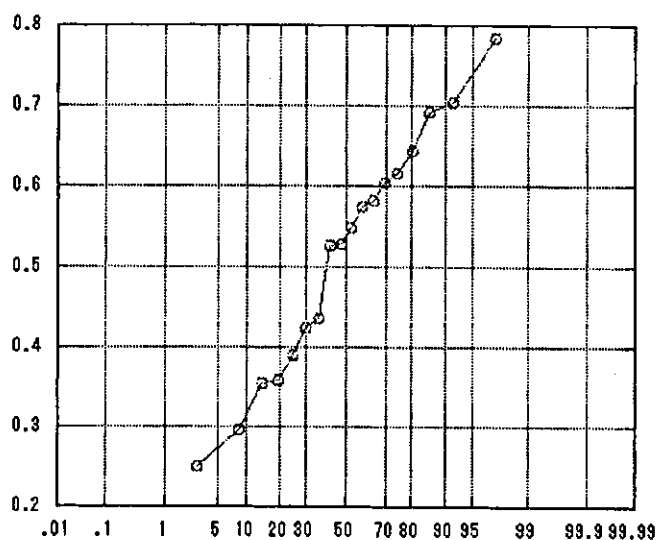
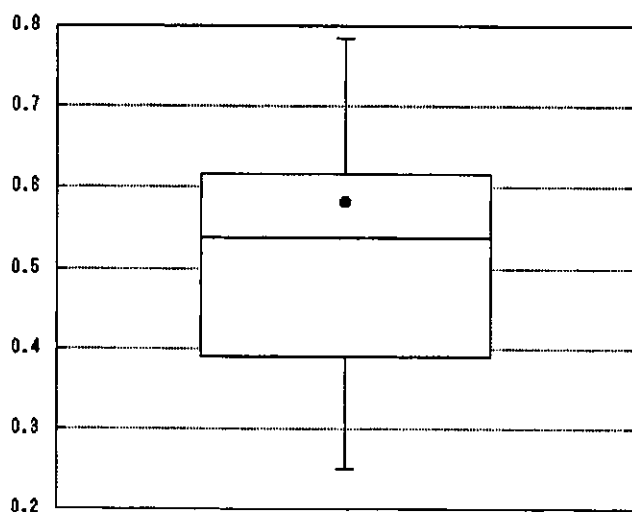

中心静脈カテ利用率

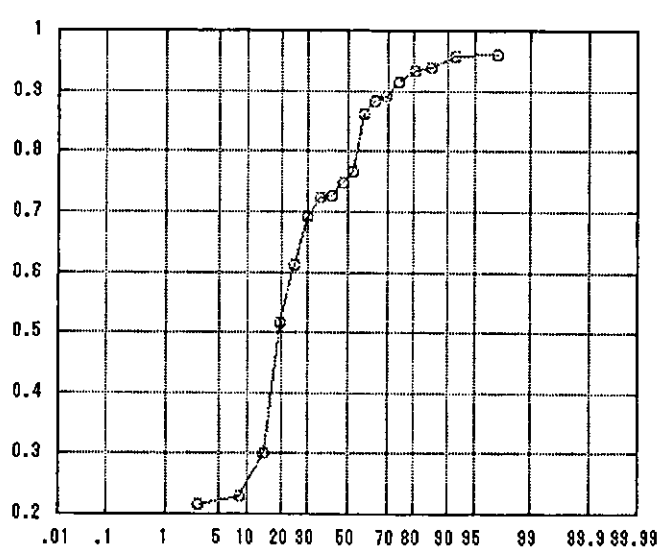
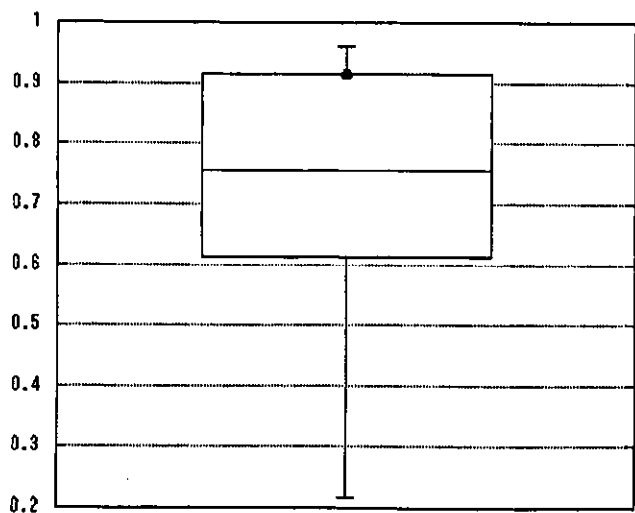

● 自施設

パーセント

尿道カテ利用率

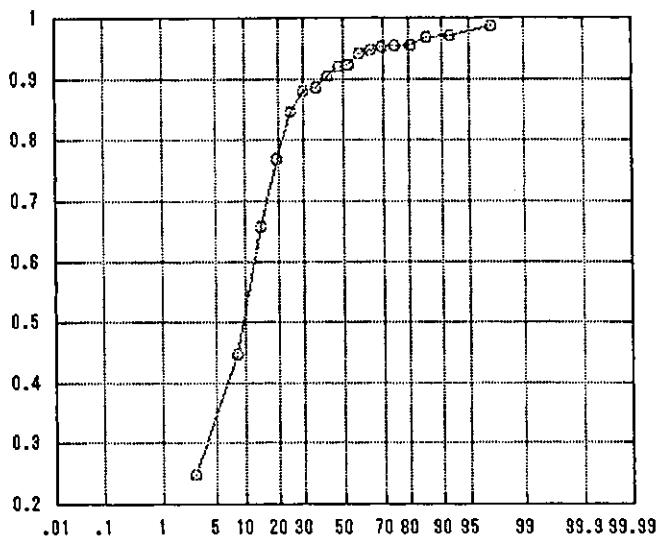
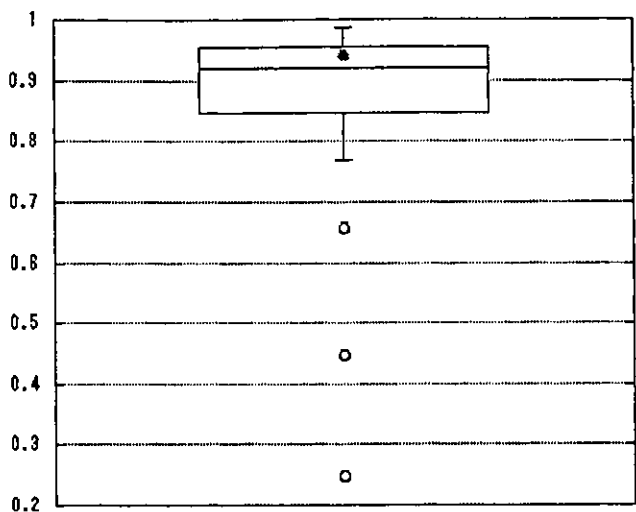

人工呼吸日／患者数

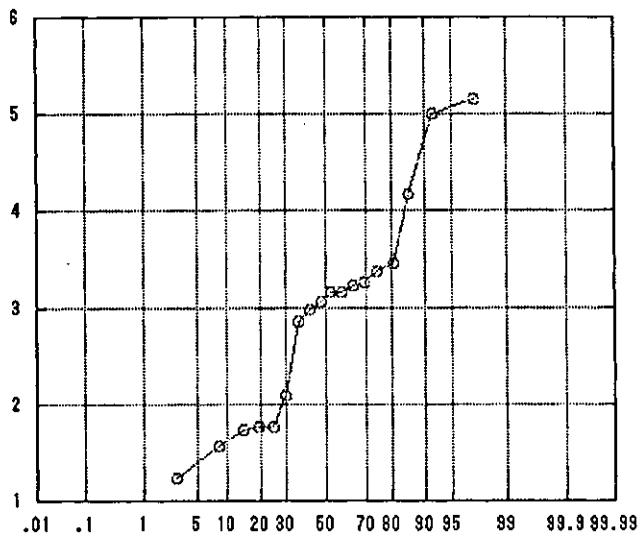
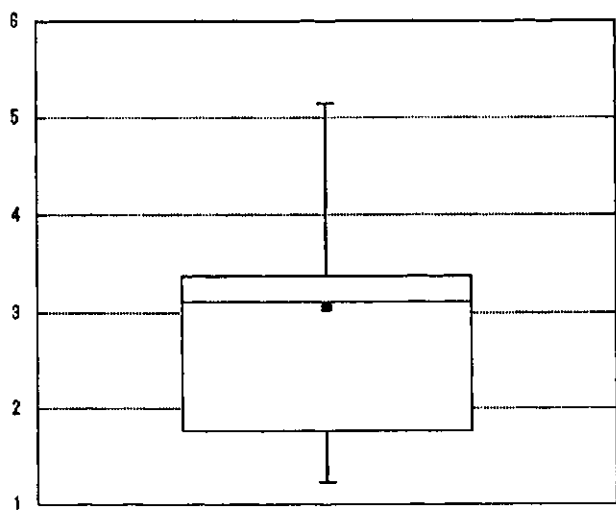

リスク調整感染率（肺炎）

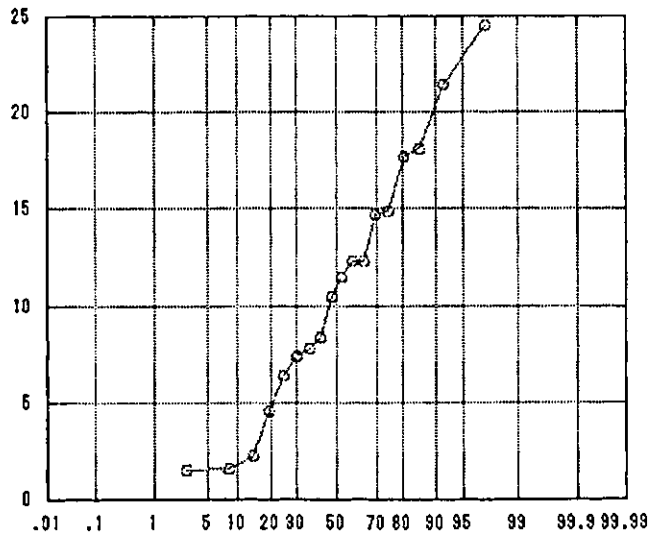
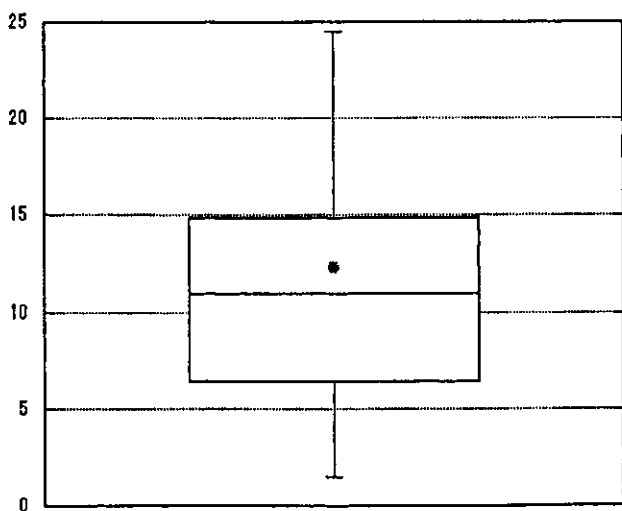

● 自施設

パーセント

リスク調整感染率 (カテ)

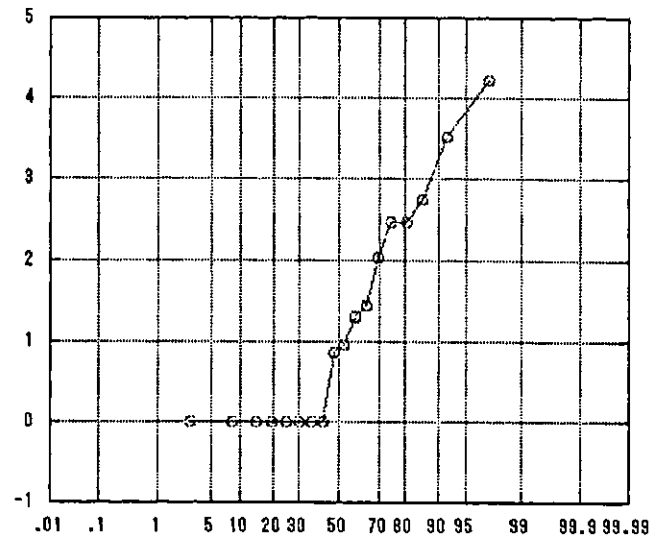
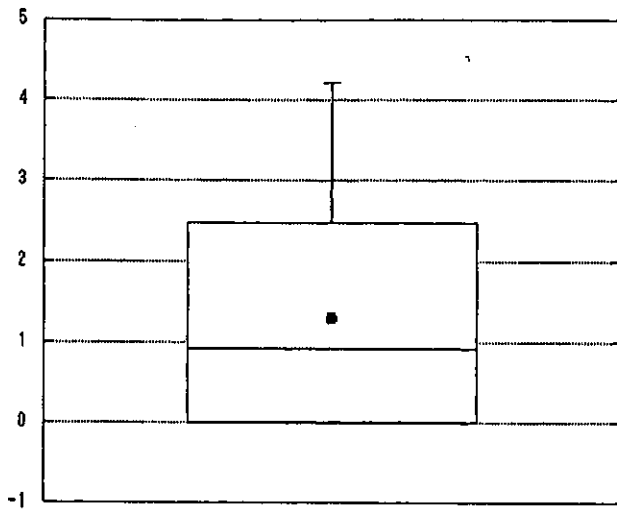

リスク調整感染率 (尿路)

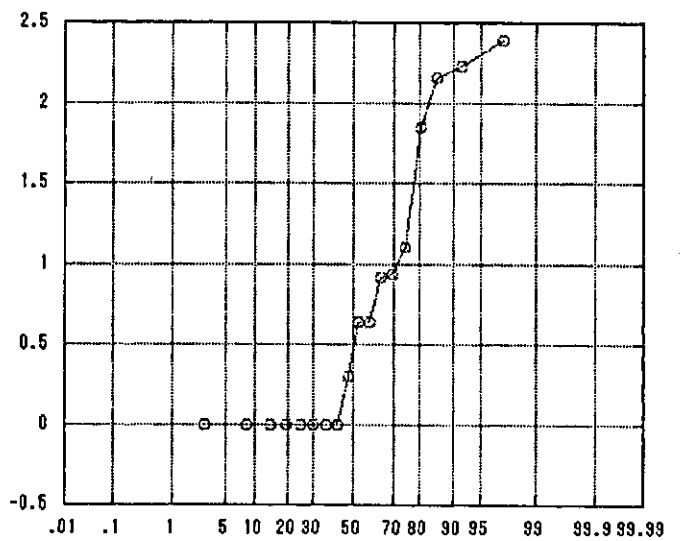
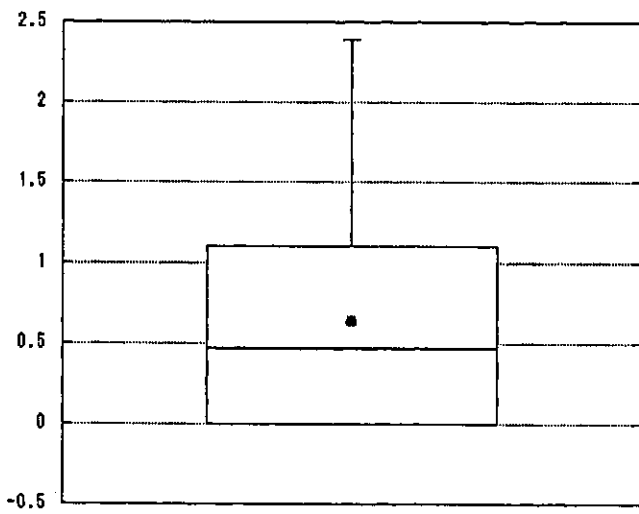

全感染率 (耐性)

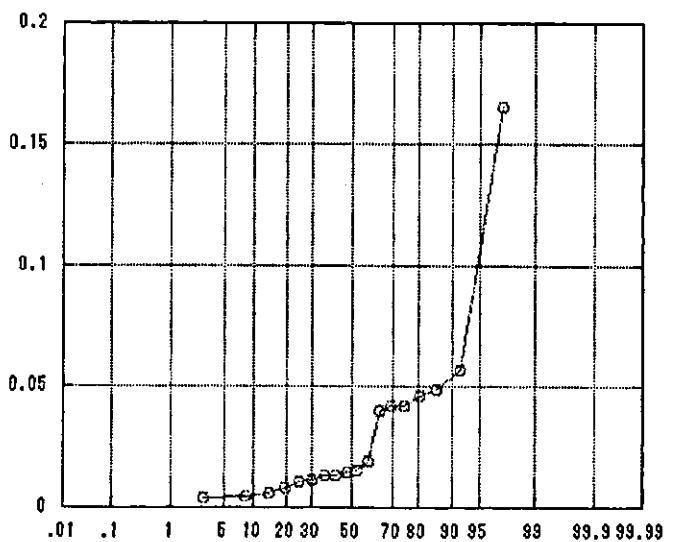
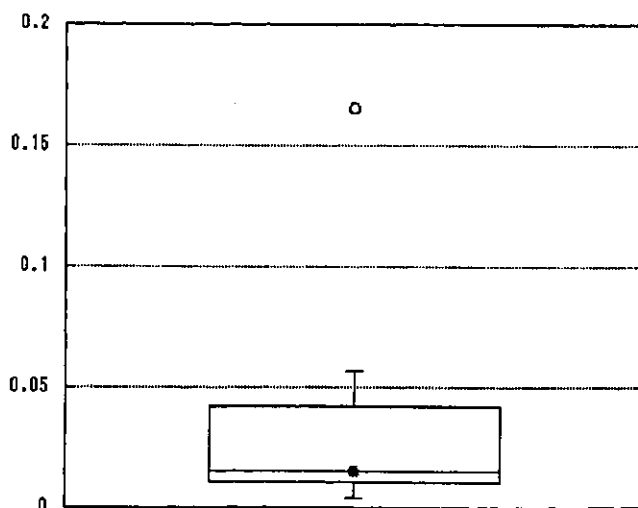

● 自施設

全感染率（感性）

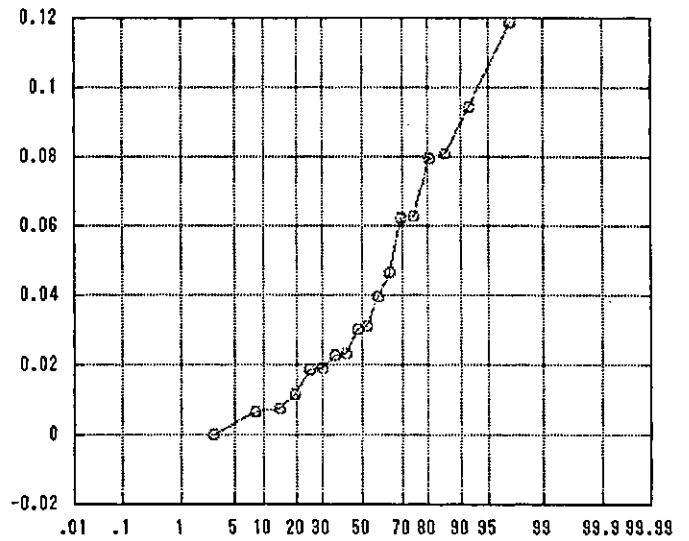
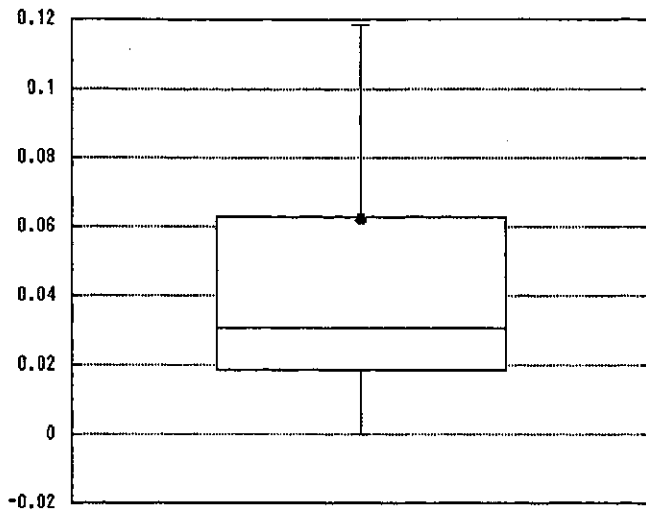

肺炎感染率（耐性）

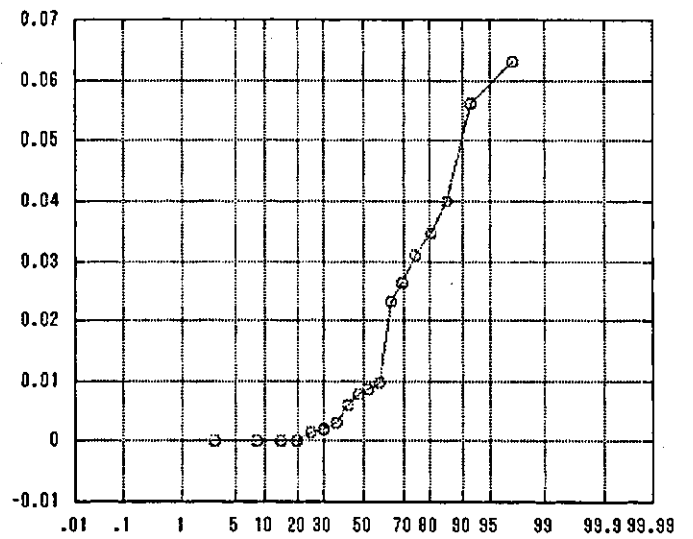
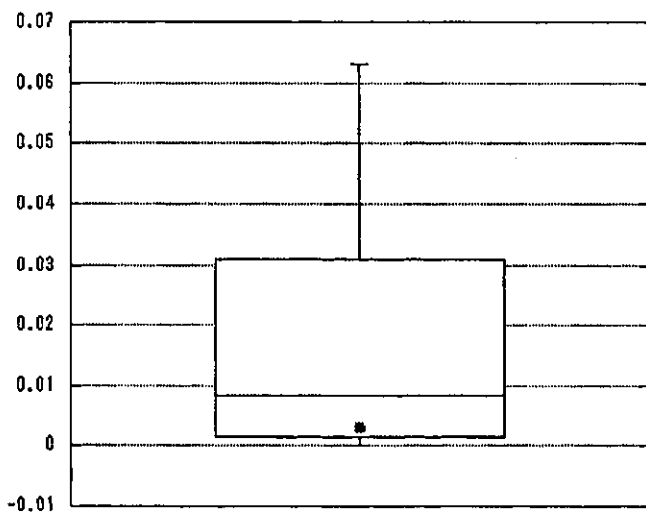

肺炎感染率（感性）

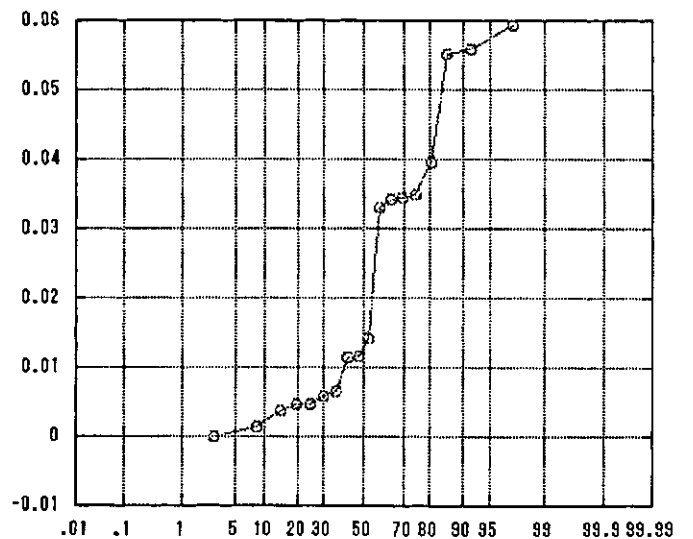
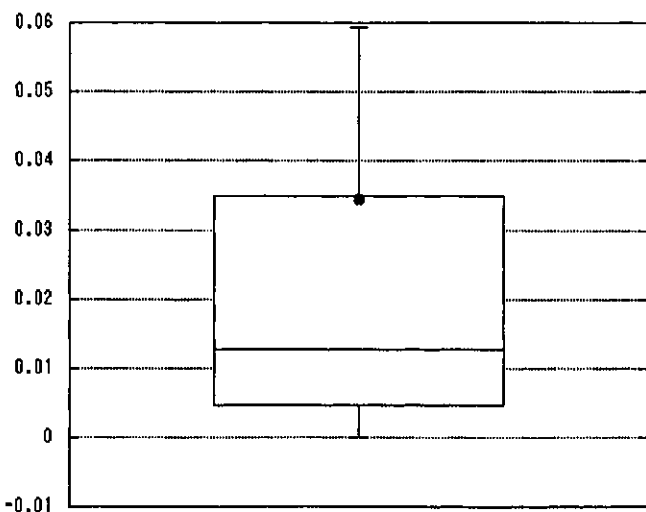

● 自施設



カテ感染率（耐性）

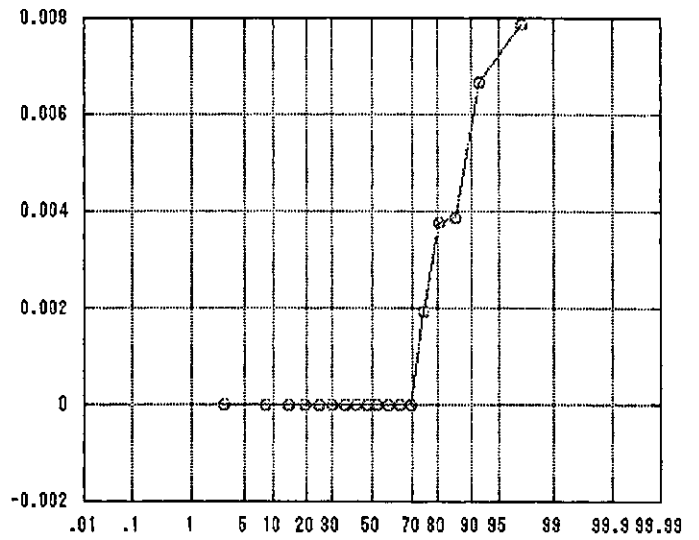
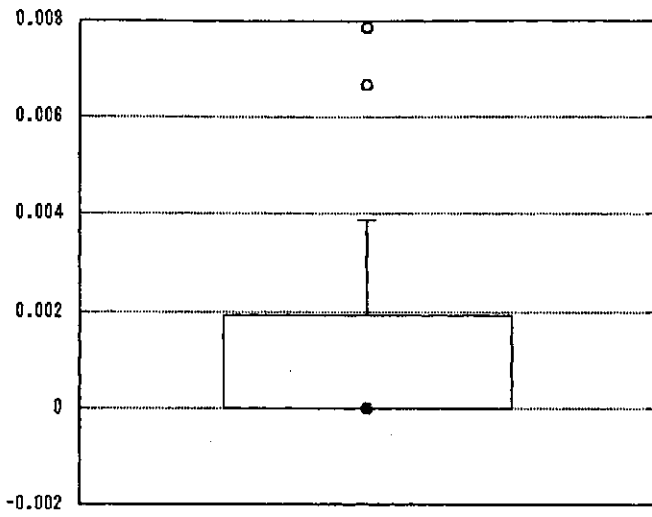

カテ感染率（感性）

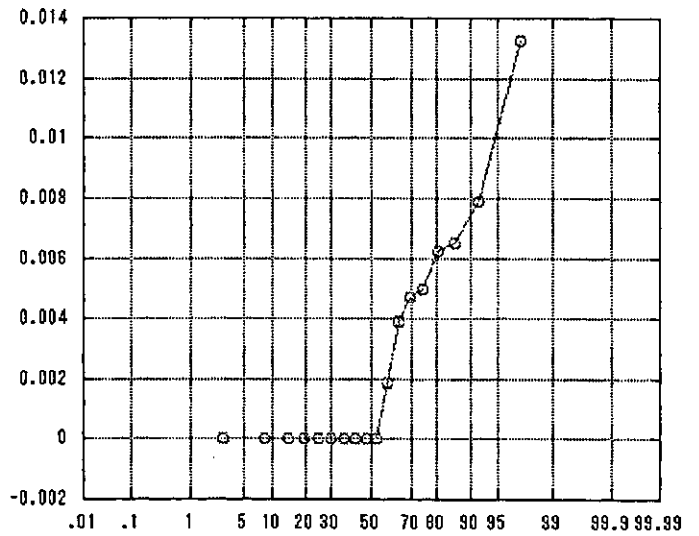
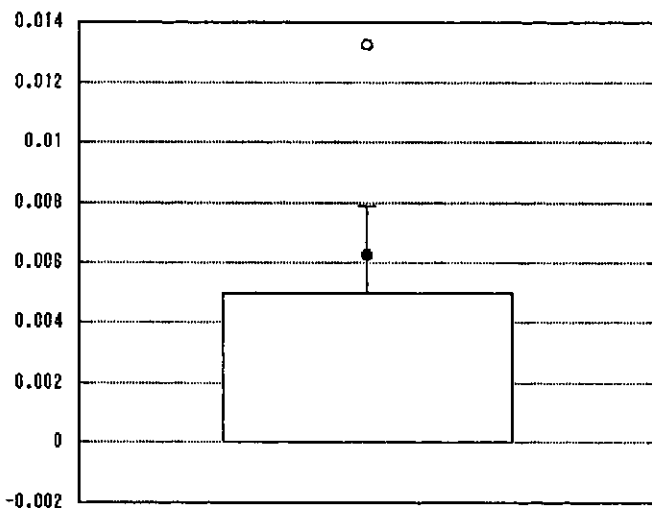

創感染率（耐性）

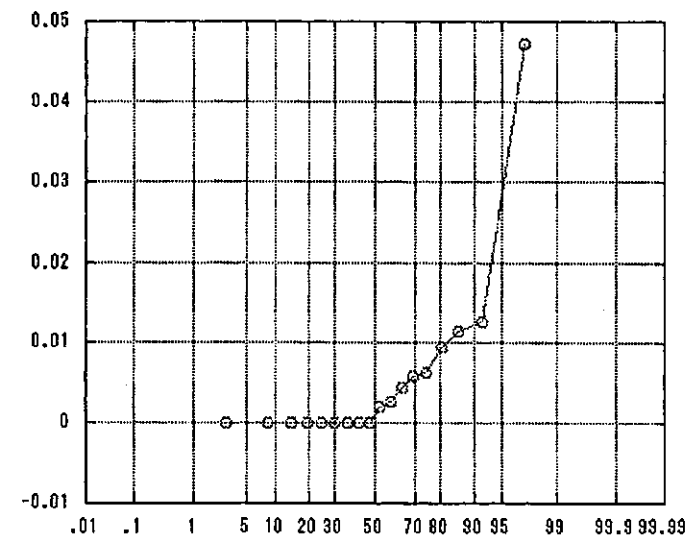
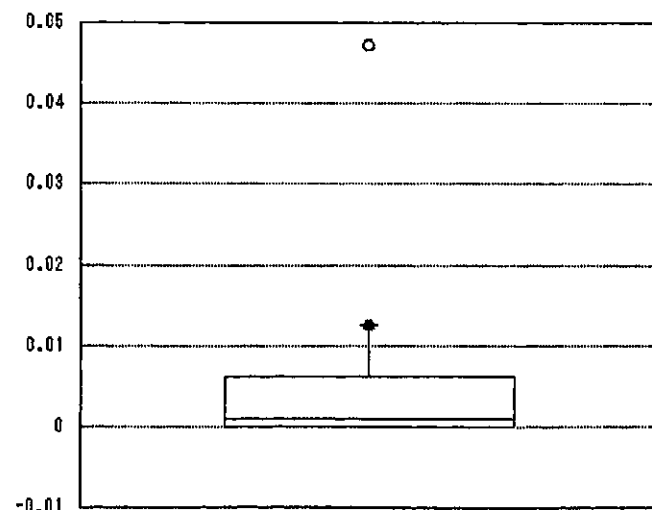

● 自施設

創感染率（感性）

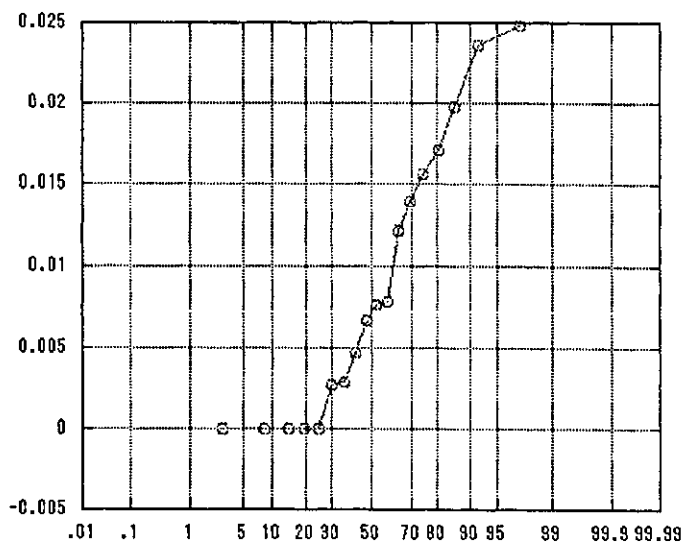
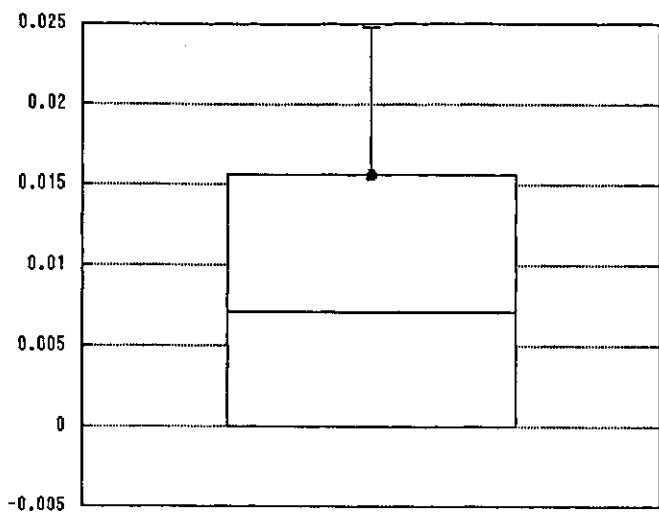

敗血症感染率（耐性）

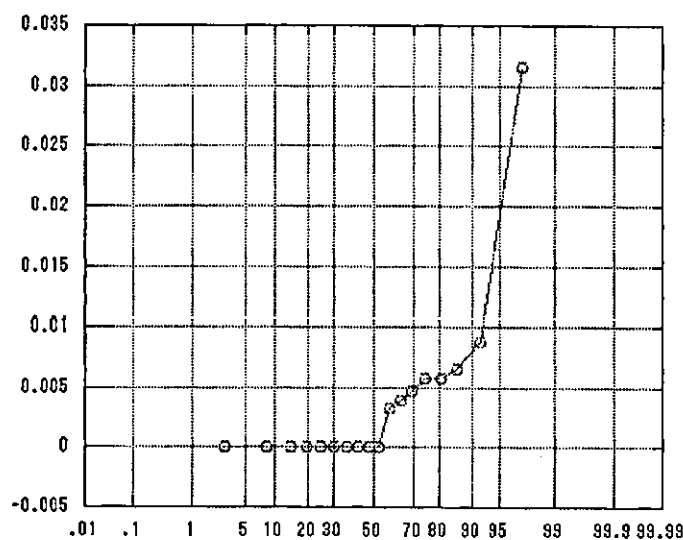
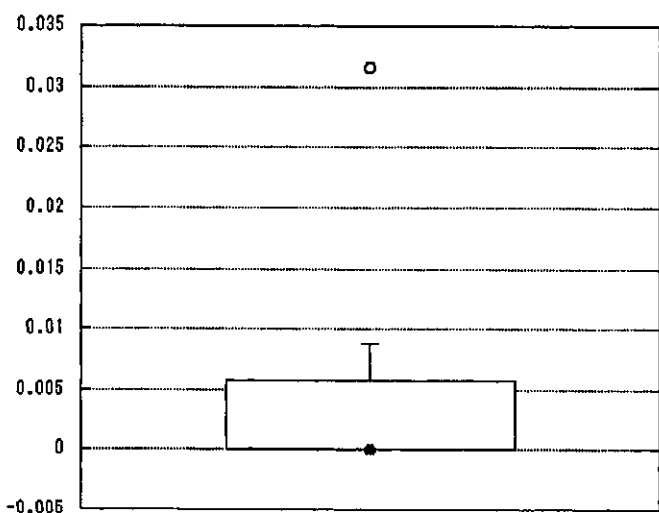

敗血症感染率（感性）

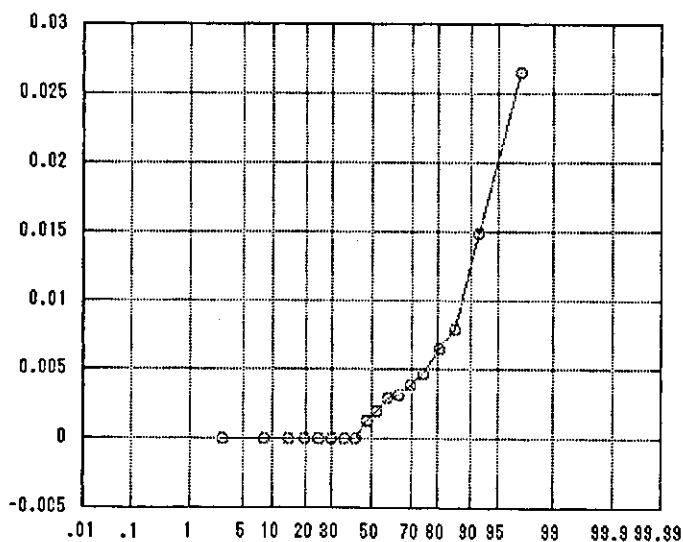
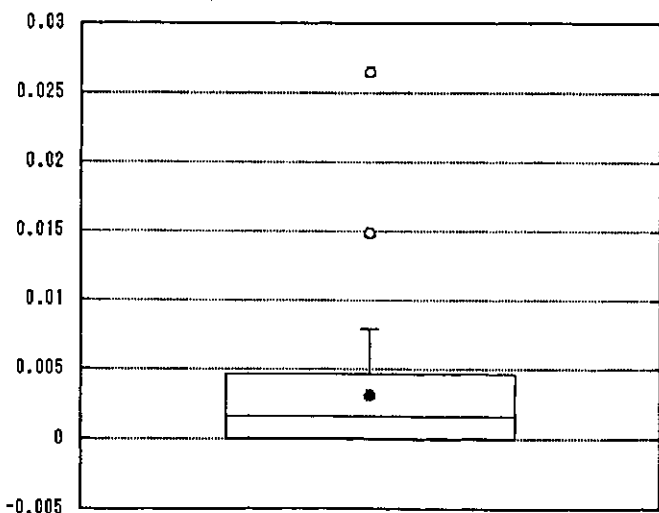

● 自施設

パーセント

尿路感染率（耐性）

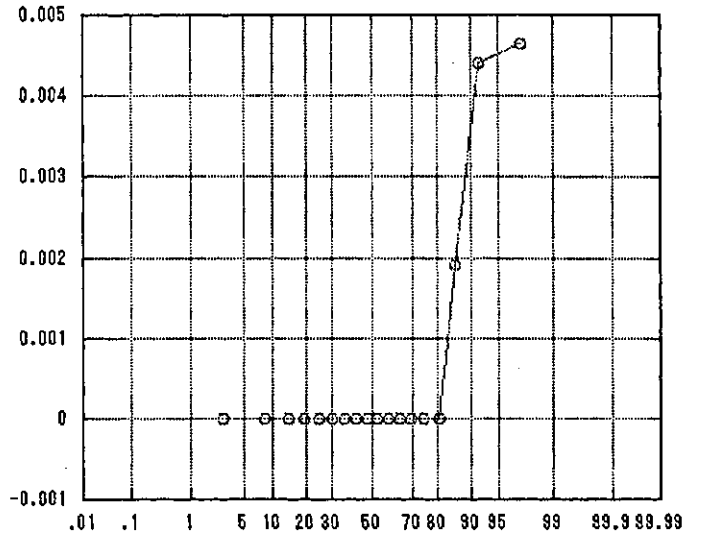
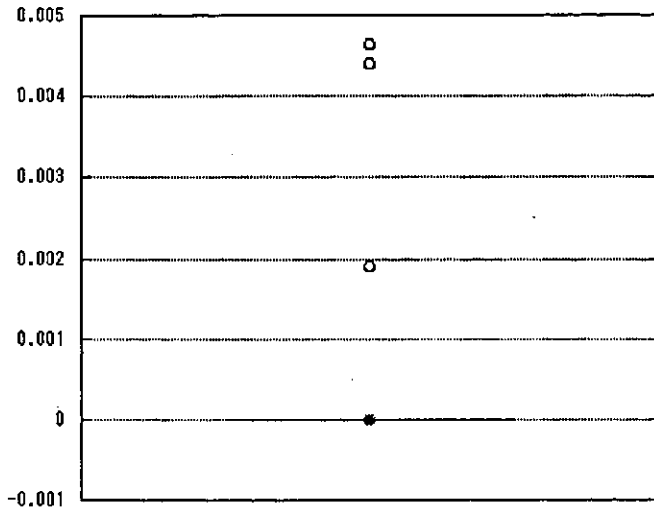

尿路感染率（感性）

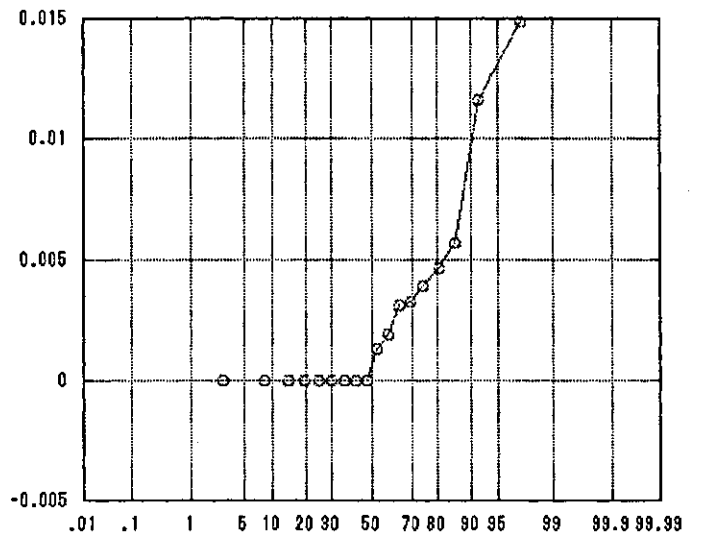
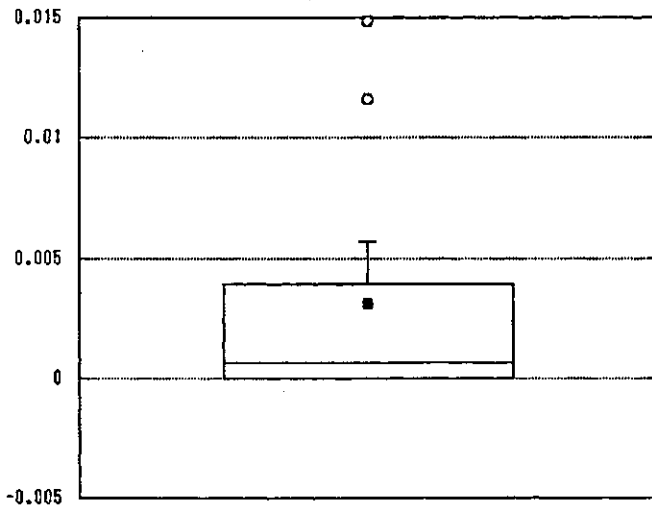

その他感染率（耐性）

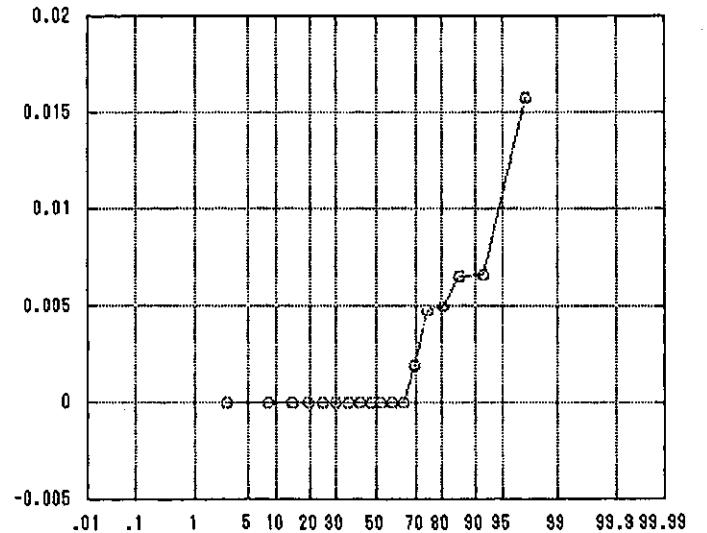
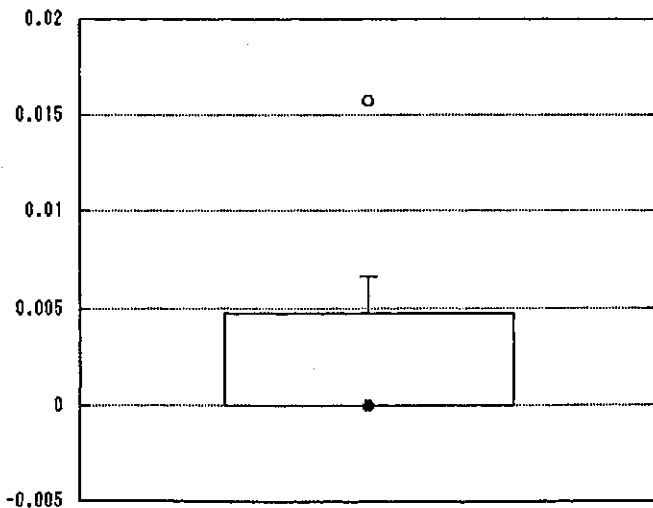

● 自施設

その他感染率（感性）

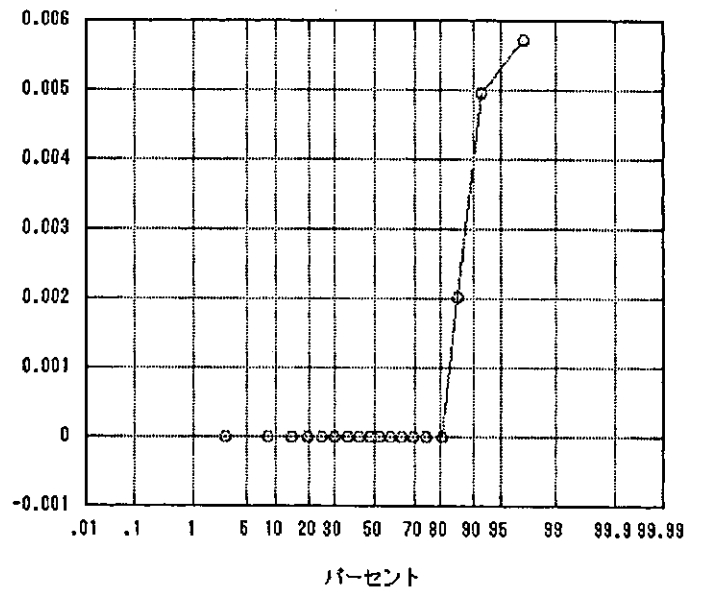
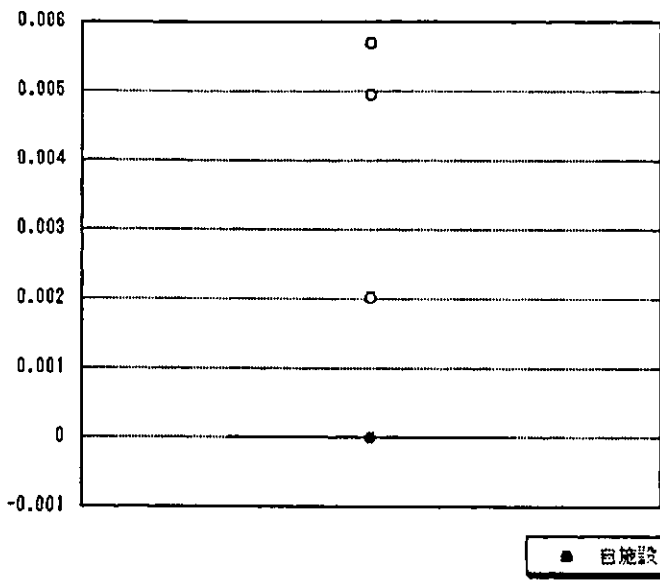

年間収容患者数

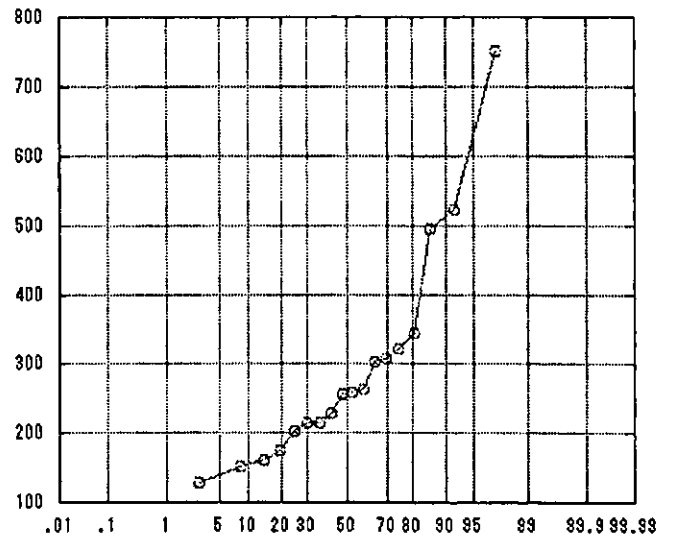
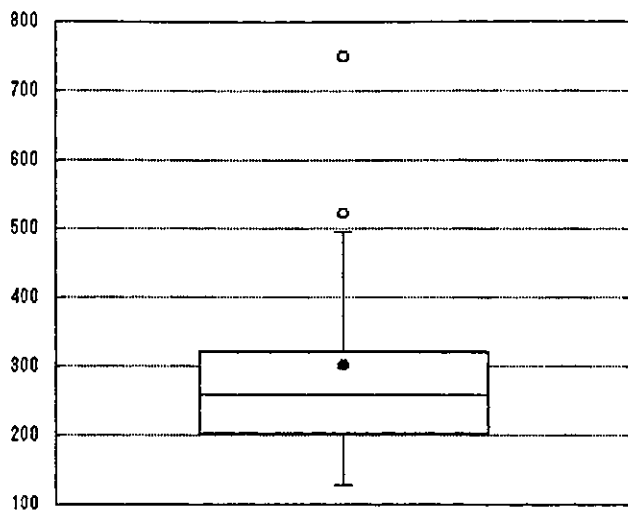

APACHE 0~4

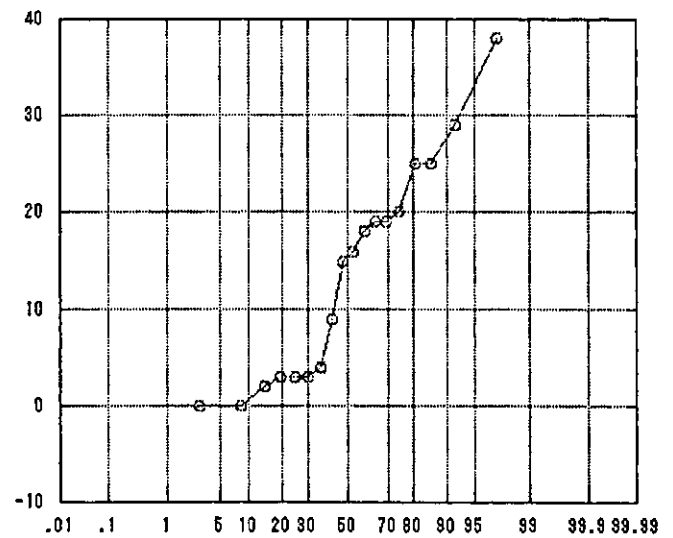
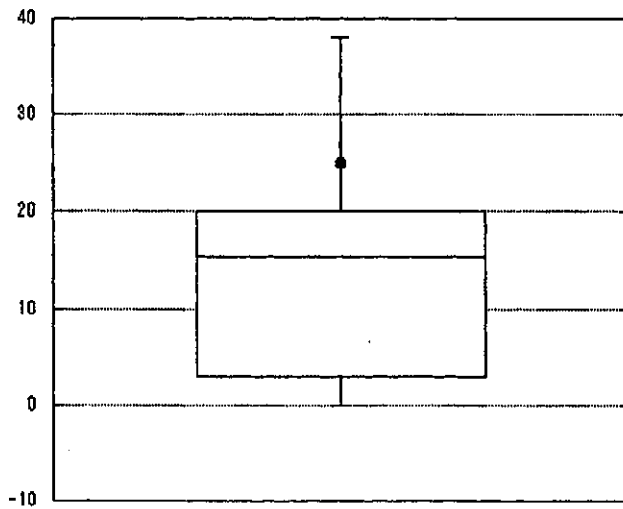

APACHE 5~9

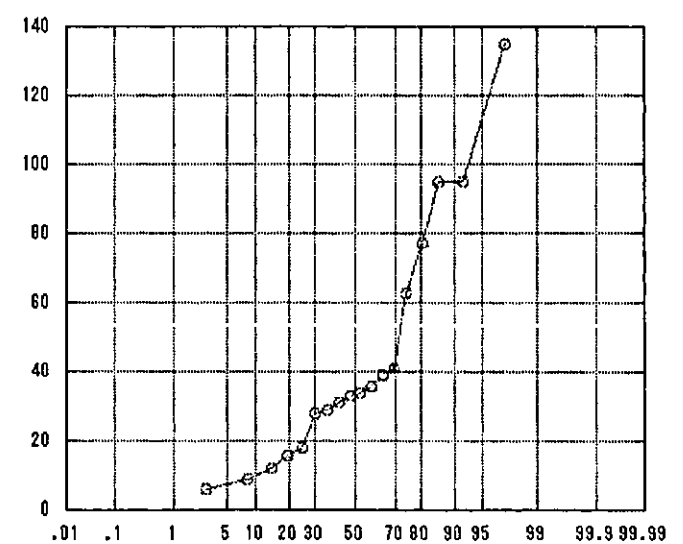
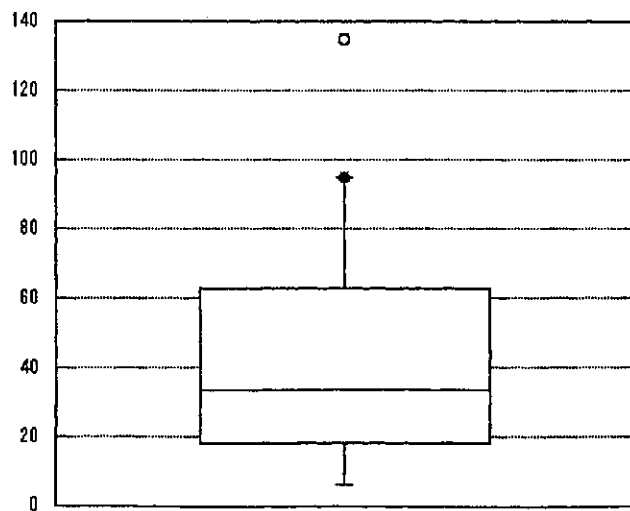

● 自施設

パーセント

APACHE 10~14

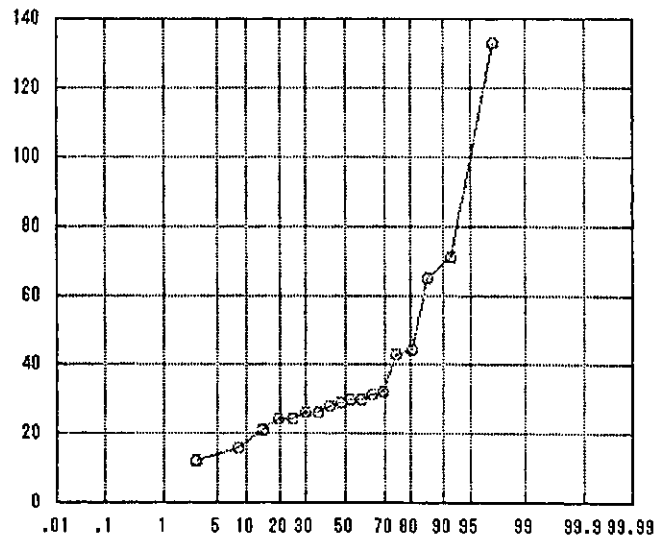
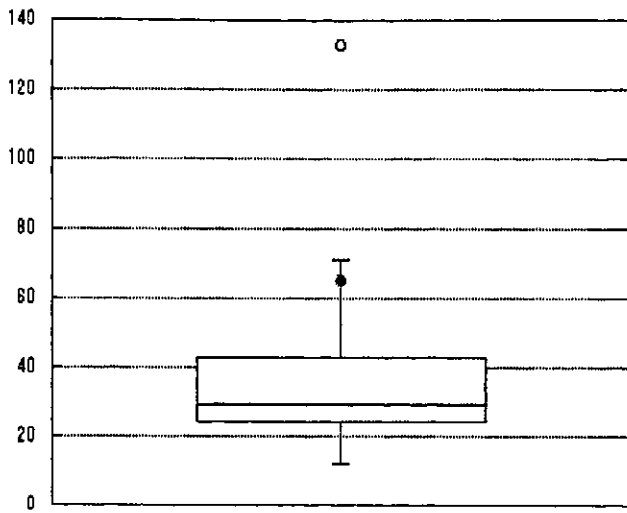

APACHE 15~19

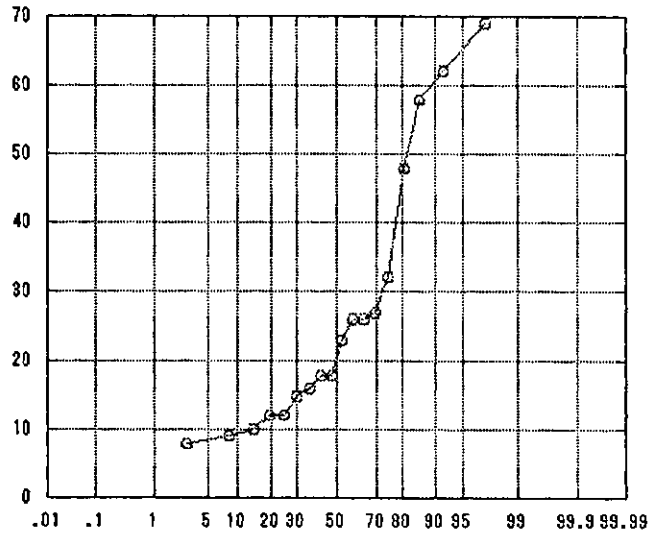
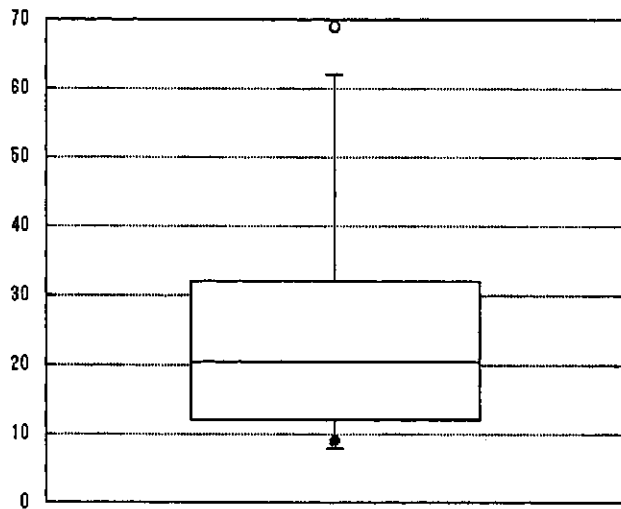

APACHE 20~24

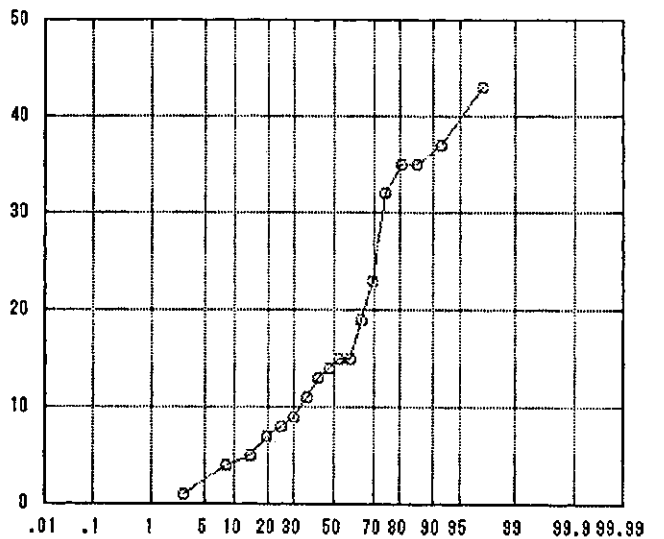
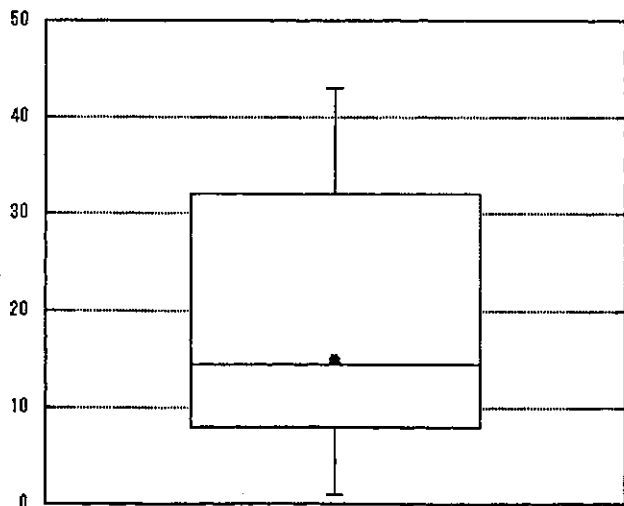

● 自施設

APACHE 25~29

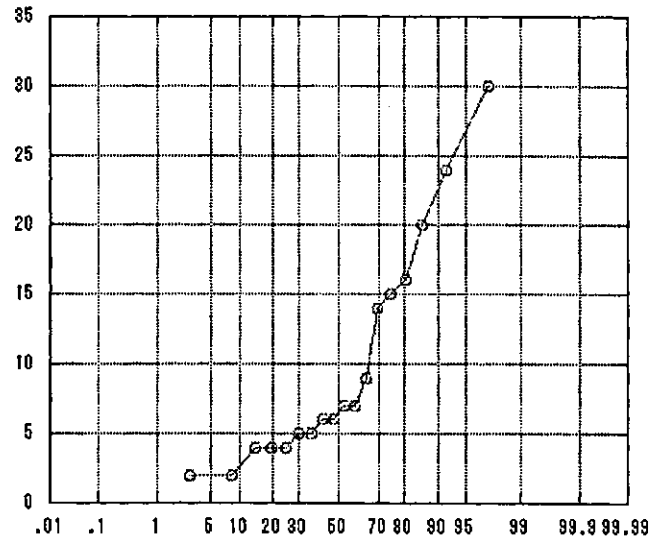
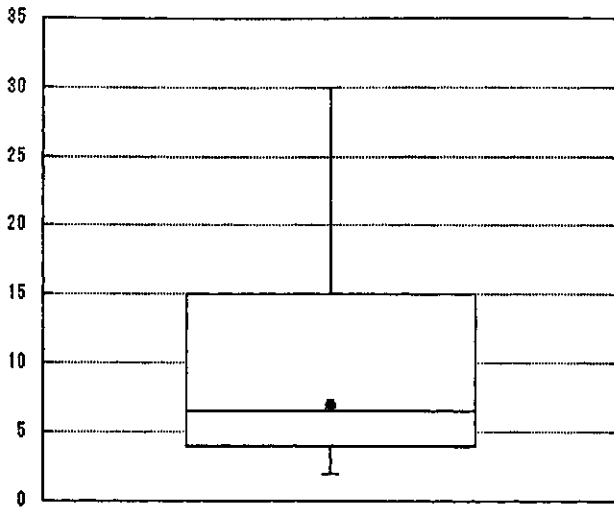

APACHE 30~34

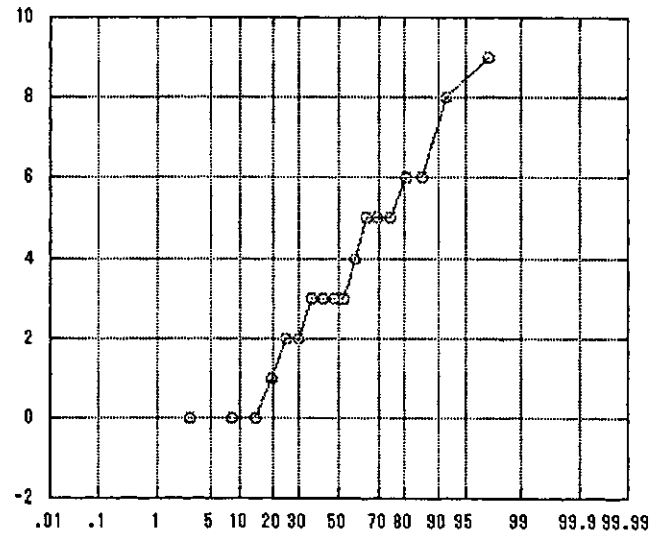
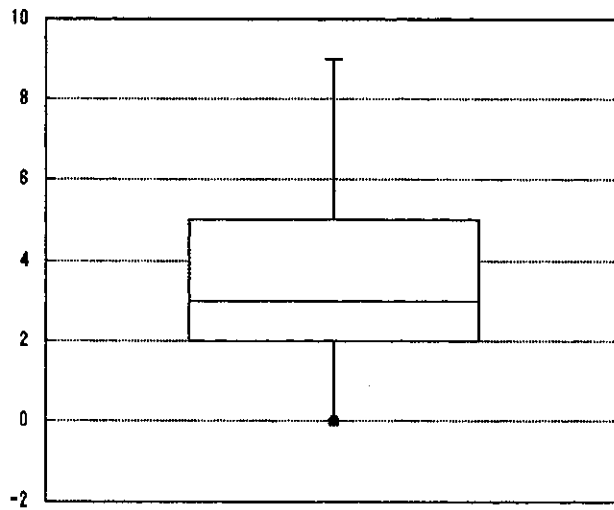

APACHE 35~

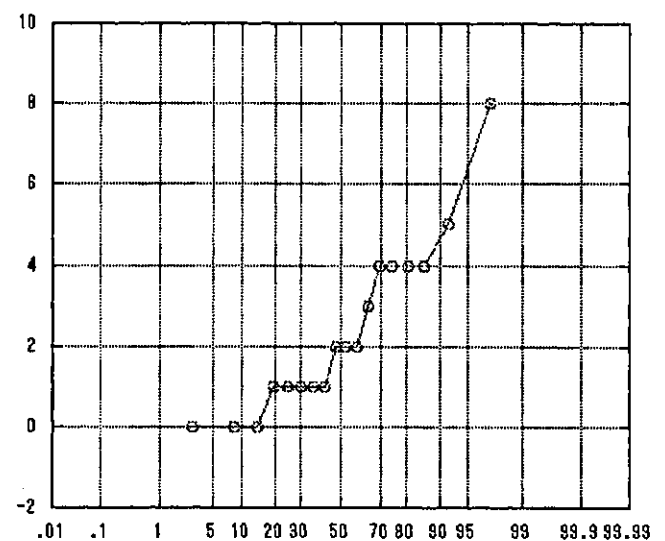
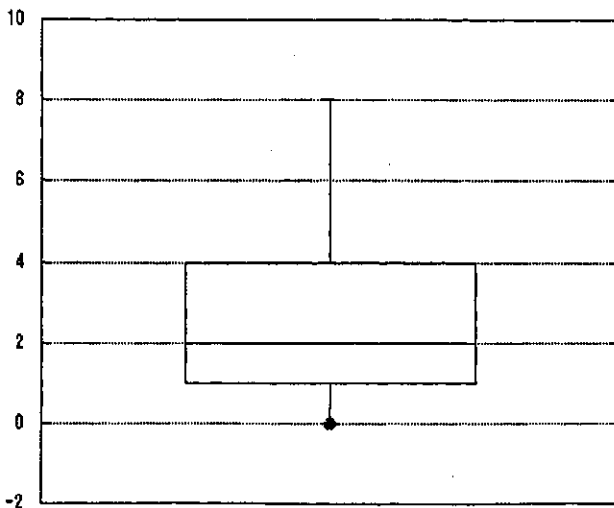

● 自施設

APACHE平均

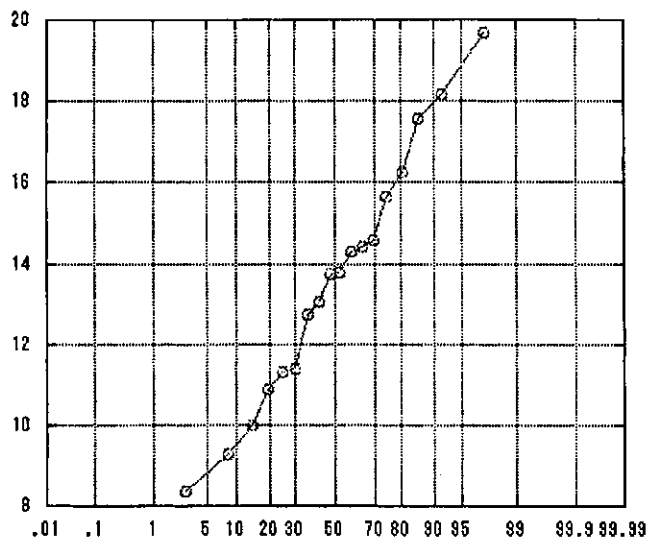
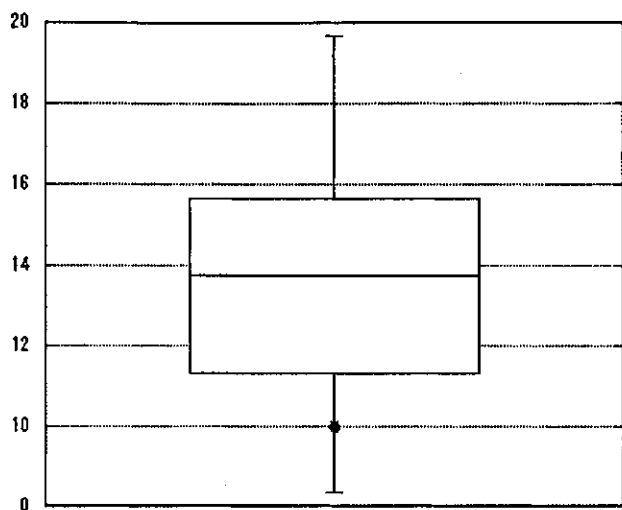

標準化死亡比

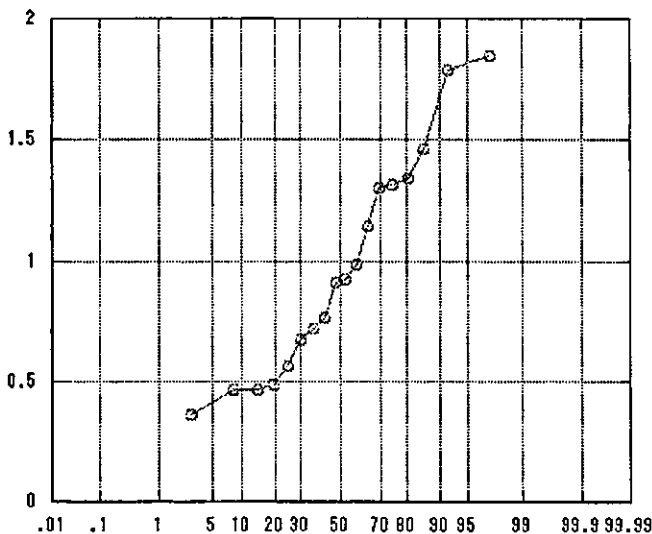
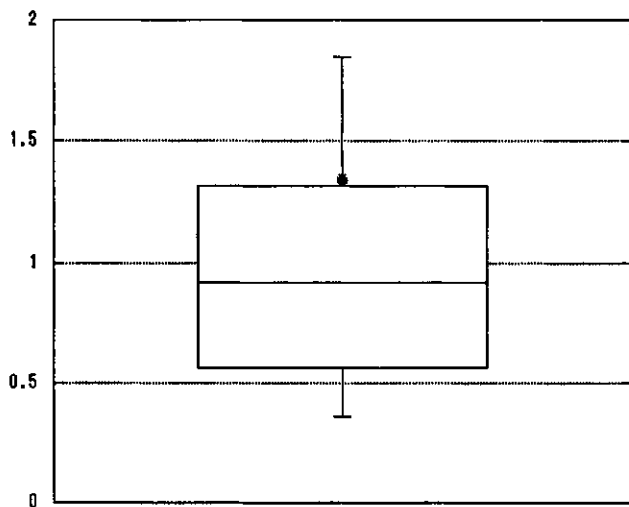

平均在室日数

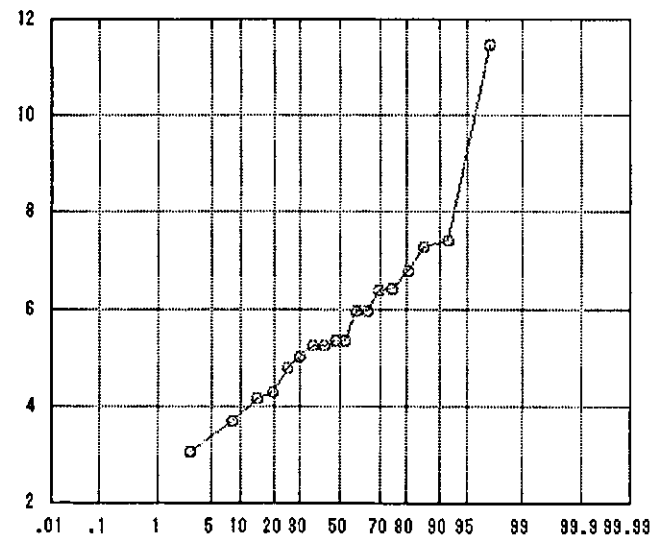
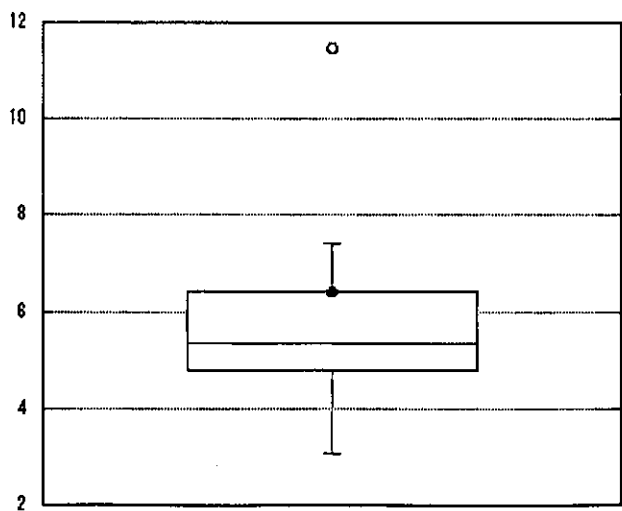

● 自施設



平均在院日数

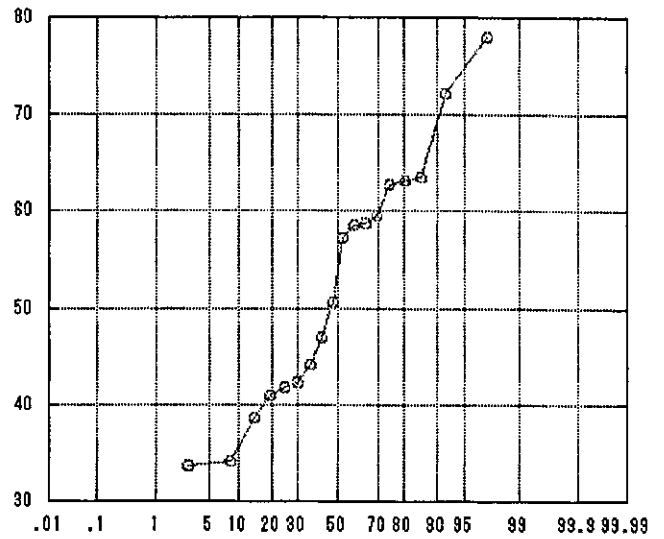
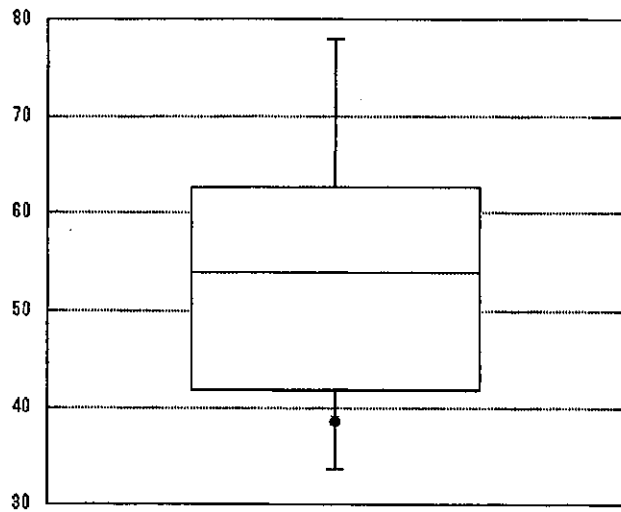

人工呼吸器利用率

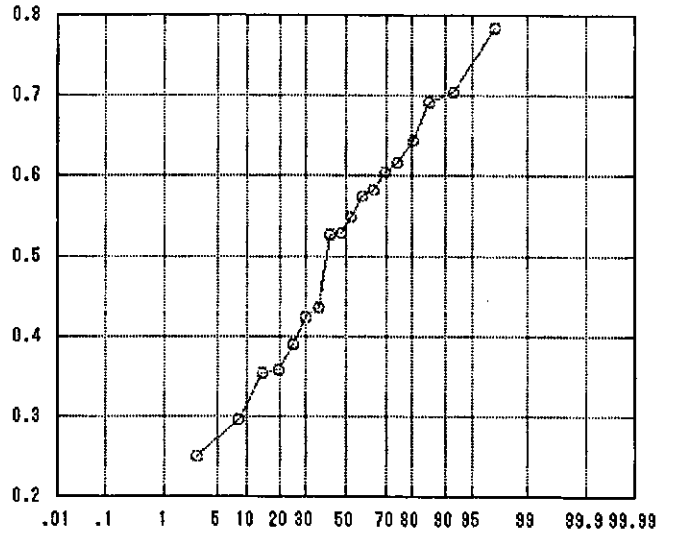
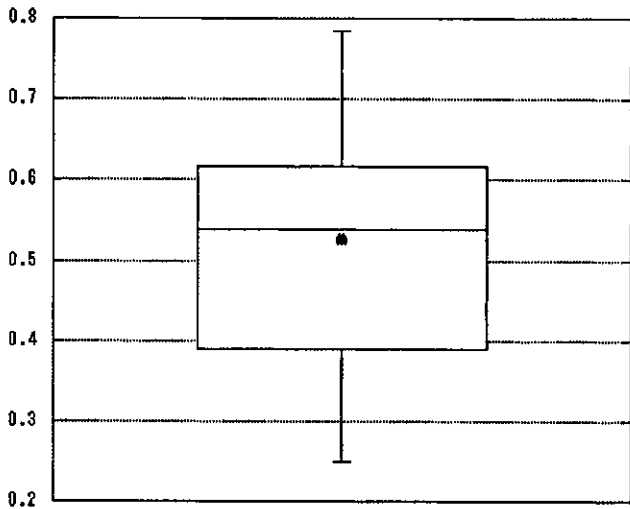

中心静脈カテ利用率

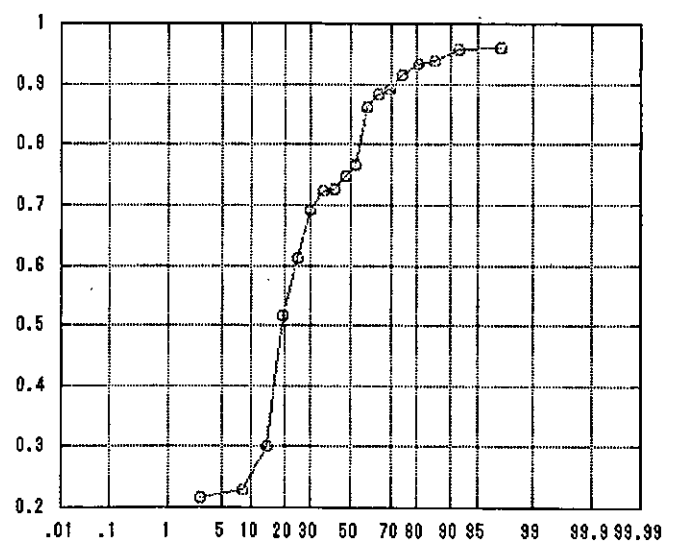
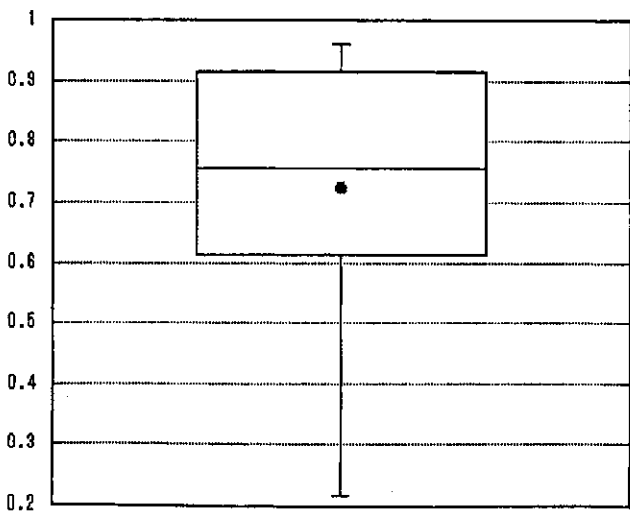

● 自施設

尿道カテ利用率

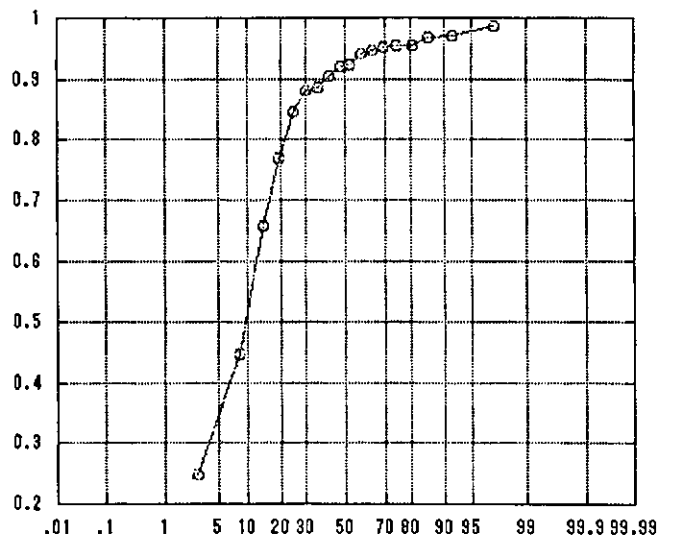
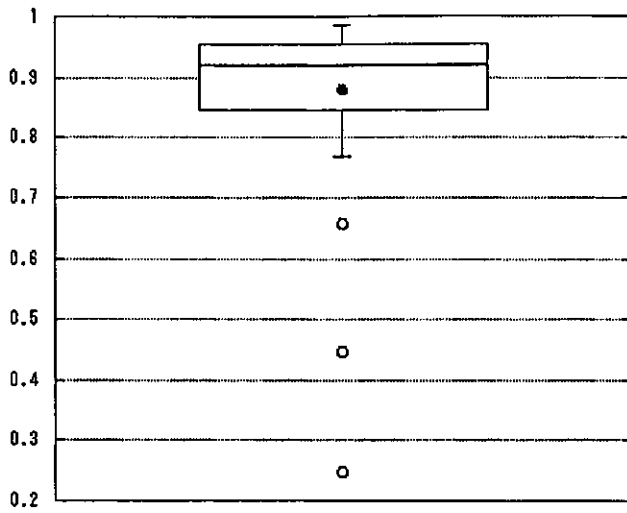

人工呼吸日／患者数

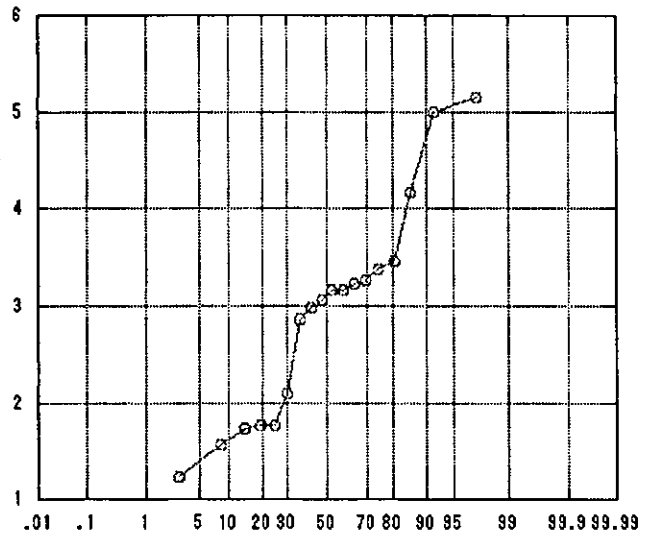
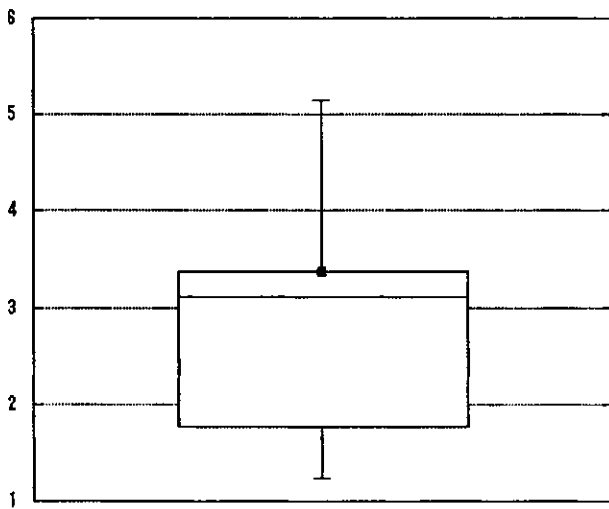

リスク調整感染率（肺炎）

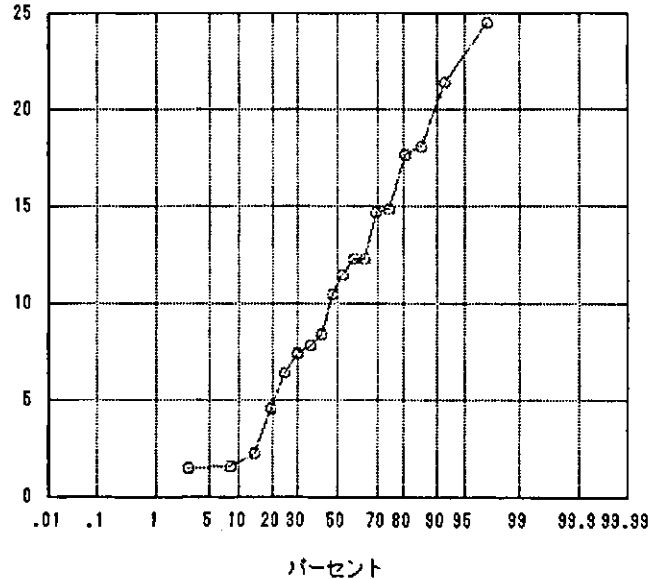
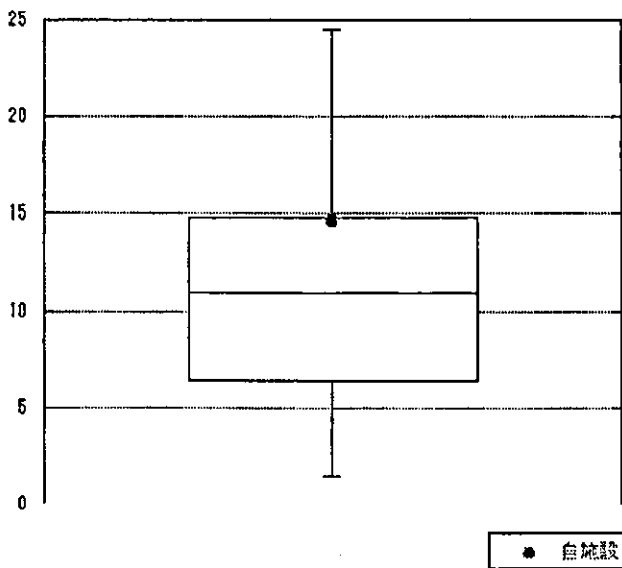

● 自施設

リスク調整感染率（カテ）

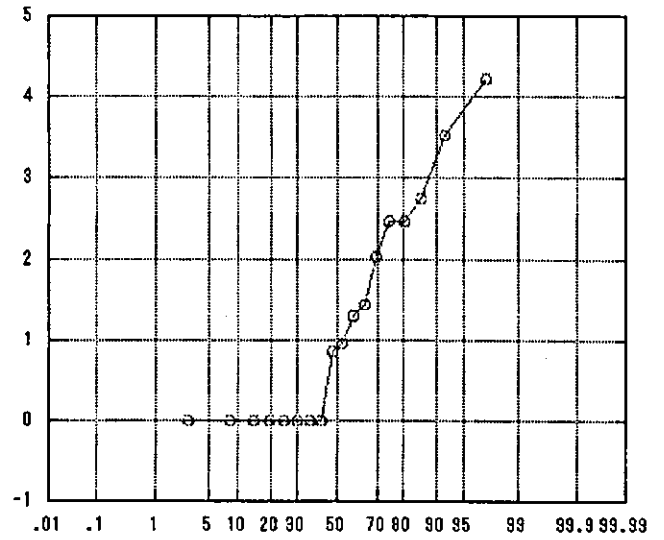
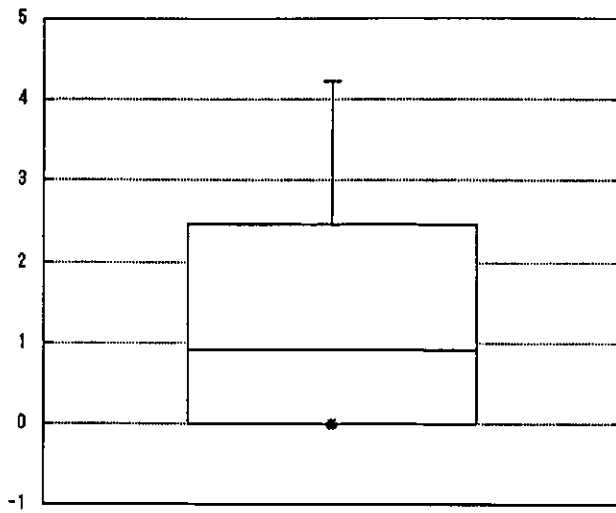

リスク調整感染率（尿路）

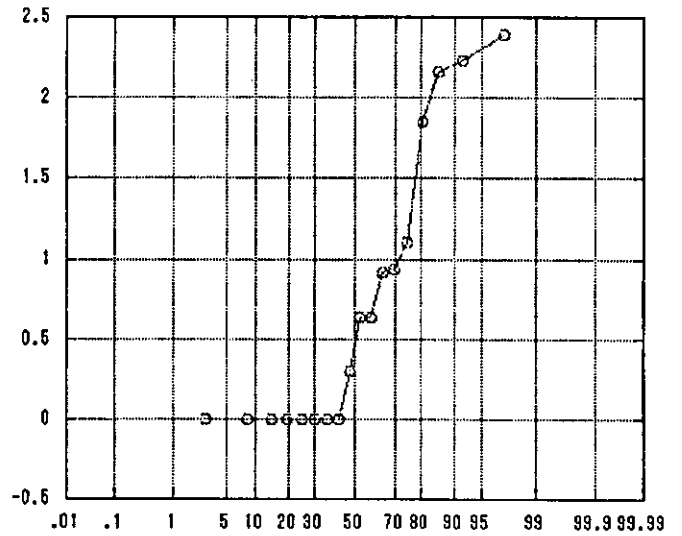
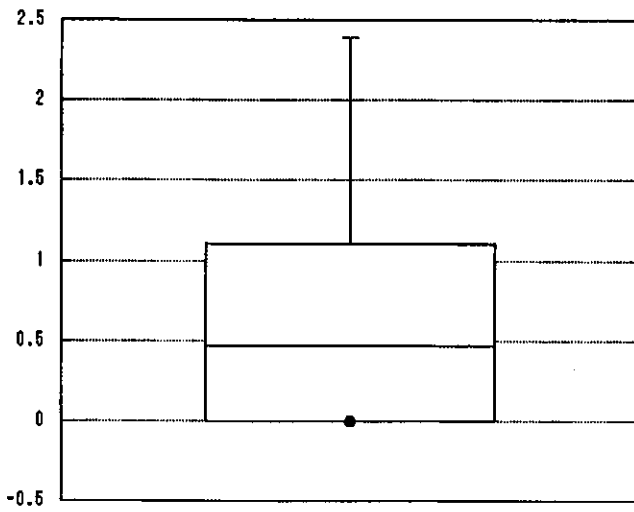

全感染率（耐性）

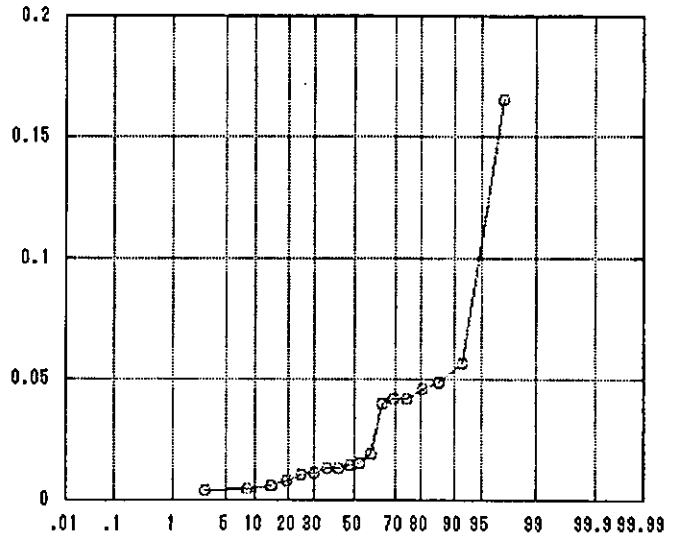
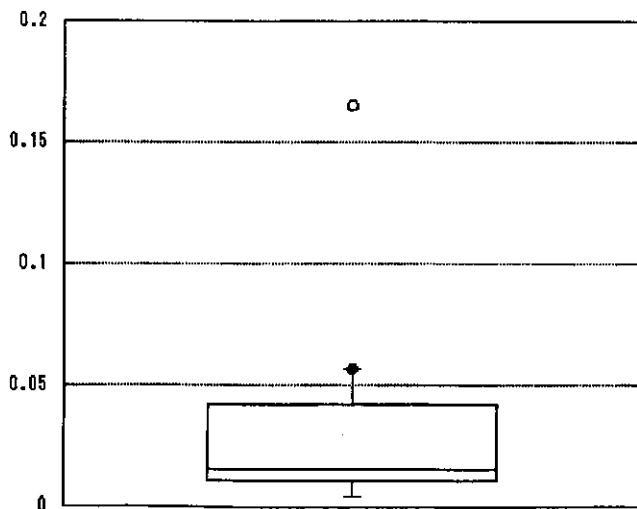

● 自施設

パーセント

全感染率（感性）

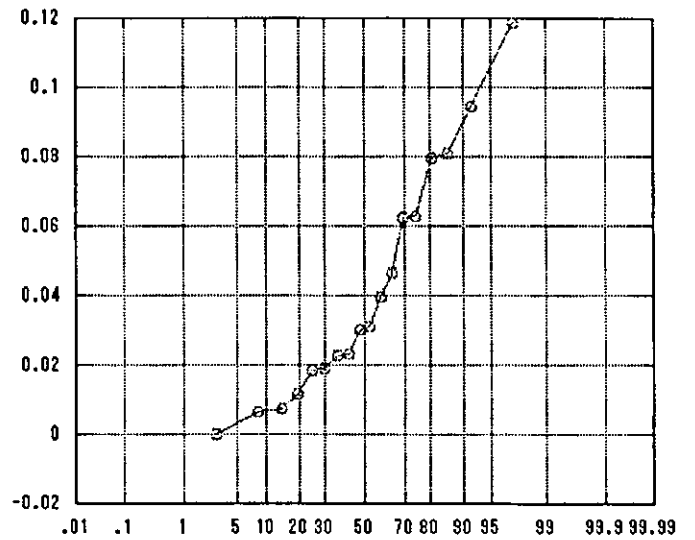
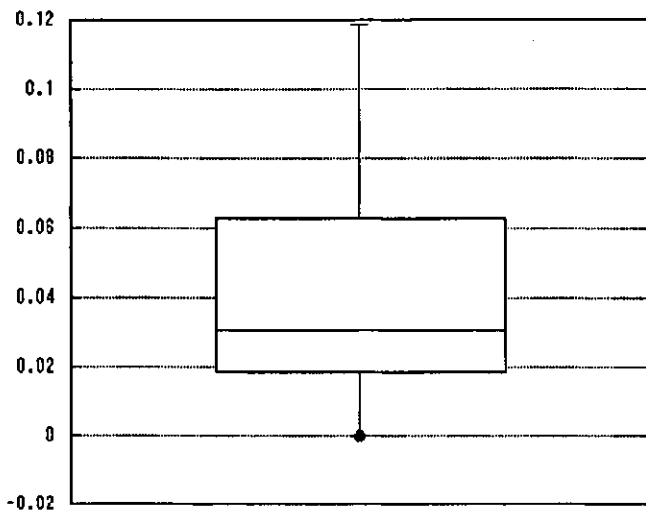

肺炎感染率（耐性）

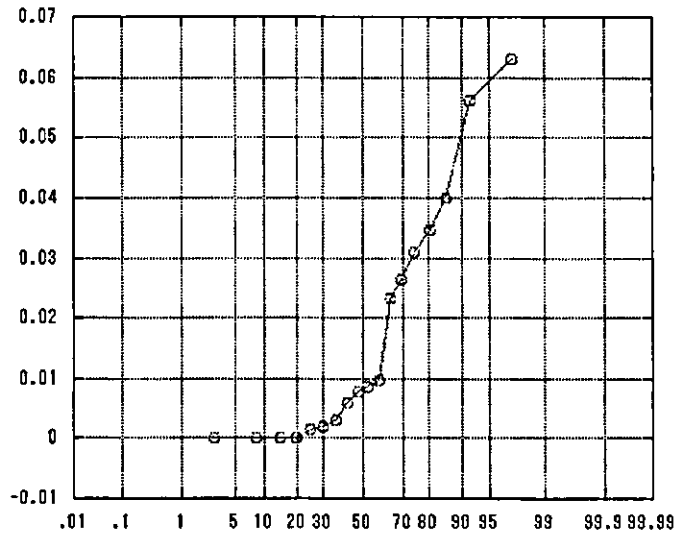
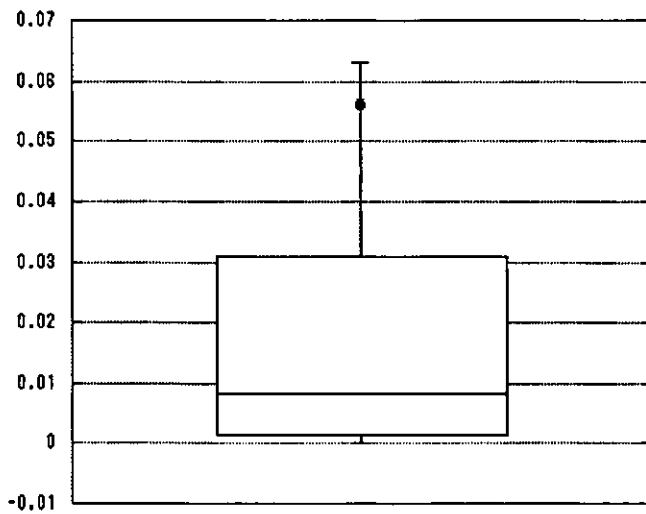

肺炎感染率（感性）

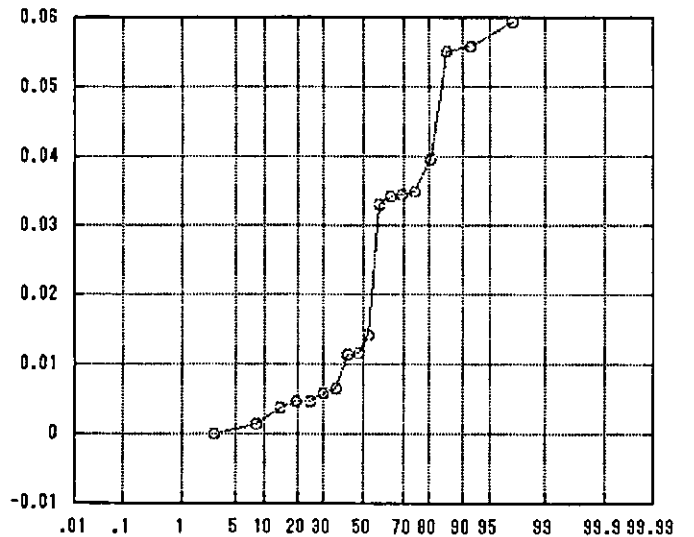
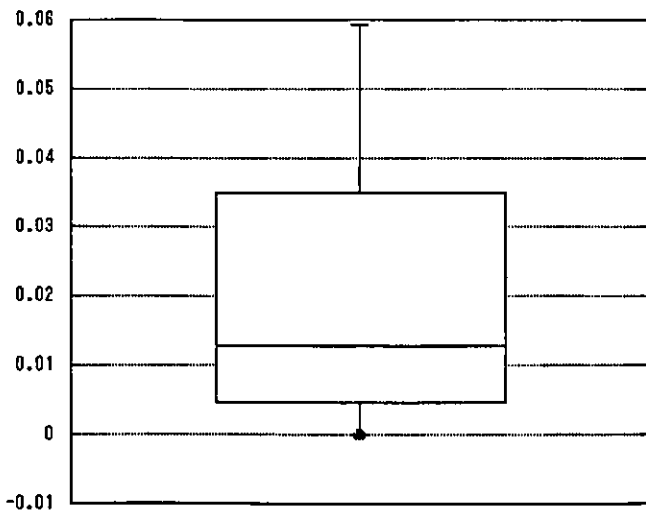

● 自施設