

Figure 1. Pedigree of the family.

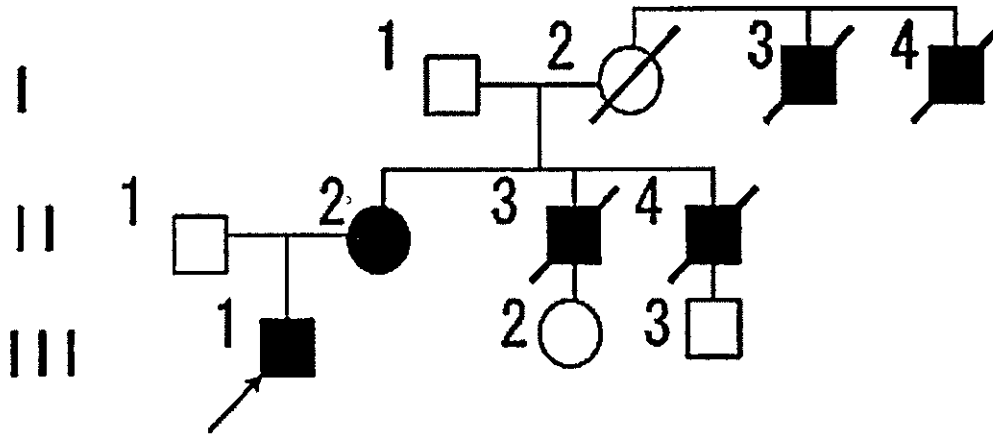

Figure 2. PCR-RFLP analysis of an A9016G mutation

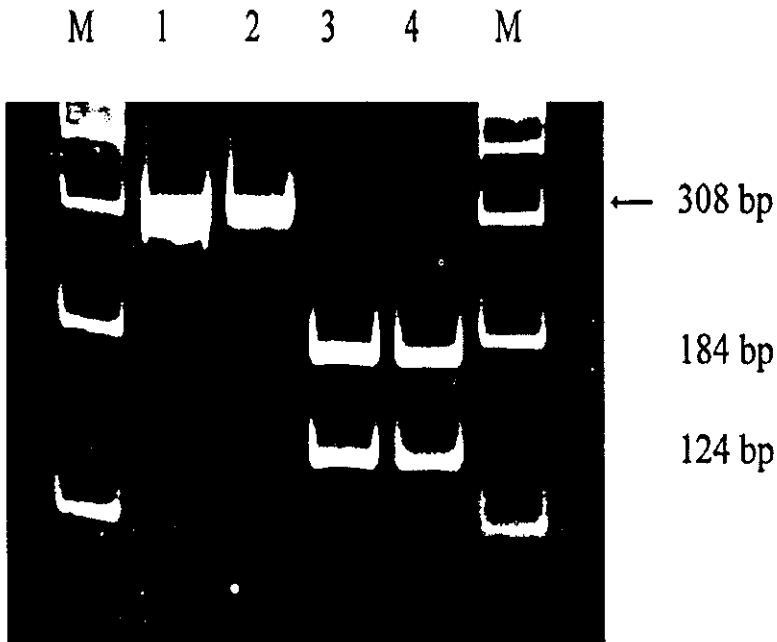

Figure 3. ATPase 6 polypeptide through evolution

 160..... ↓ 170..... 180..... 190
<i>Patients</i>	I Q P M A L A V R L T A N Y T A G H L L M H L I G S A T L A M S T I N L P S T L
<i>Homo sapiens</i>	I Q P M A L A V R L T A N I T A G H L L M H L I G S A T L A M S T I N L P S T L
<i>Bos taurus</i>	I Q P M A L A V R L T A N I T A G H L L I H L I G G A T L A L M S I S T T T A L
<i>Canis familiaris</i>	I Q P M A L A V R L T A N I T A G H L L I H L I G G A T L A L I N I S A T T A F
<i>Gorilla gorilla</i>	I Q P M A L A V R L T A N I T A G H L L M H L I G S A T L A M S T T N L P S T L
<i>Mus musculus</i>	I Q P M A L A V R L T A N I T A G H L L M H L I G G A T L V L M N I S P P T A T
<i>Sus scrofa</i>	I Q P V A L A V R L T A N I T A G H L L I H L I G G A T L A L L N I N T M T A F

Figure legends

Figure 1.

Pedigree of the family. *Arrow* shows the Proband (III.1), and filled symbols show affected members for LHON (subjects I.3, I.4, II.2, II.3, and II.4). Five persons out of 5 men in the maternal relatives in this family are LHON indicated 100% penetrance in men.

Figure 2.

HpyCH4 IV restriction endonuclease digestion pattern for the A9016G shows in the 12% PAGE. The full length of PCR product (308bp) was cut into two fragments in the presence of the A9016G. Both patients showed heteroplasmic condition in the 93 %of mutant. Lane designations: 1 = undigested PCR product, 2 = control after digestion, 3 = PCR from mother after digestion, 4 = PCR from proband after digestion.

Figure 3.

Comparison of mitochondrial ATPase 6 polypeptide among different species through evolution. The A9016G changes a conserved amino acid from isoleucine into valine at the aminoacid number of 164.

A NOVEL MYC-TARGET GENE, *MIMITIN*, THAT IS INVOLVED IN CELL PROLIFERATION OF ESOPHAGEAL SQUAMOUS CELL CARCINOMA

Makoto Tsuneoka¹, Kwesi Teye¹, Nobuyuki Arima², Mikiko Soejima¹, Hidenori Otera³, Kazuyo Ohashi⁴, Yasutoshi Koga⁵, Hiromasa Fujita⁶, Kazuo Shirouzu⁶, Hiroshi Kimura⁷, and Yoshiro Koda¹

¹Division of Human Genetics, Department of Forensic Medicine, ²Department of Pathology, ³Department of Pediatrics and Child Health, ⁴Department of Surgery, Kurume University School of Medicine, Kurume, ⁵Department of Molecular Biology, Graduate School of Medical Science, Kyushu University, Fukuoka, ⁶Graduate School of Science and Technology, Chiba University, Chiba, ⁷Chiba Institute of Science, Choshi, Chiba, Japan

Running Title: A novel Myc target gene *mimitin*

Address correspondence to: Makoto Tsuneoka, Division of Human Genetics, Department of Forensic Science, Kurume University School of Medicine, Kurume 830-0011, Japan, Tel. +81-942-31-7554; Fax. +81-942-31-7700; E-mail: tsuneoka@med.kurume-u.ac.jp.

Myc is a ubiquitous mediator of cell proliferation that transactivates the expression of various genes through E-box sites. Here we report a novel gene, *mimitin* (Myc-induced mitochondrial protein), that encodes a mitochondrial protein with a MW of 20 kd. We demonstrated that the transcription of *mimitin* is directly stimulated by c-Myc. To investigate the role of Mimitin, its expression was suppressed by the RNA interference (RNAi) technique. While specific inhibition of *mimitin* expression did not affect cell proliferation in human cervical carcinoma, colon adenocarcinoma, and hepatocarcinoma cell lines, it did suppress cell proliferation in human glioblastoma, esophageal squamous cell carcinoma (ESCC), and embryonic lung fibroblastic cells, with the greatest suppression efficiency in ESCC cells. To investigate whether *mimitin* is related to tumorigenesis in ESCC *in vivo*, the expression of Mimitin protein in ESCC tissues was studied. Mimitin was highly expressed in 80% (28 out of 35) of ESCC tumors, suggesting that high expression of Mimitin is a characteristic feature of ESCC. The expression level of Mimitin was found to be correlated with that of c-Myc and cell proliferation, but not with the histopathological grade, stage of cancer, or age of patients. Taken together, these results suggest that the novel gene *mimitin* is a direct transcriptional target of c-Myc, and is involved in Myc-dependent cell proliferation at least in ESCC cells.

INTRODUCTION

The *myc* family of proto-oncogenes consists of three main genes: *c-myc*, *N-myc*, and *L-myc* (1-5).

Deregulated expression of *myc* family genes through gene amplification, viral promoter insertion, chromosomal translocation, or promoter mutation has long been known to be associated with neoplastic diseases in a wide range of vertebrates including humans. Embryonic mice with *c-myc* or *N-myc* deleted develop multi-organ hypoplasia and die during mid-embryogenesis (6-8). These results indicate that the *myc* family genes are central regulators of cell growth (4, 5, 9).

c-myc is one of the most widely studied proto-oncogenes, and it is the best characterized member of the *myc* gene family. In general, *c-myc* expression is associated with cell proliferation and is down-regulated in quiescent and differentiated cells. The protein encoded by *c-myc* is a member of the basic helix-loop-helix leucine zipper transcription factors (5, 9). c-Myc protein has been shown to directly transactivate the expression of a number of genes (10), including *ornithine decarboxylase (ODC)* (11), *RCC1* (12), *nucleolin* (13), *cyclin D2* (14), and *mina53* (15), through E-box sites (CACGTG elements) on their genomic DNA. However, *c-myc* remains enigmatic, and information about additional genes controlled by *c-myc* may help elucidate its function.

Esophageal squamous cell carcinoma (ESCC) is a highly aggressive disease with a poor prognosis (16). It was suggested that genetic changes associated with the development of ESCC involve activation of proto-oncogenes (17), including cyclin D1 (18), *c-erbB2*, and *c-myc*, and inactivation of several tumor suppressor genes, including p53, Rb, and p16 (19-22). However, the precise mechanisms of the development of ESCC remain unclear.

Here we report a novel gene, *mimitin*, whose expression is directly induced by c-Myc. The *mimitin* gene encodes a protein with a MW of 20 kd, which localizes in mitochondria. Our results suggest that *mimitin* contributes to cell proliferation in ESCC cells.

EXPERIMENTAL PROCEDURES

Cells and cell culture - The human cells, cervical carcinoma HeLa, promyelocytic leukemia HL60, colon adenocarcinoma SW620, glioblastoma T98G, T98G-expressing c-MycER chimeric protein (T98Gmycer-2 cells) (15), ESCC TE-11 (23, 24), hepatocellular carcinoma Kyn2 (25), and embryonic lung HEL (26) were described previously. T98G cells were cultured in Eagle's minimum essential medium supplemented with non-essential amino acids and 10% fetal calf serum (FCS). The other cells were cultured in Dulbecco's modified Eagle's medium containing 10% FCS.

Polymerase chain reaction (PCR), rapid amplification of 5' cDNA ends (5'-RACE) and 3' cDNA ends (3'-RACE) - PCR amplifications were performed using Ex Taq polymerase (Takara, Shiga, Japan) or KOD polymerase (Toyobo, Osaka, Japan) according to their manufacturer's instructions. 5'-RACE reactions were performed as described previously (15, 27). The first PCR for 5'-RACE was performed using the primer, *mimitin*-RACE-1 (5'-GCTGCTGGGAGCCACTGAGGGTTCT-3', a sequence in the EST clone AI803230) and the AP1 primer provided by the supplier. Nested PCR was performed using the *mimitin*-RACE-2 primer (5'-GCATGGCCTTTAATTTGAGTTTGAAC-3'), which corresponds to a sequence in the upstream region of *mimitin*-RACE-1, and the AP2 primer provided by the supplier. The amplified 0.5 kb fragment was cloned into a pGEM-T vector (Promega, Madison, WI) and sequenced.

The 3'-RACE was performed with the same protocol as the 5'-RACE using primers, *mimitin*-3'RACE-1 (5'-GCGGCTGGAGCATTACCCCTACTGC-3', a sequence that was found in the 5'-RACE product) for the first PCR, and *mimitin*-3'RACE-2 primer (5'-AAACTGGGTGGACGGCATGGGTTGG-3'), which corresponds to a sequence in the

downstream region of *mimitin*-3'RACE-1 for nested PCR. The amplified 0.6 kb fragment was cloned into a pGEM-T vector (Promega) to produce pT/*mimitin*, and sequenced. It was found that pT/*mimitin* contains a DNA sequence encoding the whole 169 amino acid protein.

Plasmids - cDNA for human *mimitin* was amplified by PCR with 5'-CCGGAATTCTGCCATGGGTTGGTCTCAGGATTTGTTCC-3' (5'-*mimitin*Eco), adding an *Eco*RI site just before the initiation methionine, and 5'-GGAAGATCTGAATTCATTGATTGTGGCTCTGCCATCTCG-3', adding an *Eco*RI site just after the stop codon, as primers from pT/*mimitin*. The 0.5 kb fragment was cleaved with *Eco*RI, and inserted into fragments of a pCAGGS mammalian expression vector (28), an *E. coli* expression vector pGEX-3X (Amersham Biosciences, Piscataway, NJ), and an *E. coli* expression vector pET28b(+) (Novagen, Madison, WI), which were cleaved with *Eco*RI and dephosphorylated with *E. coli* alkaline phosphatase, to produce pCAGGS/*mimitin*, pGEX/*mimitin* for GST-Mimitin fusion protein, and pET28/*mimitin* for His x 6 tagged-Mimitin protein, respectively. cDNA for human *mimitin* was amplified by PCR with 5'-*mimitin*Eco, and 5'-GCATGGTACCTGATTGTGGCTCTGCCATC-3', deleting the stop codon and adding a *Kpn*I site, as primers from pT/*mimitin*. The 0.5 kb fragment was cleaved with *Eco*RI and *Kpn*I, and inserted into a fragment of a pcDNA3.1/myc-His(-)B mammalian expression vector (Invitrogen, Carlsbad, CA) to produce pcDNA/*mimitin*-mychis. Reporter plasmids containing a *mimitin* genomic DNA fragment were constructed as described below. A 0.9 kb genomic DNA fragment of the human *mimitin* gene, which extends from the promoter region to intron 1, was amplified by PCR with 5'-GTGGAGGGCAGTTATTCTTTGGAG-3' and 5'-GGGCTCTCACTTTTCCTTCTTTA-3', and cloned into a pGEM-T vector (Promega) to produce pT/*mimitin*(promoter). The DNA fragment was amplified from pT/*mimitin*(promoter) with 5'-GTGGAGGGCAGTTATTCTTTGGAG-3' and 5'-GGGGCTCCCATGGTTCCTTCTTTACTGACCTC-3', adding a *Nco*I site. The 0.9 kb amplified fragment was cleaved with *Bam*HI and *Nco*I to produce a 0.7 kb fragment, and inserted into the

4.8 kb fragment of a pGL3-Basic vector that contained firefly *luciferase* cDNA (Promega), which was cleaved with *Bgl*II and *Nco*I to produce pmimitin(W)luci. The *mimitin* genomic DNA fragment contains a CACGTG element in the coding region of exon 1. Mutations were introduced at the CACGTG element of pmimitin(W)luci as described previously (15), to produce pmimitin(mE)luci, in which CACGTG was mutated to CACCCG. pRL-CMV containing the *Renilla reniformis luciferase* gene under the control of a CMV promoter was purchased from Promega.

RNA preparation, differential display using a DNA chip (cDNA micro array), Northern blot analysis, and preparation of probe DNAs - Total RNA was isolated from cells as described previously (15). Poly(A⁺) RNA aliquots from T98Gmycer-2 cells untreated or treated with 4-hydroxytamoxifen (OHT) were subjected to differential display using a DNA chip (UniGEM Human V Ver. 2, Incyte Genomics, Palo Alto, CA) as described previously (15). Northern blot analysis was performed as described previously (15). The DNA probes for *c-myc* (12) and *glyceraldehyde-3-phosphate dehydrogenase (GAPDH)* (29) were described previously. The DNA probe for *mimitin* was a 0.5 kb *Eco*RI fragment of pCAGGS/mimitin.

Transient expression assay - A transient expression assay was performed basically as previously described (15). In brief, T98Gmycer-2 cells were plated into a dish and cultured in medium supplemented with 0.25% FCS for 20-24 h. One µg of the reporter plasmids and 20 ng of pRL-CMV as an internal transfection marker were transfected. Ten to 12 hours later, OHT was added to activate MycER chimeric protein, and cells were further cultured for 9-12 h. Cells were then collected and analyzed for luciferase activity.

Chromatin immunoprecipitation - Chromatin immunoprecipitation assay was performed as described previously (15), basically according to the methods described by Boyd et al. (30). Immunoprecipitated DNA fragments were detected by PCR, using the primers 5'-GTGGAGGGCAGTTATTCTTTGGAG-3' and 5'-GGGCTCTCACTTTTCCTTCCTTTA-3', which

amplified a 0.9 kb fragment containing the sequence of the promoter, exon 1 and part of intron 1 of the human *mimitin* gene. A DNA fragment of the human gene encoding the trifunctional enzyme carbamoyl-phosphate synthase/aspartate carbamoyltransferase/dihydroorotase (*cad*) was also amplified by PCR, using the primers described previously (31).

Antibodies - The GST fusion protein GST-Mimitin was expressed using pGEX/mimitin in *E. coli* JM109 and isolated by a glutathione Sepharose column (Amersham Biosciences), and further purified by SDS-PAGE. Rabbits were immunized with the recombinant polypeptide. Polyclonal anti-Mimitin antibody was purified from rabbit serum using Sepharose 4B conjugated with recombinant His x 6-tagged Mimitin polypeptide isolated by Nickel Column as described previously (15). Antibody-2 against c-Myc (12) and the antibody against mitochondrial protein (Tom22) (32) were described previously. Anti-c-Myc antibody-1 (N262) (Santa Cruz Biotechnology, Santa Cruz, CA), anti-MAPK/ERK-1 antibody (K-23) (Santa Cruz Biotechnology), anti-Tom20 mouse antibody (F-10) (Santa Cruz Biotechnology), goat anti-rabbit IgG-HRP antibody (Santa Cruz Biotechnology, Cat# sc-2054), Alexa 488-conjugated anti-rabbit IgG (Molecular Probes, Eugene, OR), Alexa 568-conjugated anti-mouse IgG (Molecular Probes), and anti-β-actin monoclonal antibody (AC-15) (Sigma-Aldrich Fine Chemicals, St. Louis, MO) were purchased.

Western blot analysis and indirect immunofluorescence staining - Cell lysates were extracted and analyzed by Western blotting as described previously (33). HeLa cells grown on glass coverslips were fixed in 4% paraformaldehyde in PBS for 30 min at room temperature, permeabilized with 1% Triton X-100 in PBS, stained with an indirect immunofluorescence staining technique and observed as described previously (15, 34).

T98G cells were fractionated into enriched mitochondrial and cytosolic fractions, using a mitochondria/cytosol fractionation kit (BioVision Research Products, Mountain View, CA, USA, Cat# K256-100).

Introduction of siRNA into cells - A small interference RNA molecule (siRNA) targeting human *c-myc* and a control siRNA (Ambion Austin, TX, cat# 4604) were purchased. The siRNA sequences targeting human *mimitin*, which are positions 72-90 (si-mimitin-1) and 330-348 (si-mimitin-2) relative to the first nucleotide of the start codon and the 2-nucleotide 3' overhang of deoxythymidine, were chemically synthesized (Hokkaido System Science, Sapporo, Japan). Transfection was carried out with 200 pmol siRNA per well using Oligofectamine (Invitrogen) as described previously (15).

Tissues and immunostaining - Routinely processed formalin-fixed and paraffin-embedded specimens from 35 Japanese patients with ESCC operated on from 1997 to 1998 at the Department of Surgery of Kurume University Hospital were used. One block containing a marginal region of tumor was selected from each patient. The specimens were assigned a TNM stage based on the UICC criteria for tumor classification (35). Haematoxylin and eosin (HE)-stained sections were also classified according to the histopathological grading system as well (G1, moderately (G2), or poorly (G3) differentiated. Histopathological grades and stagings were determined by two pathologists. The characteristics of the tissues are outlined in Supplemental information, Table S1. Immunostaining of tissues was performed essentially as described before (33). This study was approved by the institutional ethics review board of Kurume University.

For evaluation of the level of staining by antibodies, the most highly stained area of each section was scored on a scale from 0 to 4 by visual observation. To estimate the percentage of stained cells, the numbers of positive and negative cells in a field were counted and expressed as the percentage of cells stained. More than 500 cells in each section were counted. A staining index was calculated as staining intensity x average percentage of cells stained. Tissues were scored by two independent observers [N. A. and M. T.] without prior knowledge of the patients' other data with a very high correlation between scores ($P < 0.0001$).

Statistical analysis - The Mimitin staining index was compared with the cell proliferation index (the staining index for Ki-67), the staining index for c-Myc, histopathological grade, stage of cancer, and age of patient by the Spearman rank correlation coefficient and statistical test of independence, using the statistical analysis program StatView ver. 5 (SAS Institute, Cary, NC).

RESULTS

Identification of mimitin as a Myc-controlled gene - To conditionally induce c-Myc activity, the estrogen-inducible Myc system (12, 36, 37) was used. The chimeric protein c-MycER consists of c-Myc and the estrogen-binding domain of the estrogen receptor. c-MycER anchors to cytoskeletal components of cells in the absence of estrogen. When estrogen or its analog molecule 4-hydroxytamoxifen (OHT) binds to the chimeric protein, it becomes free to function as c-Myc. The human glioblastoma cell line T98G expressing c-MycER protein (T98Gmycer-2 cells) was established previously (15). Total RNAs from T98Gmycer-2 cells in an exponentially growing phase in the presence or absence of OHT for 20 h were processed by cDNA micro array analysis.

To shed light on a new facet of c-Myc functions, we focused on human EST sequences among genes stimulated by c-MycER activation. The signal for EST clone AI803230 was stimulated 2.2-fold with c-Myc activation. This stimulation rate was similar to those of the Myc target genes, *ODC* (2.6-fold), *nucleolin* (1.6-fold), and *mina53* (1.9-fold), measured in this study. cDNAs encoding the 5' upstream and 3' downstream parts of the EST clone AI803230 were isolated using the 5'-RACE and 3'-RACE protocols from a library of human erythroid leukemia cells. It was found that EST AI803230 includes part of the cDNA that encodes a protein of 169 amino acids with a predicted molecular weight of 19.9 kd (Fig. 1A).

When an antibody raised against this protein was used in Western blotting, a band of about 20 kd, which has a similar mobility to that predicted from the amino acid sequence, was detected in T98G cells (Fig. 1B left panel). When T98G cells were transfected with mammalian expression plasmids coding this protein or the c-myc-tagged

protein, this antibody recognized a 20 kd band with increased intensity and a slowly migrating band (Fig. 1B, right panel) in the cell lysates. As described later (Fig. 3), the treatment of cells with siRNAs specific for this gene specifically reduced the intensity of the band. These results indicate that this antibody specifically recognized the protein.

When c-MycER was activated in T98Gmycer-2 cells by OHT, the intensity of the band was increased, while that for β -actin was not (Fig. 1B). The c-MycER activation in T98Gmycer-2 cells had little effect on cell proliferation (data not shown). These results suggest that the expression of this protein can be induced by c-Myc without necessarily stimulating cell proliferation.

The subcellular localization of this protein was visualized by indirect immunofluorescence staining. As shown in Fig. 1C, the protein was present in the cytoplasmic region of cells with a maze-like localization. Double staining with antibodies against this protein and Tom20 (a component of the preprotein translocase of the outer membrane of mitochondria) (Fig. 1C) or cytochrome c (data not shown) indicated that the staining for this protein was mostly consistent with mitochondria. We also detected mitochondrial localization of this protein when the c-myc-tagged construct was transfected and the tagged-protein was detected by anti-Tag antibody (9E10) (data not shown). Therefore, we refer to this gene and the protein, respectively, as *mimitin* and Mimitin (Myc-induced mitochondrial protein).

We also used a biochemical approach to study Mimitin subcellular localization. Cells were fractionated into enriched mitochondria and cytosolic fractions, and analyzed by Western blotting using antibodies against Mimitin, a cytosolic protein (MAPK/ERK), and a mitochondrial protein (Tom22) (32). The results in Fig. 1D show that Mimitin was fractionated into the mitochondrial fraction but not into the cytosolic fraction, further supporting our observation that Mimitin is a mitochondrial protein.

Mimitin is conserved in human and mouse - Mouse cDNA that appears to be a homologue of human *mimitin* was found by a Blast search (GenBank accession No. AK007894). The predicted amino acid sequence for mouse Mimitin

was aligned with that of human Mimitin (Fig. 1A). The open reading frame (ORF) of mouse *mimitin* encodes a 168 amino acid protein. The human and mouse amino acid sequences of Mimitin proteins are 80% identical to each other, suggesting that *mimitin* is conserved in mammals. There is an ATP/GTP binding motif (P-loop within amino acid positions 146-153 in human Mimitin) in human and mouse Mimitin (Fig. 1A). A domain called Complex1_17_2kD (Fig. 1A, surrounded by a dotted line), was detected using the SMART program (38). The nucleotide 3 bp upstream of the methionine initiation codon is G in *mimitin* of both species, conforming to a Kozak consensus sequence (39).

Expression of mimitin mRNA - The expression profile of *mimitin* mRNA was examined. As shown in Fig. 2A, serum stimulation of serum-starved T98G cells resulted in a detectable increase at 6 h and a 3-fold increase in the expression of *mimitin* mRNA at 12-15 h. An increase of the *c-myc* mRNA level was detected at 3 h after serum addition. The expression of *glyceraldehyde-3-phosphate dehydrogenase* (*GAPDH*), which is widely used as a control, is high in cells overexpressing c-Myc, but is not directly controlled by c-Myc (40). By 9 h, the expression of *GAPDH* mRNA was almost unchanged, but a 2-fold increase was detectable at 12-15 h. These results suggest that up-regulation of *mimitin* mRNA followed the increase of *c-myc* mRNA, and preceded the increase of *GAPDH* mRNA.

In human promyelocytic leukemia HL60 cells, cell proliferation is arrested and the *c-myc* expression level is reduced by phorbol 12-myristate 13-acetate (TPA) (41, 42). This experimental system was used to investigate whether Myc-targeted genes are affected while Myc is shut off (15, 43). As shown in Fig. 2B, when HL60 cells were cultured with 10 nM TPA for 3 hours, the level of *c-myc* mRNA started to decline and reached one fifth at 7 h. Down-regulation of *mimitin* mRNA followed the decrease in *c-myc* mRNA, and the level of *mimitin* mRNA had decreased to one half and one third at 12 h and 24 h, respectively. The level of *GAPDH* mRNA had not changed at 12 h and had decreased to 60% only at 24 h. These experiments indicate that the down-regulation of *mimitin* expression

followed that of *c-myc* and preceded the decrease of *GAPDH* mRNA.

Next, the effect of c-Myc activation in c-MycER on *mimitin* mRNA was investigated (Fig. 2C). The *mimitin* mRNA level in OHT-treated T98Gmycer-2 cells rose steadily for 9 h, showing nearly 2-fold induction, although OHT-treatment of T98G parent cells did not stimulate the *mimitin* mRNA level. Induction of *mimitin* mRNA by OHT in T98Gmycer-2 cells was maintained in the presence of the protein-synthesis inhibitor cycloheximide (CHX), while treatment with CHX had little effect on the *mimitin* mRNA level in T98G parent cells. The *GAPDH* mRNA level did not change in this experiment. These results indicate that the *mimitin* gene is a direct target of Myc.

c-Myc stimulates the gene expression of mimitin through a mimitin genomic DNA fragment - We found the sequence for exon 1 of human *mimitin* in a genome data-base (AC073546; chromosome 5 clone RP11-406P13). More recently, human genomic DNA sequences, which include full-length *mimitin* cDNA sequences, were found by the UCSC Genome Browser, showing that the human *mimitin* gene maps to chromosome 5 (5q12.1). To investigate the promoter activity of the *mimitin* gene, a 0.7 kb human *mimitin* genomic DNA fragment containing upstream of exon 1, exon 1 and part of intron 1 was joined to firefly *luciferase* cDNA to construct a reporter plasmid, pmimitin(W)luci. Transient expression assays in T98Gmycer-2 cells indicate that the DNA fragment has promoter activity. After c-MycER activation by OHT, the luciferase activity was increased up to 1.8-fold (Fig. 2D, a bar for wild). This stimulation is comparable to that observed for an increase in *mimitin* mRNA level by OHT in T98Gmycer-2 cells (Fig. 2C).

Exon 1 has one E-box site (CACGTG element). When the CACGTG element was mutated to CACCCG, luciferase activity was not increased by the activation of c-MycER as a pGL3-Basic empty vector (Fig. 2D, bars for mutant and pBasic). These results indicate that c-Myc stimulates the expression of pmimitin(W)luci through the CACGTG element.

c-Myc binds to the mimitin gene in vivo - To examine c-Myc protein binding to the endogenous

mimitin gene during proliferation of HL60 cells, chromatin immunoprecipitation was performed as described previously (30, 44). After immunoprecipitation, enrichment of the endogenous *mimitin* gene fragment in each sample was monitored by PCR using primers that specifically amplify a *mimitin* DNA fragment, which containing the CACGTG element. As shown in Fig. 2E, two different anti-c-Myc antibodies immunoprecipitated the *mimitin* DNA fragment from HL60 cells in the proliferating phase, while the same antibodies did not immunoprecipitate detectable levels of DNA fragment from cells treated with TPA. Enrichment of the *mimitin* genomic DNA fragment is dependent on c-Myc binding to the *mimitin* gene, because a nonspecific antibody did not immunoprecipitate the *mimitin* DNA fragment. Additionally, binding of c-Myc detected in the *mimitin* gene is specific, because antibodies against c-Myc enriched the well-established Myc-target gene, *cad* (Fig. 2F), but did not enrich the genomic DNA fragment containing an E-box that is located in a chromosomal region without any detectable gene on chromosome 22 (Fig. 2E). These results demonstrate that the *mimitin* gene is bound by c-Myc specifically at the proliferating phase in HL60 cells.

Mimitin is involved in proliferation of some kinds of cultured cells - To gain insight into the biological function of *mimitin*, the expression of *mimitin* was specifically suppressed by the RNAi technique. As shown in Fig. 3A, the expression of Mimitin protein was reduced by siRNA specific for *mimitin* in colon carcinoma SW620, cervical carcinoma HeLa, ESCC TE-11, glioblastoma T98G, embryonic lung HEL, and hepatocellular carcinoma Kyn2 cells, while the expression of β -actin was not reduced in these cells. These results suggest that the siRNA specifically reduced the expression of Mimitin. However, the effect of the suppression of *mimitin* expression differed between cell lines. While specific inhibition of *mimitin* expression reduced cell proliferation of TE-11, T98G and HEL cells, it hardly affected cell proliferation of SW620, HeLa, and Kyn2 cells (Fig. 3B).

The levels of c-Myc protein in cell lines used here were compared by Western blotting. As shown in Fig. 3C, the two cell lines SW620 and

HeLa, which proliferated without being affected by *mimitin* knockdown, contained high levels of c-Myc. c-Myc protein levels were relatively low and similar in TE-11, T98G, and Kyn2 cells. In this group, *mimitin* knockdown suppressed cell proliferation in TE-11 and T98G cells, but not in Kyn2 cells. The c-Myc protein level was very low in HEL cells, whose cell proliferation was weakly suppressed by *mimitin* knockdown.

Among the cells, proliferation of ESCC TE-11 cells was most severely suppressed by the reduction of Mimitin expression. To confirm this result, the expression of Mimitin in TE-11 cells was specifically suppressed by another siRNA molecule targeting a different position from the first one. Two kinds of siRNA specific to *mimitin* reduced the expression of Mimitin protein (Fig. 3D). As shown in Fig. 3E, si-*mimitin*-2 suppressed cell proliferation more severely than si-*mimitin*-1 did, showing that the rate of suppression of cell proliferation was proportional to the reduction of Mimitin expression (Fig. 3D).

When expression of *c-myc* was specifically suppressed in TE-11 cells (Fig. 3D), the expression of Mimitin reduced (Fig. 3D) and cell proliferation was severely suppressed (Fig. 3E). These results suggest that *c-myc* is involved in cell proliferation and the expression of *mimitin* in ESCC cells.

Expression of Mimitin in ESCC tissues - To investigate whether *mimitin* is related to tumorigenesis of ESCC, tumors from surgical ESCC specimens were resected, and Mimitin was detected immunohistochemically. HE staining was used to demarcate tumor areas. The section shown in Fig. 4A contains a moderately differentiated ESCC. Fig. 4B shows marked staining for Mimitin in tumor areas. Staining for Mimitin was found in the cytoplasmic region of cells, consistent with our observation that Mimitin is a mitochondrial protein (Fig. 1C and D). Specific staining was not observed when the first antibody was omitted (Fig. 4C). Staining indices of Mimitin in non-neoplastic epithelial areas from 23 patients were determined, and the averaged index for non-neoplastic epithelial areas was 0.81. Next, staining indices of Mimitin for ESCCs were determined in 35 specimens (Supplemental information, Table S1). Twenty-eight out of 35 tumor specimens had staining indices higher than 0.81. Therefore, 80%

of the ESCC tissues highly expressed Mimitin, and high expression of Mimitin appears to be a characteristic feature of ESCC.

The level of Mimitin expression is related to cell proliferation - Because the expression levels of Mimitin differed between specimens, with staining indices from 0 to 3.92 (Supplemental information, Table S1), we investigated whether the level of Mimitin expression is associated with biological events in ESCC. When the staining indices of Mimitin were compared with the histopathological grade, stage of cancer, and age of patients (Supplemental information, Table S1), we did not observe any correlation (Table 1).

Next, the tissues were stained by anti-c-Myc antibody (Fig. 4D). The area stained by anti-c-Myc antibody overlapped well with that stained by anti-Mimitin antibody. When the staining indices of c-Myc were compared to those of Mimitin in 35 tumor tissues, a significant association was detected (Table 1). These results are consistent with our observation that *mimitin* is a Myc-target gene (Fig. 2).

Ki-67 is expressed in proliferating cells (45, 46), and anti-Ki-67 antibody is widely used to detect proliferating cells, including ESCC (47, 48). Fig. 4D shows that anti-Ki-67 antibody strongly stained the ESCC area, which was also stained by anti-Mimitin antibody (Fig. 4B). The staining indices of Mimitin correlated well with those of Ki-67 (Table 1). These results suggest that Mimitin is related to cell proliferation in ESCC.

DISCUSSION

Mimitin is a novel myc-target gene - We identified a novel gene, *mimitin*, which is up-regulated by c-Myc. The high conservation of amino acid sequences between human and mouse Mimitin suggests that *mimitin* has an important function in mammals. We showed here several lines of evidence that c-Myc directly induces the expression of *mimitin*. In brief, changes of *mimitin* expression followed those of *c-myc* (Fig. 2A and B). A significant association between Mimitin expression and c-Myc expression was observed in ESCC tissues (Fig. 4 and Table 1). Suppression of c-Myc expression by siRNA specific for *c-myc* reduced expression of Mimitin protein (Fig. 3D). When c-Myc was activated in the c-MycER

chimeric protein by OHT, stimulation of the expression of Mimitin protein (Fig. 1B) and *mimitin* mRNA (Fig. 2C) was observed. The stimulation of *mimitin* mRNA expression was maintained even in the presence of the protein synthesis inhibitor (Fig. 2C), suggesting that *mimitin* expression is directly controlled by c-Myc.

c-Myc protein binds to the endogenous *mimitin* genomic DNA that contains the CACGTG element in proliferating HL60 cells but not in HL60 cells treated with TPA (Fig. 2E and F). Experiments using reporter plasmids containing a human *mimitin* genomic DNA fragment suggest that c-Myc transactivates *mimitin* expression through the CACGTG element (Fig. 2D). Together, these results demonstrate that *mimitin* expression is controlled by c-Myc through the CACGTG element.

Mimitin protein is localized in mitochondria -

Double staining with antibodies to Mimitin and a mitochondrial protein indicate that Mimitin is localized in mitochondria (Fig. 1C). Analysis by the SMART program showed that Mimitin has a domain called Complex1_17_2kD. This domain was found in NADH-ubiquinone oxidoreductase subunit B17.2 (Complex I-B17.2 or DAP13, GenBank accession No. AAF91224) (49, 50), which was originally identified as a subunit of complex I involved in oxidative phosphorylation in bovine heart mitochondria. Only one putative orthologous protein for Mimitin and Complex I-B17.2 was found in *C. elegans* (Y94H6A.8, GenBank accession No. NP_500247) or *D. melanogaster* (CG3214, GenBank accession No. AAF51238), suggesting that Mimitin and Complex I-B17.2 originated from the same gene. These results suggest that Mimitin may be involved in ATP generation in mitochondria. However, the similarity between Mimitin and Complex I-B17.2 is weak (28% identical), and it is not possible to directly compare the function of Mimitin with that of Complex I-B17.2 because the function of Complex I-B17.2 has not yet been specified. Further studies are necessary to clarify the function of Mimitin.

Recently it was reported that several mitochondrial proteins are candidates for Myc-target genes (51, 52), suggesting that control of mitochondrial functions may be one of the

important classes of Myc-functions. Mitochondrial serine hydroxymethyl transferase (mSHMT), a major source of the one-carbon unit for cell metabolism, partially restored cell proliferation of the c-myc-null fibroblasts, and was reported to be a Myc target (53). Myc induces mitochondria-mediated apoptosis, and a mitochondrial peroxidase redox protein PRDX3 (Peroxiredoxin III) was shown to be a Myc target and involved in apoptosis (54). mSHMT and PRDX3 were found in *S. cerevisiae*, *C. elegans*, *D. melanogaster*, and mammals. Mimitin was required for some types of cells to proliferate. Mimitin and/or proteins with significant similarity to Mimitin have been found in *C. elegans*, *D. melanogaster*, and mammals, but not in *S. cerevisiae*. These results suggest that Myc elevates expression of a variety of mitochondrial proteins, which would contribute to the multi-functional character of Myc. Further thorough studies are necessary to provide a complete picture of Myc control of mitochondrial functions.

Mimitin and cell proliferation - Specific inhibition of *mimitin* expression by an RNA interference (RNAi) method severely suppressed cell proliferation in ESCC cells, which require c-myc for proliferation (Fig. 3). A clear correlation was found in ESCC tissues between the Mimitin staining index and cell proliferation and between the indices of Mimitin staining and c-Myc staining (Table 1). These results suggest that *mimitin* is involved in Myc-dependent cell proliferation in ESCC.

Mimitin siRNA reduced c-Myc levels in ESCC TE-11 cells (Fig. 3C). However, *mimitin* siRNA did not reduce c-Myc expression level in SW620 cells (data not shown), in which *mimitin* siRNA did not suppress cell proliferation (Fig. 3B). c-myc expression is associated with cell proliferation and is down-regulated in quiescent cells. Therefore, the reduced expression of c-Myc by *mimitin* siRNAs in TE-11 cells could be the indirect effect via the suppression of cell proliferation induced by *mimitin* siRNA.

The suppression of Mimitin expression did not reduce cell proliferation in some kinds of cultured cells (Fig. 3B). One possible reason is the existence of a functionally redundant protein. *Cyclin D2* is a well-established Myc-target gene. Mice lacking the *cyclin D2* gene grow into adults with few abnormalities (55), showing that cyclin

D2 is not always necessary for cell proliferation. The existence of the functionally redundant proteins cyclin D1 and cyclin D3 apparently can compensate for the absence of cyclin D2. Therefore, *cyclin D2* is a Myc target gene that is necessary only in specific types of cells, and *mimitin* appears to belong to this class of Myc-target genes. A protein homologous to Mimitin, Complex I-B17.2 (49) described above, may have a redundant function with Mimitin, and may be expressed in some cells that do not require Mimitin to proliferate.

Another possibility is the existence of a functionally redundant mechanism. The cell lines SW620 and HeLa, which were resistant to *mimitin* knockdown, expressed c-Myc highly compared to the other cell lines. Therefore, it is possible that overexpression of Myc triggers alternative Myc proliferating pathway(s), conferring resistance to *mimitin* knockdown. If Mimitin is involved in ATP generation, glycolysis is a candidate pathway. Because a number of glycolytic genes are up-regulated by c-Myc (40, 56) and elevation of the glycolysis level would produce an elevated amount ATP, the effect of *mimitin* knockdown may be blunted in Myc-overexpressing cells.

Mice lacking a myc-target gene *ODC* die in early embryogenesis (57). Loss of *ODC* in yeast results in a cessation of growth (58), and yeast cells lacking *RCC1*, a Myc-target gene (12), do not grow (59). These Myc-target genes appear to be generally important for all types of cells to proliferate. Thus, a treatment to inhibit the function of one of these general type Myc target genes in a body would suppress cell proliferation of not only cancer cells but also normal cells, and would have serious side effects. On the other hand,

the other class of Myc-target genes, such as *cyclin D2* and *mimitin*, are necessary for only specific types of cells to proliferate. Thus, inhibition of the function of one of these specific Myc-target genes may hamper only some restricted types of cells and would have fewer side effects and more potential than a general type for cancer therapy. Further identification and characterization of these specific Myc-target genes may lead to the discovery of new methods for cancer therapy and would help elucidate the mechanisms by which Myc controls cell proliferation in the highly complex animal system.

ACKNOWLEDGEMENT

We thank Mr. Shigeo Kamimura for preparing serial sections of tissues and Miss Yasuko Noguchi for her technical assistance. We thank Dr. Tetsuro Nishihira (Double-Barred Cross Hospital Japan Anti-Tuberculosis Association) and the Cell Resource Center for Biomedical Research, Institute of Development, Aging and Cancer, Tohoku University for providing human esophageal squamous cell carcinoma cell line TE-11. We thank Dr. Katsuyoshi Mihara (Kyushu University) for his kind help in determining the subcellular localization of Mimitin, and Dr. Yoshihiro Yoneda (Osaka University) for his critical reading of the manuscript. We thank Drs. Kathryn E. Boyd and Peggy J. Farnham for sending us their protocols for chromatin immunoprecipitation analysis. This work was supported by Grants-in-Aid from the Ministry of Education, Science, and Culture of Japan (Grant #16570164) and the Osaka Cancer Research Foundation.

REFERENCES

1. DePinho, R. A., Schreiber-Agus, N., and Alt, F. W. (1991) *Adv. Cancer Res.* **57**, 1-46.
2. Marcu, K. B., Bossone, S. A., and Patel, A. J. (1992) *Annu. Rev. Biochem.* **61**, 809-860.
3. Morgenbesser, S. D., and DePinho, R. A. (1994) *Semin. Cancer Biol.* **5**, 21-36.
4. Henriksson, M., and Lüscher, B. (1996) *Adv. Cancer Res.* **68**, 109-182.
5. Grandori, C., Cowley, S. M., James, L. P., and Eisenman, R. N. (2000) *Annu. Rev. Cell Dev. Biol.* **16**, 653-699.
6. Stanton, B. R., Perkins, A. S., Tessarollo, L., Sassoon, D. A., and Parada, L. F. (1992) *Genes Dev.* **6**, 2235-2247.
7. Sawai, S., Shimono, A., Wakamatsu, Y., Palmes, C., Hanaoka, K., and Kondoh, H. (1993) *Development* **117**, 1445-1455.
8. Davis, A. C., Wims, M., Spotts, G. D., Hann, S. R., and Bradley, A. (1993) *Genes Dev.* **7**, 671-682.
9. Lüscher, B. (2001) *Gene* **277**, 1-14.

10. Dang, C. V. (1999) *Mol. Cell. Biol.* **19**, 1-11.
11. Bello-Fernandez, C., Packham, G., and Cleveland, J. L. (1993) *Proc. Natl. Acad. Sci. USA* **90**, 7804-7808.
12. Tsuneoka, M., Nakano, F., Ohgusu, H., and Mekada, E. (1997) *Oncogene* **14**, 2301-2311.
13. Greasley, P. J., Bonnard, C., and Amati, B. (2000) *Nucleic Acids Res.* **28**, 446-453.
14. Bouchard, C., Dittrich, O., Kiermaier, A., Dohmann, K., Menkel, A., Eilers, M., and Lüscher, B. (2001) *Genes Dev.* **15**, 2042-2047.
15. Tsuneoka, M., Koda, Y., Soejima, M., Teye, K., and Kimura, H. (2002) *J. Biol. Chem.* **277**, 35450-35459.
16. Albertsson, M. (2002) *Acta Oncol.* **41**, 118-123.
17. Mandard, A. M., Hainaut, P., and Hollstein, M. (2000) *Mutat. Res.* **462**, 335-342.
18. Yoshida, K., Kawami, H., Yamaguchi, Y., Kuniyasu, H., Nishiyama, M., Hirai, T., Yanagihara, K., Tahara, E., and Toge, T. (1995) *Cancer* **75**, 1467-1471.
19. Wang, D. Y., Xiang, Y. Y., Tanaka, M., Li, X. R., Li, J. L., Shen, Q., Sugimura, H., and Kino, I. (1994) *Cancer* **74**, 3089-3096.
20. Kanda, Y., Nishiyama, Y., Shimada, Y., Imamura, M., Nomura, H., Hiai, H., and Fukumoto, M. (1994) *Int. J. Cancer* **58**, 291-297.
21. Coggi, G., Bosari, S., Roncalli, M., Graziani, D., Bossi, P., Viale, G., Buffa, R., Ferrero, S., Piazza, M., Blandamura, S., Segalin, A., Bonavina, L., and Peracchia, A. (1997) *Cancer* **79**, 425-432.
22. Ikeda, G., Isaji, S., Das, B. C., Watanabe, M., and Kawarada, Y. (1999) *Cancer* **86**, 1396-1405.
23. Nishihira, T., Katayama, M., Hashimoto, Y., and Akaishi, T. (1994) *Cell lines from esophageal tumors*. Atlas of human tumor cell lines (Hay, R., Park, J.-G., and Gazdar, A. F., Eds.), Academic Press, San Diego
24. Tsuneoka, M., Fujita, H., Arima, N., Teye, K., Okamura, T., Inutsuka, H., Koda, Y., Shirouzu, K., and Kimura, H. (2004) *Clin. Cancer Res.* **10**, 7347-7356.
25. Yano, H., Maruiwa, M., Murakami, T., Fukuda, K., Ito, Y., Sugihara, S., and Kojiro, M. (1988) *Acta Pathol. Jpn.* **38**, 953-966.
26. Mekada, E., Kohno, K., Ishiura, M., Uchida, T., and Okada, Y. (1982) *Biochem. Biophys. Res. Commun.* **109**, 792-799.
27. Koda, Y., Soejima, M., and Kimura, H. (1997a) *J. Biol. Chem.* **272**, 7501-7505.
28. Niwa, H., Yamamura, K., and Miyazaki, J. (1991) *Gene* **108**, 193-199.
29. Koda, Y., Soejima, M., Wang, B., and Kimura, H. (1997b) *Eur. J. Biochem.* **246**, 750-755.
30. Boyd, K. E., Wells, J., Gutman, J., Bartley, S. M., and Farnham, P. J. (1998) *Proc. Natl. Acad. Sci. USA* **95**, 13887-13892.
31. Eberhardy, S. R., D' Cunha, C. A., and Farnham, P. J. (2000) *J. Biol. Chem.* **275**, 33798-33805.
32. Saeki, K., Suzuki, H., Tsuneoka, M., Maeda, M., Iwamoto, R., Hasuwa, H., Shida, S., Takahashi, T., Sakaguchi, M., Endo, T., Miura, Y., Mekada, E., and Mihara, K. (2000) *J. Biol. Chem.* **275**, 31996-32002.
33. Teye, K., Tsuneoka, M., Arima, N., Koda, Y., Nakamura, Y., Ueta, Y., Shirouzu, K., and Kimura, H. (2004) *Am. J. Pathol.* **164**, 205-216.
34. Tsuneoka, M., and Mekada, E. (1992) *J. Biol. Chem.* **267**, 9107-9111.
35. Sobin, L. H., and Wittekind Ch. (2002) *UICC(International Union Against Cancer) edited by L. H. Sobin and Ch. Wittekind. TNM classification of malignant tumors*, Sixth Ed., John Wiley & Sons, New York
36. Eilers, M., Picard, D., Yamamoto, K. R., and Bishop, J. M. (1989) *Nature* **340**, 66-68.
37. Tsuneoka, M., and Mekada, E. (2000) *Oncogene* **19**, 115-123.
38. Letunic, I., Copley, R. R., Schmidt, S., Ciccarelli, F. D., Doerks, T., Schultz, J., and Ponting, C. P. (2004) *Nucleic Acids Res.* **32**, D142-D144.
39. Kozak, M. (1989) *J. Cell Biol.* **108**, 229-241.
40. Osthus, R. C., Shim, H., Kim, S., Li, Q., Reddy, R., Mukherjee, M., Xu, Y., Wonsey, D., Lee, L. A., and Dang, C. V. (2000) *J. Biol. Chem.* **275**, 21797-21800.

41. Hozumi, M. (1983) *Adv. Cancer Res.* **38**, 121-169.
42. Hickstein, D. D., Back, A. L., and Collins, S. J. (1989) *J. Biol. Chem.* **264**, 21812-21817.
43. Coller, H. A., Grandori, C., Tamayo, P., Colbert, T., Lander, E. S., Eisenman, R. N., and Golub, T. R. (2000) *Proc. Natl. Acad. Sci. USA* **97**, 3260-3265.
44. Boyd, K. E., and Farnham, P. J. (1997) *Mol. Cell. Biol.* **17**, 2529-2537.
45. Gerdes, J., Lemke, H., Baish, H., Wachter, H.-H., Schwab, U., and Stein, H. (1984) *J. Immunol.* **133**, 1710-1715.
46. Cattoretti, G., Becker, M. H., Key, G., Duchrow, M., Schluter, C., Galle, J., and Gerdes, J. (1992) *J. Pathol.* **168**, 357-363.
47. Youssef, E. M., Matsuda, T., Takada, N., Osugi, H., Higashino, M., Kinoshita, H., Watanabe, T., Katsura, Y., Wanibuchi, H., and Fukushima, S. (1995) *Cancer Res.* **55**, 358-366.
48. Porschen, R., Classen, S., Piontek, M., and Borchard, F. (1994) *Cancer Res.* **54**, 587-591.
49. Skehel, J. M., Fearnley, I. M., and Walker, J. E. (1998) *FEBS Lett.* **438**, 301-305.
50. Triepels, R., Smeitink, J., Loeffen, J., Smeets, R., Trijbels, F., and von den Heuvel, L. (2000) *Hum. Genet.* **106**, 385-391.
51. Morrish, F., Giedt, C., and Hockenbery, D. (2003) *Genes Dev.* **17**, 240-255.
52. Orian, A., von Steensel, B., Delrow, J., Bussemaker, H. J., Li, L., Sawado, T., Williams, E., Loo, L. W., Cowley, S. M., Yost, C., Pierce, S., Edgar, B. A., Parkhurst, S. M., and Eisenman, R. N. (2003) *Genes Dev.* **17**, 1101-1104.
53. Nikiforov, M. A., Chandriani, S., O'Connell, B., Petrenko, O., Kotenko, I., Beavis, A., Sedivy, J. M., and Cole, M. D. (2002) *Mol. Cell. Biol.* **22**, 5793-5800.
54. Wonsey, D. R., Zeller, K. I., and Dang, C. V. (2002) *Proc. Natl. Acad. Sci. USA* **99**, 6649-6654.
55. Sicinski, P., Donaher, J. L., Geng, Y., Parker, S. B., Gardner, H., Park, M. Y., Robker, R. L., Richards, J. S., McGinnis, L. K., Biggers, J. D., Eppig, J. J., Bronson, R. T., Elledge, S. J., and Weinberg, R. A. (1996) *Nature* **384**, 470-474.
56. Kim, J. W., Zeller, K. I., Wang, Y., Jegga, A. G., Aronow, B. J., O'Donnell, K. A., and Dang, C. V. (2004) *Mol. Cell. Biol.* **24**, 5923-5936.
57. Pendeville, H., Carpino, N., Marine, J. C., Takahashi, Y., Muller, M., Martial, J. A., and Cleveland, J. L. (2001) *Mol. Cell. Biol.* **21**, 6549-6558.
58. Schwartz, B., Hittelman, A., Daneshvar, L., Basu, H. S., Marton, L. J., and Feuerstein, B. G. (1995) *Biochem. J.* **312**, 83-90.
59. Demeter, J., Morphew, M., and Sazer, S. (1995) *Proc. Natl. Acad. Sci. USA* **92**, 1436-1440.

FOOTNOTES

The nucleotide sequences studied here were deposited in the GenBank database: cDNA sequence for human Mimitin, AB183433; DNA sequence for the *mimitin* gene promoter, AB183435; cDNA sequence for mouse Mimitin, AB183434. During our experiments, similar sequences for human *mimitin* were deposited in the GenBank database (LOC361894).

The abbreviations used are: ESCC, esophageal squamous cell carcinoma; PBS, phosphate buffered saline; ODC, ornithine decarboxylase; OHT, 4-hydroxytamoxifen; CHX, cycloheximide; RNAi, the RNA interference; GAPDH, glyceraldehyde-3-phosphate dehydrogenase; cad, the trifunctional enzyme carbamoyl-phosphate synthase/aspartate carbamoyltransferase/dihydroorotase.

FIGURE LEGENDS

Fig. 1. Amino acid sequence, expression, and subcellular localization of Mimitin protein. A, Amino acid sequence of human Mimitin protein, which was predicted from the cDNA isolated in this study, is shown. Only those residues of the mouse protein that are divergent are shown below. The ATP/GTP-binding site motif A (P-loop) and a region called Complex1_17_2kD domain are surrounded by solid and dotted lines, respectively. B, Western blotting analysis of Mimitin. T98G and T98Gmycer-2 cells were cultured in the presence or absence of 0.2 μ M OHT for 40 h (left panel). T98G cells were transfected with a Mimitin expression plasmid (mimitin), c-myc-tagged Mimitin expression vector (mimitin-mychis), or control vector (contr) (right panel). Lysates from these cells were subjected to Western blotting using a specific antibody against Mimitin protein (upper panel). The blotting membrane detecting Mimitin was re-probed with anti- β -actin antibody (lower panel). The same amounts of protein analyzed by Western blotting were electrophoresed and stained for total protein to confirm that a similar amount of the protein was analyzed in this study (data not shown). C, The subcellular localization of human Mimitin protein. The localization of Mimitin in HeLa cells was visualized by indirect immunofluorescence staining with antibodies against Mimitin (Mimitin) and Tom20 (Tom20). An overlapped image is also shown (merge). Scale bars, 20 μ m. D, T98G cells were fractionated into cytosolic and mitochondrial fractions, and analyzed by Western blotting using antibodies against Mimitin, MAPK/ERK, and Tom22.

Fig. 2. Control of *mimitin* expression by c-Myc. A-C, RNA was isolated at the indicated time points, and then analyzed by Northern blotting to detect *mimitin*, *c-myc* (except C), and GAPDH mRNA. 28S and 18S ribosomal RNAs are also shown. Serum-starved T98G cells were stimulated by the addition of serum at a final concentration of 10% (A). Human promyelocytic leukemia HL60 cells were exposed to 10 nM TPA (B). After T98Gmycer-2 cells (mycer) and parental T98G cells (contr) were cultured in the medium supplemented with 0.25% serum for 40 h, cells were treated with 200 nM 4-hydroxytamoxifen (OHT) to activate c-MycER. When indicated as +, 20 μ g/ml cycloheximide (CHX) was added 20 min before the addition of OHT (C). D, Transient expression assay for the *mimitin* promoter. The reporter plasmid (pmimitin(W)luci, wild) was constructed from a DNA fragment of *mimitin* (containing upstream of exon 1, exon 1 and part of intron 1) that contained a CACGTG element and firefly *luciferase*. The CACGTG element was mutated to CACCCG in pmimitin(mE)luci (mutant). After normalization, firefly luciferase activities were expressed as the ratio to activities without MycER activation. Values are the means of four separate experiments. The bars indicate the standard errors. E and F, Chromatin immunoprecipitation experiments. HL60 cells in the proliferating phase (-TPA) and those treated with 10 nM TPA for 24 h (+TPA) were fixed with 1% formaldehyde, nuclear extracts were collected, and chromatin fragments were immunoprecipitated using antibodies against c-Myc (anti-c-Myc antibody-1 and anti-c-Myc antibody-2), control antibody, or no antibody (- antibody). Mock immunoprecipitation, in which no nuclear extracts were added, was also performed (- nuclear extract). Following DNA purification, samples were subjected to PCR with primers designed to amplify a DNA fragment of the *mimitin* gene (mimitin primers) or primers to specifically amplify a DNA fragment containing a chromosome 22 E-box (control primers) (14, 15) (E), and with the mimitin primers or primers to specifically amplify a DNA fragment containing the *cad* gene (cad primers) (F).

Fig. 3. Mimitin is involved in cell proliferation of cultured ESCC cells. A, Reduction of Mimitin protein expression by siRNA specific to *mimitin*. Human cells, colon adenocarcinoma SW620, cervical carcinoma HeLa, esophageal squamous cell carcinoma TE-11, glioblastoma T98G, human embryonic lung HEL, and hepatocellular carcinoma Kyn2 were transfected with siRNA specific to *mimitin* (si-mimitin-2) or control siRNA (contr) without serum. Forty hours after adding serum, cells were collected, and cell extracts from the same number of cells in each set were analyzed by Western blotting using anti-Mimitin and anti- β -actin antibodies. B, Cells in (A) were transfected with si-mimitin-2 (●) or a control siRNA (○) without serum. Then cells were cultured in the presence of serum (arrow) from day 0, and cell numbers were counted on various days and expressed on the y-axis. Experiments were performed at least 3 times, and

error bars are shown. C, c-Myc protein expression. Cells used here were collected, lysed, and the protein concentration was determined. Similar amounts of protein were analyzed by Western blotting using anti-c-Myc antibody. The blotting membrane was re-probed with anti- β -actin antibody. D, Reduction of Mimitin protein expression by siRNA specific to *c-myc* or *mimitin* in ESCC cell line TE-11. Cells were transfected with a control siRNA (contr), an siRNA duplex specific for *c-myc* (myc), and siRNA duplexes specific for *mimitin*, si-mimitin-1, or si-mimitin-2 (mimitin-1 or mimitin-2, respectively) without serum. Forty hours after adding serum, cell extracts were processed for Western blot analysis using anti-c-Myc and anti-Mimitin antibodies. The blotting membrane detecting Mimitin was re-probed with anti- β -actin antibody. Aliquots of the same amounts were electrophoresed, transferred, and stained for protein to confirm that similar amounts of proteins were used in this experiment (data not shown). E, Cell proliferation of siRNA transfected TE-11 cells. TE-11 cells were transfected with siRNA duplexes specific for *mimitin* (si-mimitin-1 (◆) and si-mimitin-2 (▲)), *c-myc* (●) or a control siRNA (○) without serum. Then cells were cultured in the presence of serum (arrow) from day 0. On various days, cell numbers were counted and expressed on the y-axis. Experiments were performed 3 times, and error bars are shown.

Fig. 4. Expression of Mimitin, c-Myc and Ki-67 in surgically resected human ESCC tissues. A, HE staining of a section that contained moderately differentiated ESCC. B, A serial section of (A) stained by anti-Mimitin antibody showing the expression of Mimitin in the tumor area. C, A control serial section, in which the primary antibody was omitted. D, A serial section of (A) stained by anti-c-Myc antibody. E, A serial section of (A) stained by anti-Ki-67 antibody. Positive staining is brown and counterstained nuclei are blue (B-E). Scale bars, 50 μ m.

Table 1. Relationship between expression of Mimitin and biological events in ESCC. The Mimitin staining index was statistically compared with histopathological grade, stage of cancer, age of patient, the staining index for c-Myc, and the cell proliferation index (the staining index for Ki-67).

Factor	r	P
Histopathological grade	0.070	0.6901
Stage of cancer	0.131	0.4545
Age of patients	-0.069	0.6973
Staining index of c-Myc	0.435	0.0084
Cell proliferation (staining index of Ki-67)	0.728	<0.0001

Figure 1

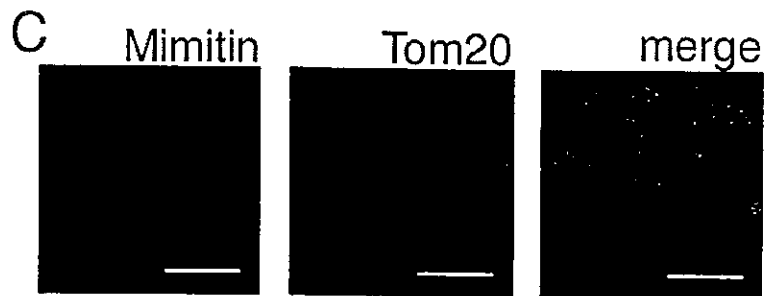
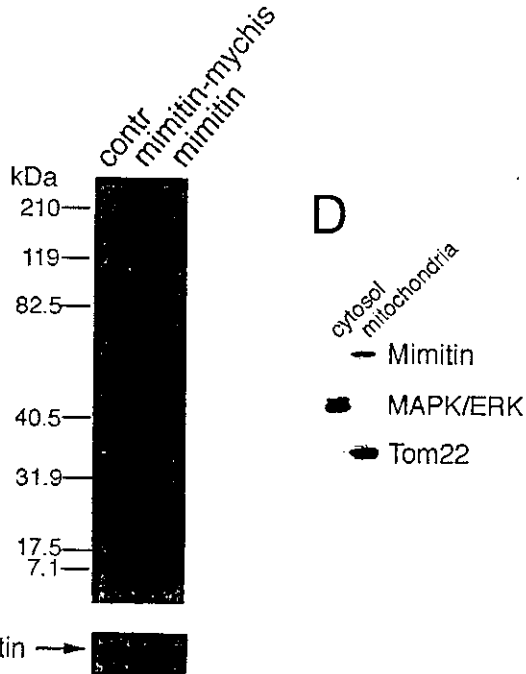
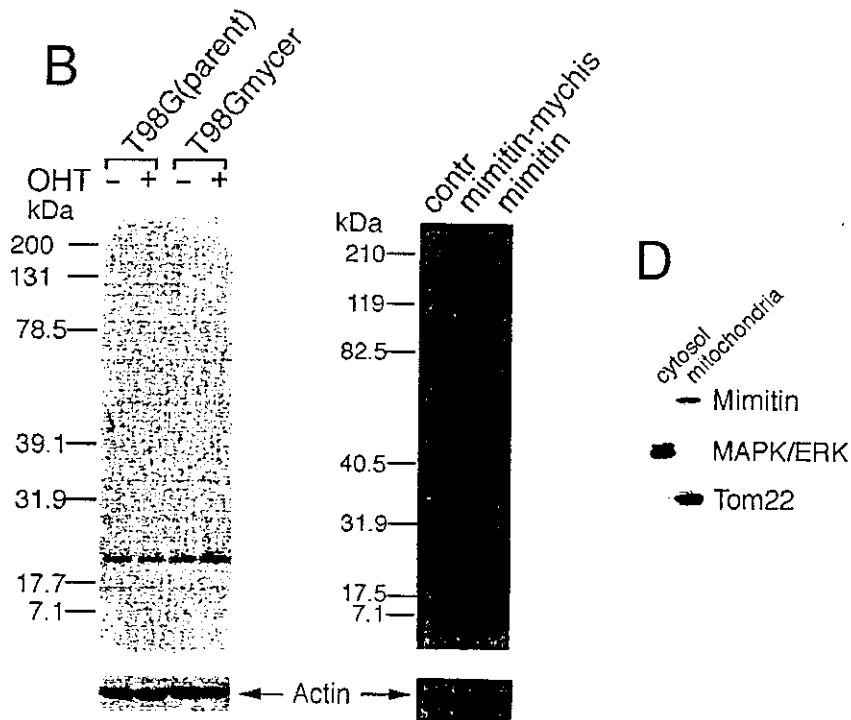
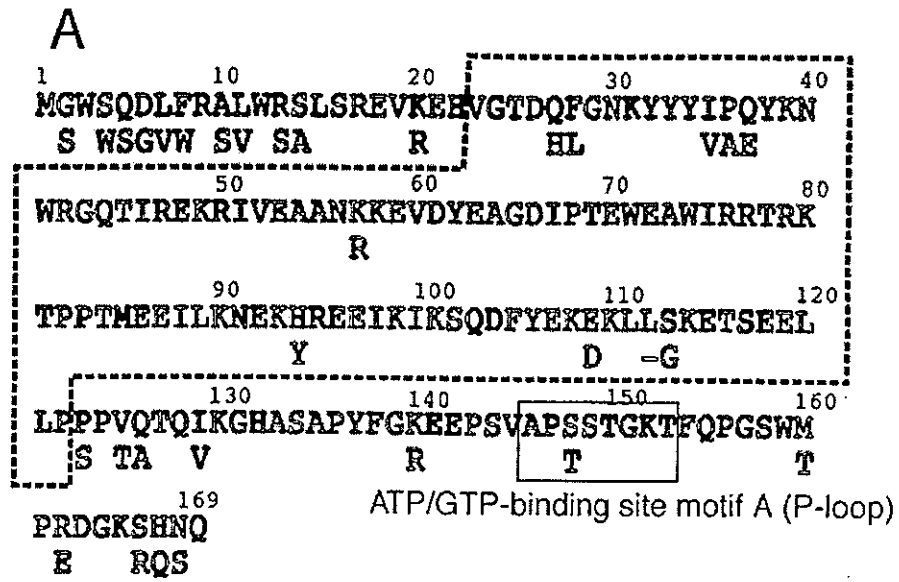

Figure 2

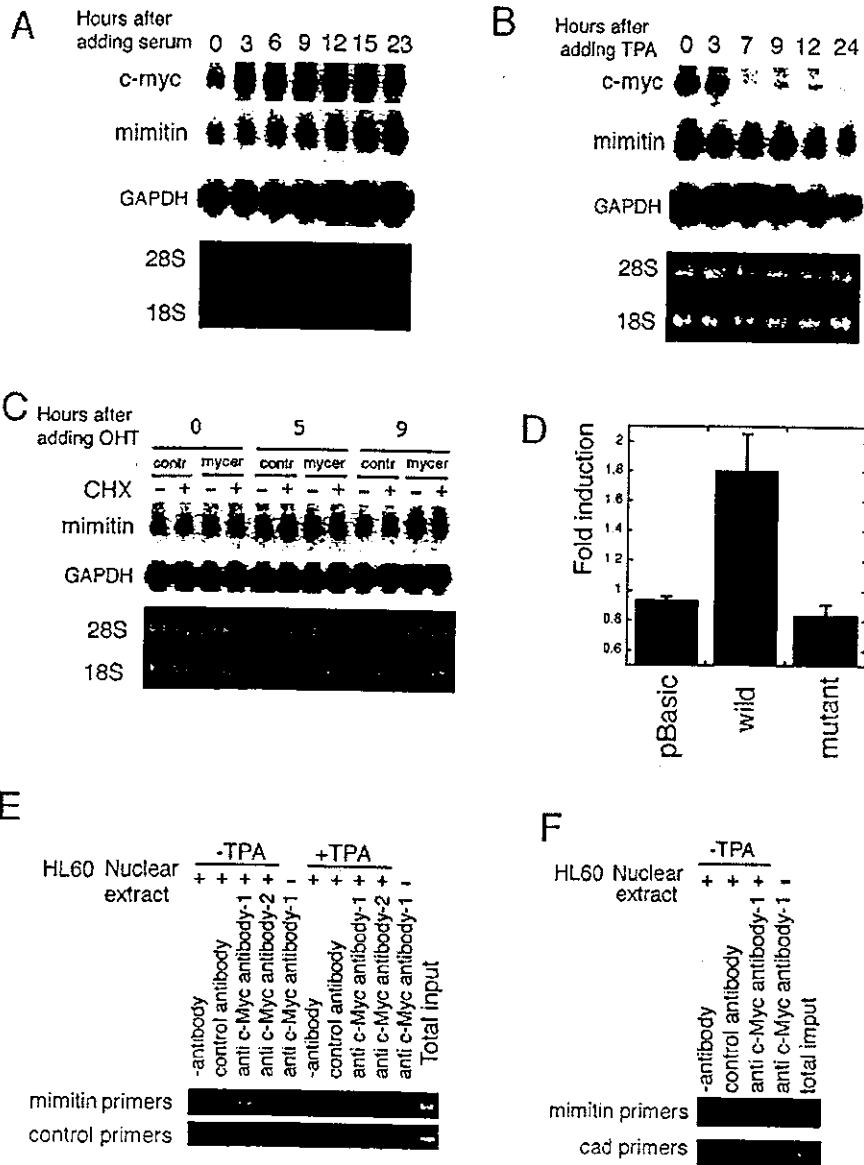

Figure 3

